

<b>Last Modified:</b> 12-04-2024	6.11:8.1.0	<b>Doc ID:</b> RM100000002B7BL
<b>Model Year Start:</b> 2023	<b>Model:</b> Prius Prime	<b>Prod Date Range:</b> [03/2023 - ]
<b>Title:</b> HYBRID / BATTERY CONTROL: SERVICE PLUG GRIP (for PHEV Model): REMOVAL; 2023 - 2024 MY Prius Prime [03/2023 - ]		

## REMOVAL

### CAUTION / NOTICE / HINT

The necessary procedures (adjustment, calibration, initialization or registration) that must be performed after parts are removed and installed, or replaced during service plug grip removal/installation are shown below.

#### Necessary Procedures After Parts Removed/Installed/Replaced

REPLACED PART OR PERFORMED PROCEDURE	NECESSARY PROCEDURE	EFFECT/INOPERATIVE FUNCTION WHEN NECESSARY PROCEDURE NOT PERFORMED	LINK
Replacement of service plug grip	High voltage fuse accumulated load history reset	DTCs are stored	<a href="#">INFO</a>

**CAUTION:**

- Orange wire harnesses and connectors indicate high-voltage circuits. To prevent electric shock, always follow



the procedure described in the repair manual.

[Click here](#) [INFO](#)

- To prevent electric shock, wear insulated gloves when working on wire harnesses and components of the high



voltage system.

**NOTICE:**

After turning the ignition switch off, waiting time may be required before disconnecting the cable from the negative (-) auxiliary battery terminal.

Click here [INFO](#)

**HINT:**

When the cable is disconnected / reconnected to the auxiliary battery terminal, systems temporarily stop operating. However, each system has a function that completes learning the first time the system is used.

**Items for which learning is completed by driving the vehicle**

EFFECT/INOPERATIVE FUNCTION WHEN NECESSARY PROCEDURE NOT PERFORMED	NECESSARY PROCEDURE	LINK
Front Camera System	Drive the vehicle straight ahead at 35 km/h (22 mph) or more for 5 seconds or more.	<a href="#">INFO</a>

**Items for which learning is completed by operating the vehicle normally**

EFFECT/INOPERATIVE FUNCTION WHEN NECESSARY PROCEDURE NOT PERFORMED	NECESSARY PROCEDURE	LINK
Power Door Lock Control System*1 <ul style="list-style-type: none"> <li>Back door opener</li> </ul>	Perform door unlock operation with door control switch or electrical key transmitter sub-assembly switch.	<a href="#">INFO</a>
Power Back Door System*2	Reset back door close position	<a href="#">INFO</a>
Air Conditioning System	After the ignition switch is turned to ON, the servo motor and expansion valve standard position is recognized.	-
*1: w/o Power Back Door System		
*2: w/ Power Back Door System		

**CAUTION / NOTICE / HINT**

**COMPONENTS (REMOVAL)**

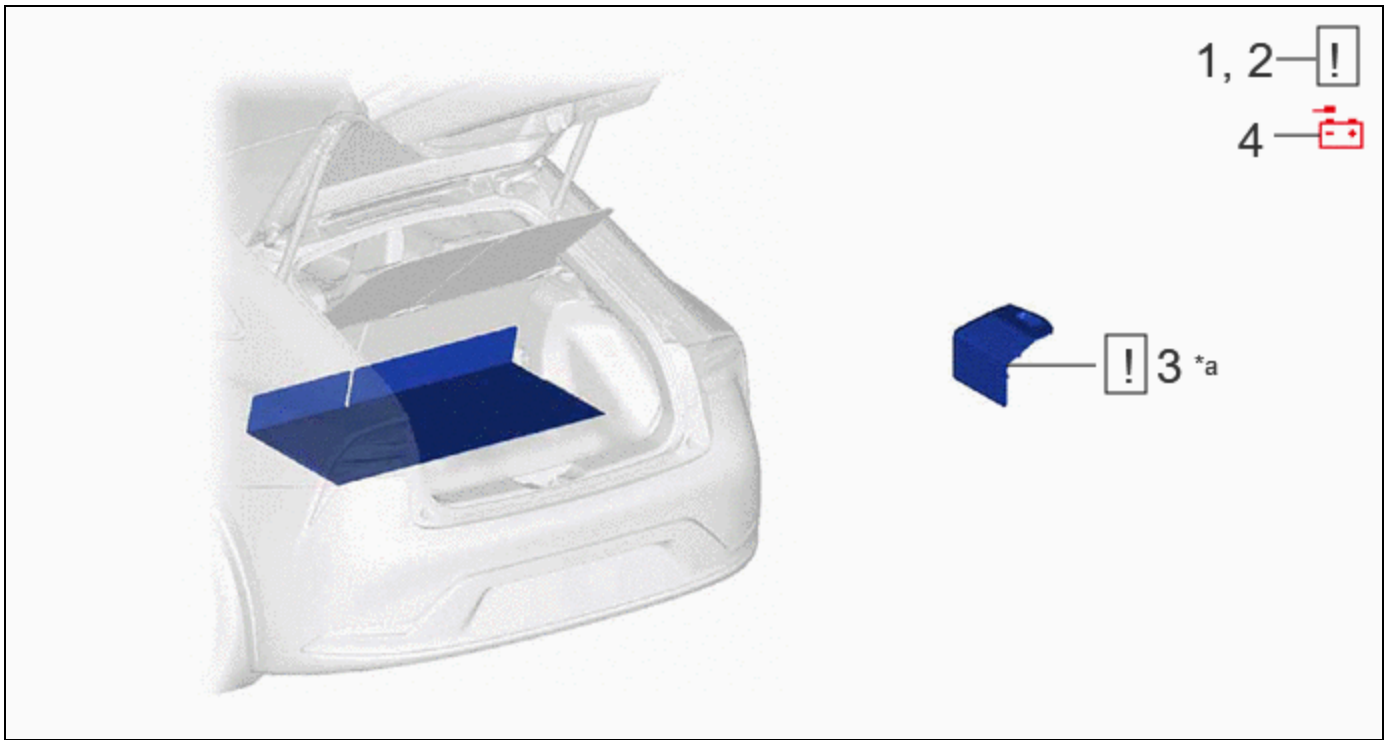

PROCEDURE		PART NAME CODE			
1	PRECAUTION	-	<a href="#">INFO</a>	-	-
2	CHECK FOR DTC	-	<a href="#">INFO</a>	-	-
3	BATTERY SERVICE HOLE COVER ASSEMBLY	58440	<a href="#">INFO</a>	-	-
4	NEGATIVE AUXILIARY BATTERY TERMINAL	-	-	-	-

*a	<p><b>HINT:</b> As the illustration shown is an example, the actual details may differ.</p>	-	-
----	---	---	---

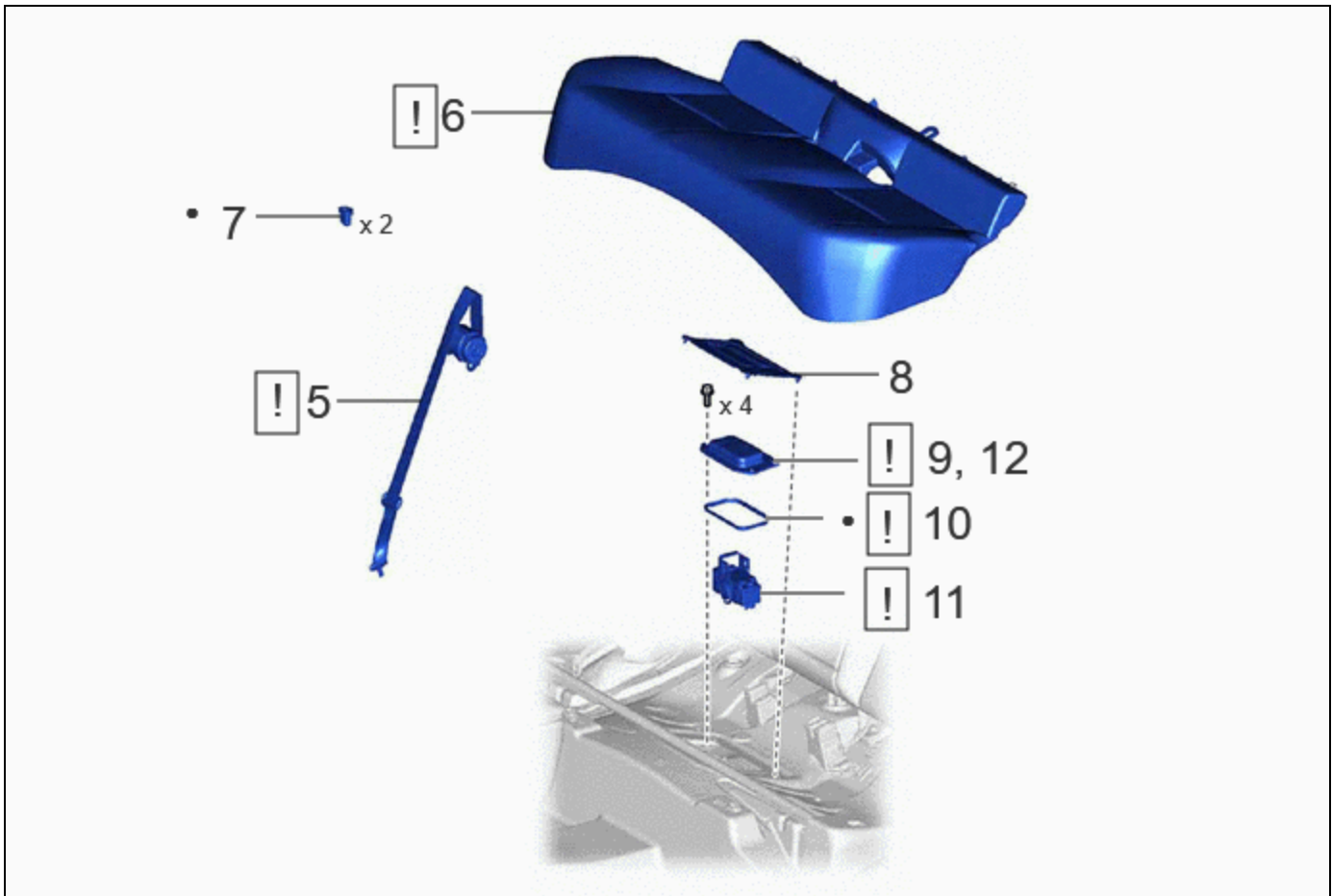

PROCEDURE		PART NAME CODE			
5	REAR CENTER SEAT OUTER BELT ASSEMBLY	73350C	<a href="#">INFO</a>	-	-
6	REAR SEAT CUSHION ASSEMBLY	-	<a href="#">INFO</a>	-	-
7	REAR SEAT CUSHION LOCK HOOK	72693	-	-	-
8	REAR FLOOR SERVICE HOLE COVER	58325E	-	-	-
9	REMOVE NO. 2 TRACTION BATTERY COVER	G9622	<a href="#">INFO</a>	-	-
10	NO. 1 HYBRID BATTERY REAR SHIELD SEAL	G92DF	<a href="#">INFO</a>	-	-
11	SERVICE PLUG GRIP	G3834	<a href="#">INFO</a>	-	-
12	TEMPORARILY INSTALL NO. 2 TRACTION BATTERY COVER	G9622	<a href="#">INFO</a>	-	-

•	Non-reusable part	-	-
---	-------------------	---	---

## PROCEDURE

### 1. PRECAUTION

	Click here <a href="#">INFO</a>
---	---------------------------------

## 2. CHECK FOR DTC

(a) Check for DTCs.

### CAUTION:

- Confirm that DTC P0AA649 (Hybrid / EV Battery Voltage System Isolation Internal Electronic Failure), P1C7C49 (Hybrid / EV Battery Voltage System Isolation (A/C Area) Internal Electronic Failure), P1C7D49 (Hybrid / EV Battery Voltage System Isolation (Hybrid/EV Battery Area) Internal Electronic Failure), P1C7E49 (Hybrid / EV Battery Voltage System Isolation (Transaxle Area) Internal Electronic Failure) or P1C7F49 (Hybrid / EV Battery Voltage System Isolation (Direct Current Area) Internal Electronic Failure), P1C8049 (Hybrid/EV Battery Voltage System Isolation (Rear Motor Area) Internal Electronic Failure, for 4WD/AWD), P1CF749 (Hybrid/EV Battery Voltage System Isolation (Charger Area) Internal Electronic Failure), P33CF49 (Hybrid/EV Battery Voltage System Isolation Internal Electronic Failure Abnormal Area Detection Failure) is not output before removing or installing the HV battery. If this DTC is output, perform troubleshooting for this DTC first.



- To reduce the risk of electric shock, do not perform troubleshooting before checking for DTCs.

## 3. REMOVE BATTERY SERVICE HOLE COVER ASSEMBLY

	Click here <a href="#">INFO</a>
---	---------------------------------

## 4. DISCONNECT CABLE FROM NEGATIVE AUXILIARY BATTERY TERMINAL

Click here [INFO](#)

## 5. REMOVE REAR CENTER SEAT OUTER BELT ASSEMBLY

	Click here <a href="#">INFO</a>
---	---------------------------------

### 6. REMOVE REAR SEAT CUSHION ASSEMBLY

	Click here <a href="#">INFO</a>
---	---------------------------------

### 7. REMOVE REAR SEAT CUSHION LOCK HOOK

Click here [INFO](#)

### 8. REMOVE REAR FLOOR SERVICE HOLE COVER

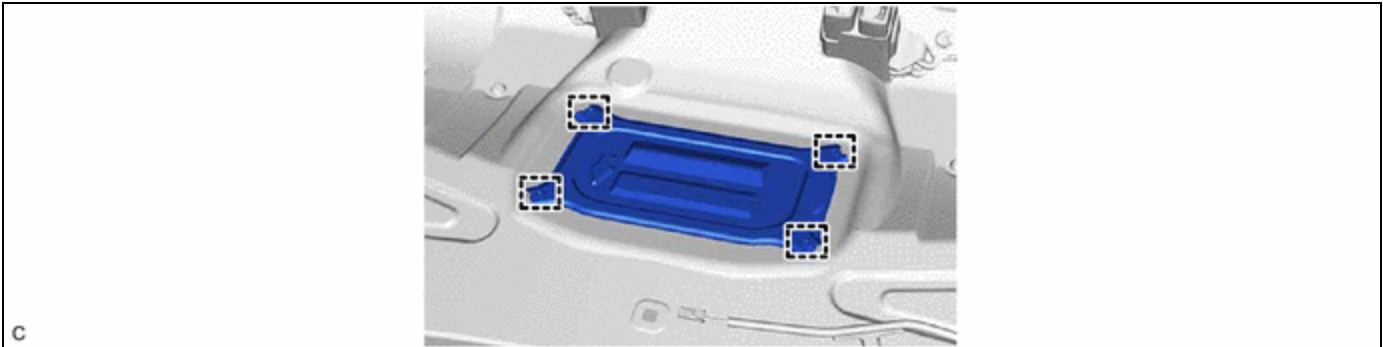

### 9. REMOVE NO. 2 TRACTION BATTERY COVER

	<b>CAUTION:</b> Be sure to wear insulated gloves.
--	--

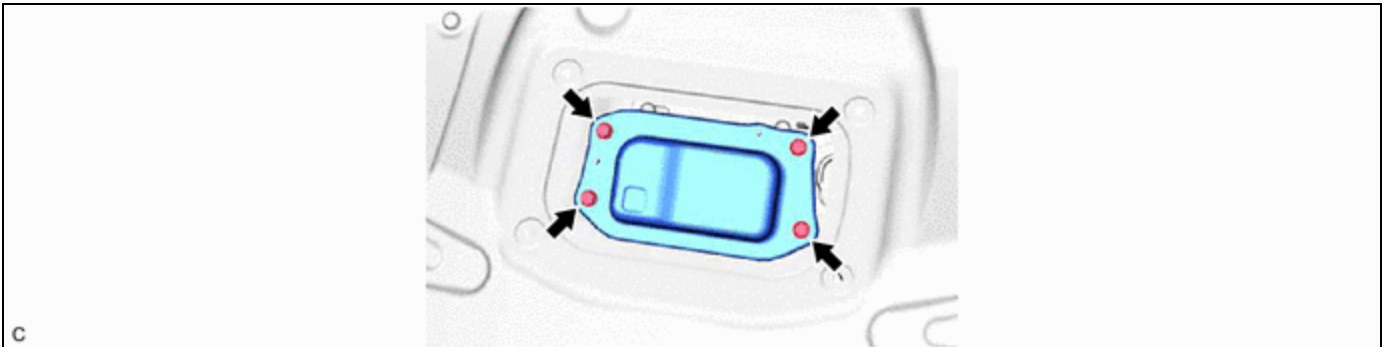

### 10. REMOVE NO. 1 HYBRID BATTERY REAR SHIELD SEAL

	<b>CAUTION:</b> Be sure to wear insulated gloves.
---	--



## 11. REMOVE SERVICE PLUG GRIP



### CAUTION:

- Be sure to wear insulated gloves.
- Do not inspect or service the high voltage system with the service plug grip installed.

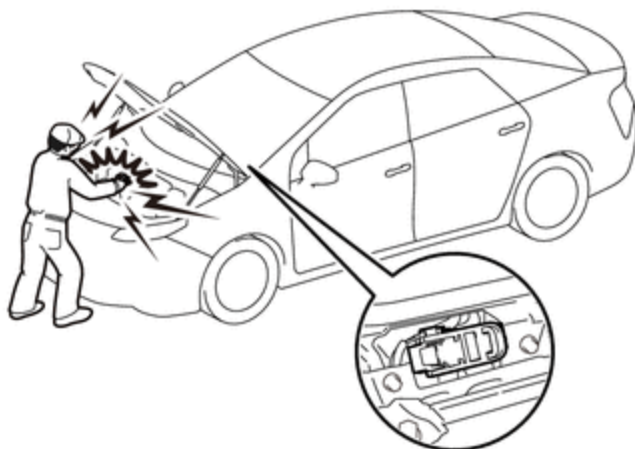

- To reduce the risk of electric shock, make sure to remove the service plug grip to cut off the high voltage circuit before servicing the vehicle.
- To reduce the risk of electric shock, make sure to wait at least 10 minutes after removing the service plug grip to fully discharge the high voltage capacitor inside the inverter with converter





assembly.

- Keep the removed service plug grip in your pocket to prevent other technicians from accidentally installing it while you are servicing the vehicle.



**NOTICE:**

- After removing the service plug grip, turning the ignition switch to ON (READY) may cause a malfunction. Do not turn the ignition switch to ON (READY) unless instructed by the repair manual.
- Do not touch the terminals of the service plug grip.
- If the service plug grip has been struck or dropped, replace it.

**HINT:**

Waiting for at least 10 minutes is required to discharge the high voltage capacitor inside the inverter with converter assembly.



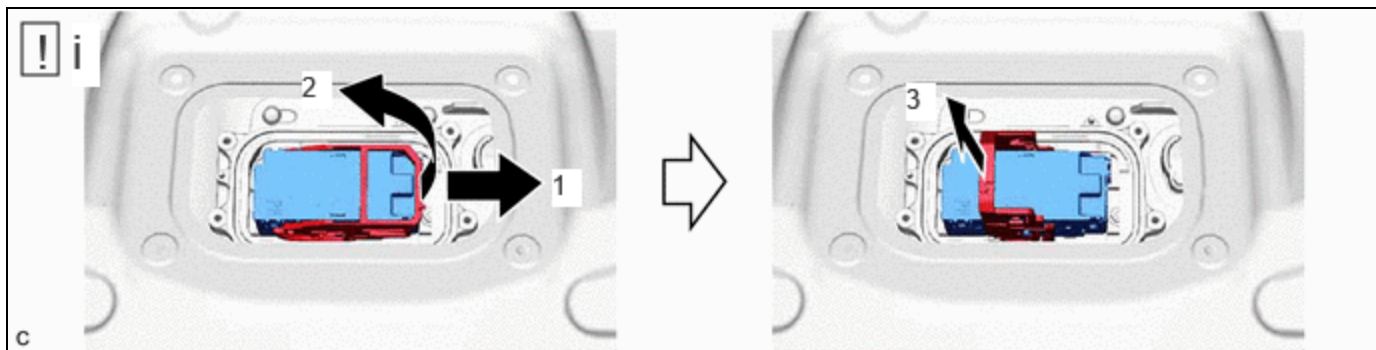

(1) While wearing insulated gloves, rotate the handle of the service plug grip and remove the service plug grip as indicated by the arrows, in the order shown in the illustration.

**CAUTION:**

- Do not allow any foreign matter to fall into the HV supply battery assembly.
- Take steps to prevent foreign material from falling into the HV supply battery assembly after removing the service plug grip.

**12. TEMPORARILY INSTALL NO. 2 TRACTION BATTERY COVER**

