

Last Modified: 12-04-2024	6.11:8.1.0	Doc ID: RM100000028U1A
Model Year Start: 2023	Model: Prius Prime	Prod Date Range: [12/2022 -]
Title: CELLULAR COMMUNICATION: DCM(TELEMATICS TRANSCEIVER): INSTALLATION; 2023 - 2024 MY Prius Prius Prime [12/2022 -]		

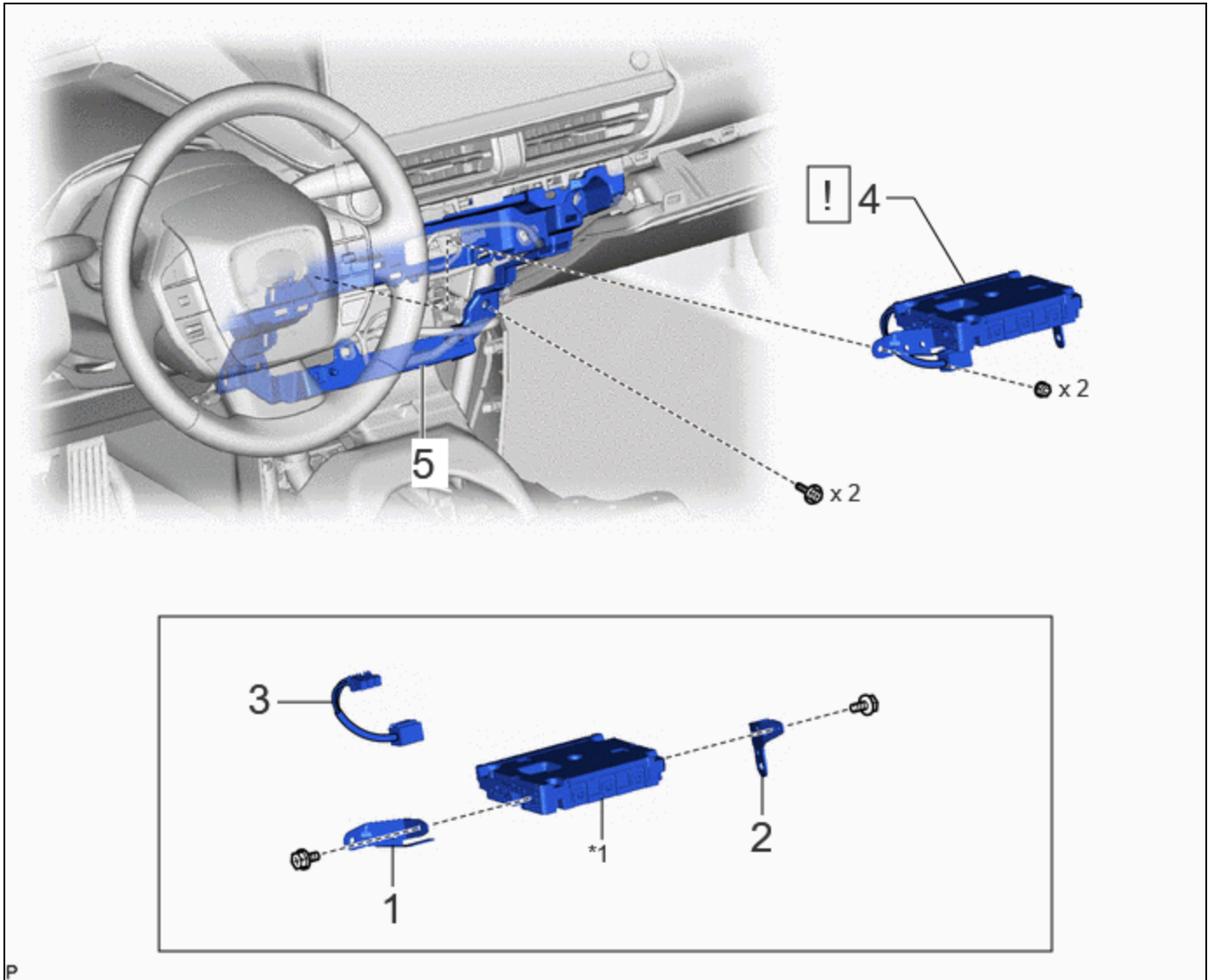

INSTALLATION

CAUTION / NOTICE / HINT

COMPONENTS (INSTALLATION)







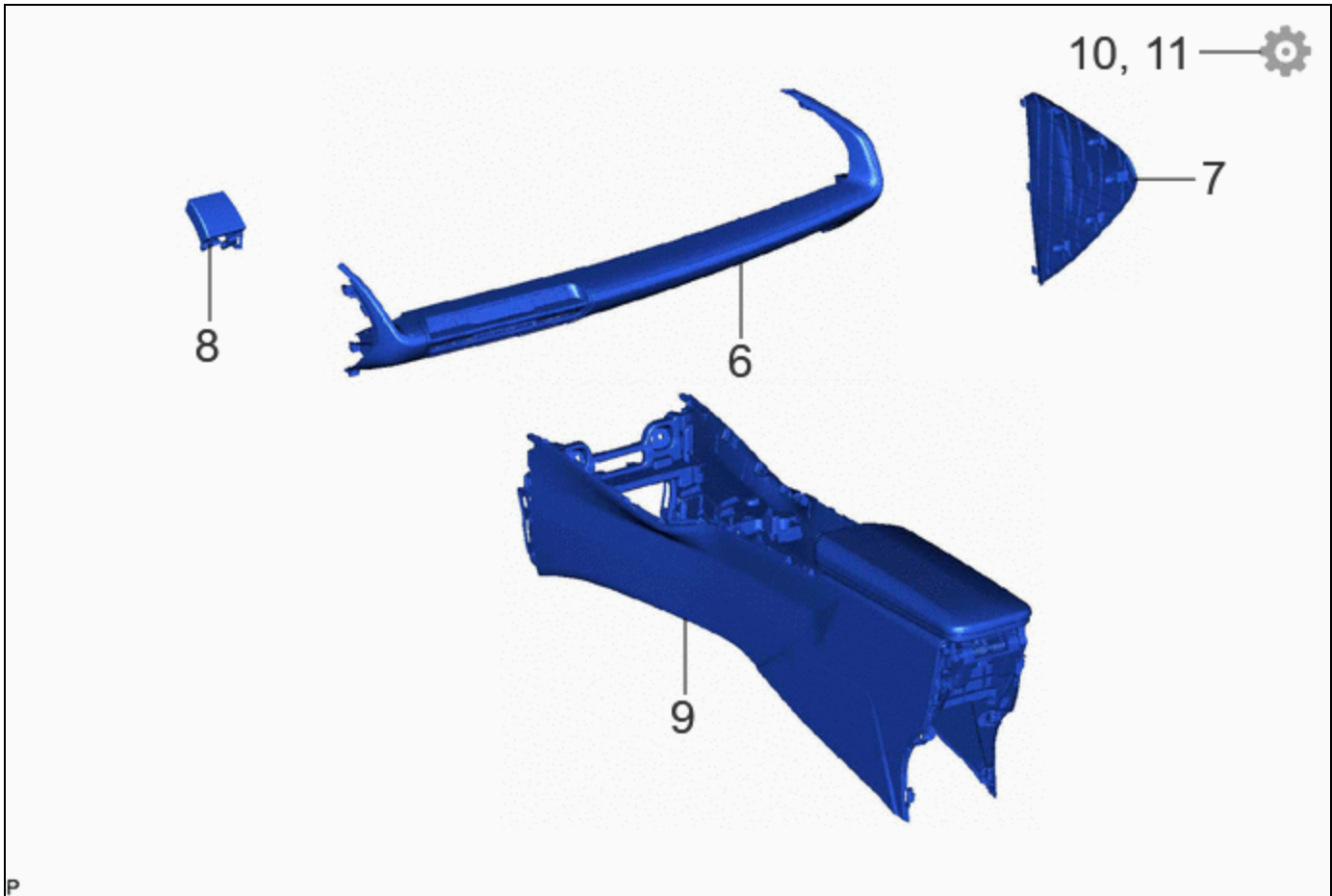

PROCEDURE		PART NAME CODE	!	📄	⚙️
1	NO. 1 TELEPHONE BRACKET	86719A	-	-	-
2	NO. 2 TELEPHONE BRACKET	86719B	-	-	-

	PROCEDURE	PART NAME CODE			
3	ANTENNA CORD SUB-ASSEMBLY	86101S	-	-	-
4	DCM (TELEMATICS TRANSCEIVER) WITH BRACKET	-	INFO	-	-
5	INSTRUMENT PANEL SAFETY PAD SUB-ASSEMBLY	-	-	-	-

*1	DCM (TELEMATICS TRANSCEIVER)	-	-
----	------------------------------	---	---



	PROCEDURE	PART NAME CODE			
6	NO. 2 INSTRUMENT PANEL GARNISH SUB-ASSEMBLY WITH AIR CONDITIONING CONTROL ASSEMBLY	-	-	-	-
7	INSTRUMENT SIDE PANEL LH	55318C	-	-	-
8	LOWER CENTER INSTRUMENT CLUSTER FINISH PANEL SUB-ASSEMBLY	55406B	-	-	-
9	REAR CONSOLE BOX ASSEMBLY	58910C	-	-	-
10	PERFORM DCM ACTIVATION	-	-	-	INFO

PROCEDURE		PART NAME CODE			
11	PERFORM REGISTRATION	-	-	-	

PROCEDURE

1. INSTALL NO. 1 TELEPHONE BRACKET
2. INSTALL NO. 2 TELEPHONE BRACKET
3. INSTALL ANTENNA CORD SUB-ASSEMBLY
4. INSTALL DCM (TELEMATICS TRANSCEIVER) WITH BRACKET

HINT:

The illustration shown is an example only. The illustration may differ from the actual parts according to the model.

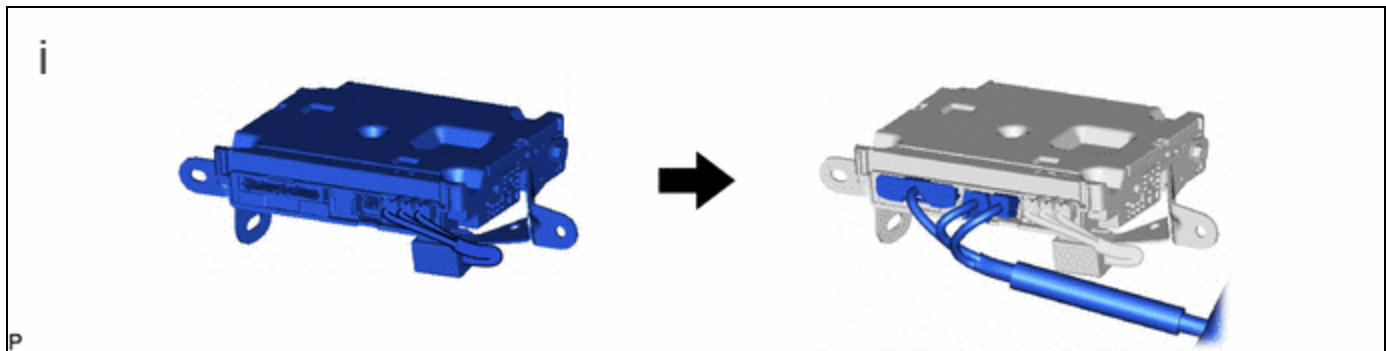

(1) Connect each connector.

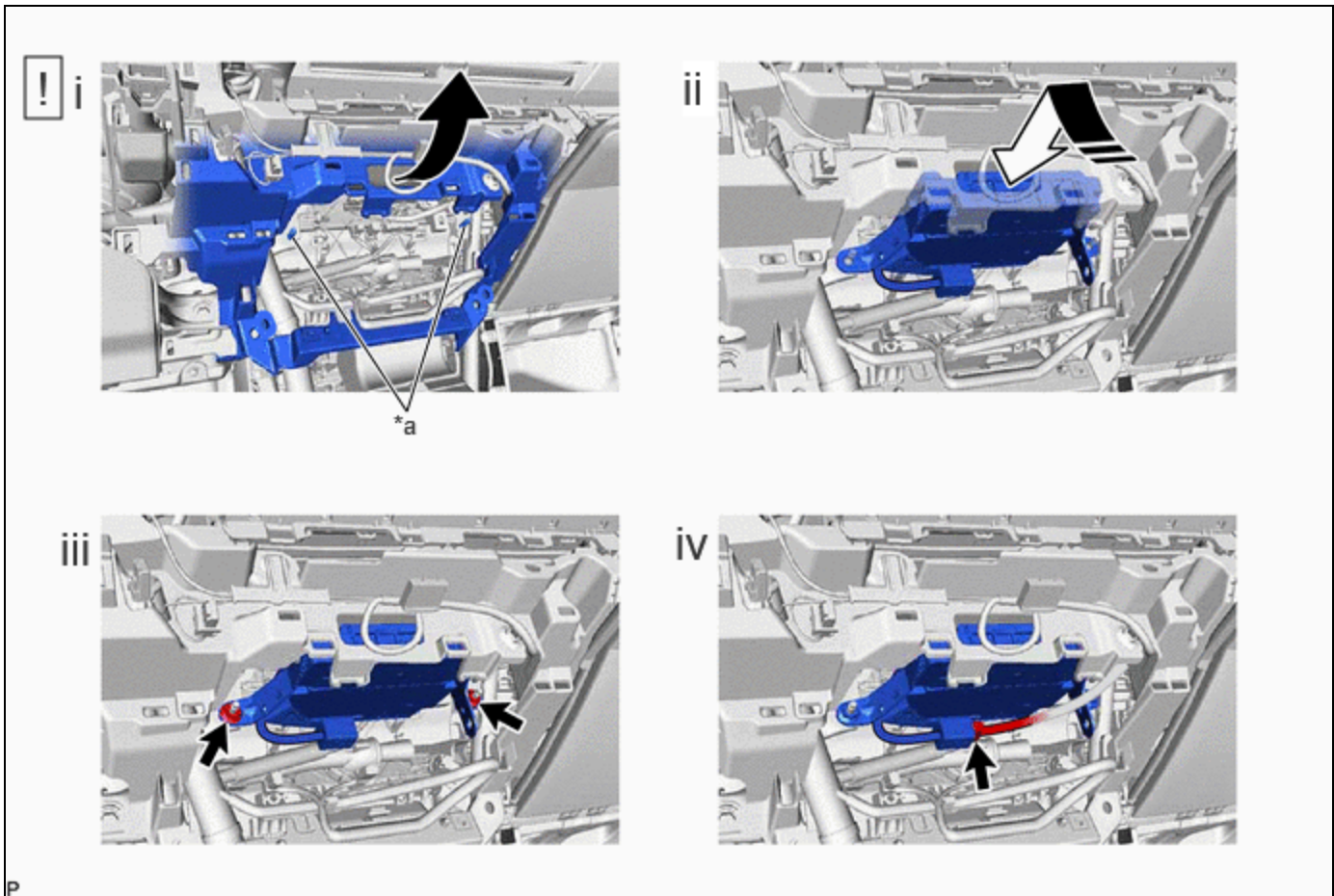

*a	Stud Bolt	-	-
	Install in this Direction	-	-

- (1) As shown in the illustration, pull the instrument panel safety pad sub-assembly a small amount to secure enough space to insert the DCM (telematics transceiver) with bracket over the 2 stud bolts.
- (2) Temporarily install the DCM (telematics transceiver) with bracket as shown in the illustration.
- (3) Install the DCM (telematics transceiver) with bracket with the 2 nuts.
- (4) Connect the connector.

5. CONNECT INSTRUMENT PANEL SAFETY PAD SUB-ASSEMBLY

6. INSTALL NO. 2 INSTRUMENT PANEL GARNISH SUB-ASSEMBLY WITH AIR CONDITIONING CONTROL ASSEMBLY

7. INSTALL INSTRUMENT SIDE PANEL LH

8. INSTALL LOWER CENTER INSTRUMENT CLUSTER FINISH PANEL SUB-ASSEMBLY

9. INSTALL REAR CONSOLE BOX ASSEMBLY

Click here [INFO](#)

10. PERFORM DCM ACTIVATION

HINT:

After replacing the DCM (telematics transceiver), make sure to perform DCM activation.

[Click here](#) 

11. PERFORM REGISTRATION

for Remote Connect Compatible Type:

HINT:

After replacing the DCM (telematics transceiver), make sure to perform code registration (Smart key System (for Start Function)).

[Click here](#) 

