

<b>Last Modified:</b> 12-04-2024	6.11:8.1.0	<b>Doc ID:</b> RM100000002EVXT
<b>Model Year Start:</b> 2024	<b>Model:</b> Prius Prime	<b>Prod Date Range:</b> [09/2023 - ]
<b>Title:</b> INTERIOR PANELS / TRIM: MAT SET PLATE: REMOVAL; 2024 MY Prius Prius Prime [09/2023 - ]		

## REMOVAL

### CAUTION / NOTICE / HINT

#### COMPONENTS (REMOVAL)

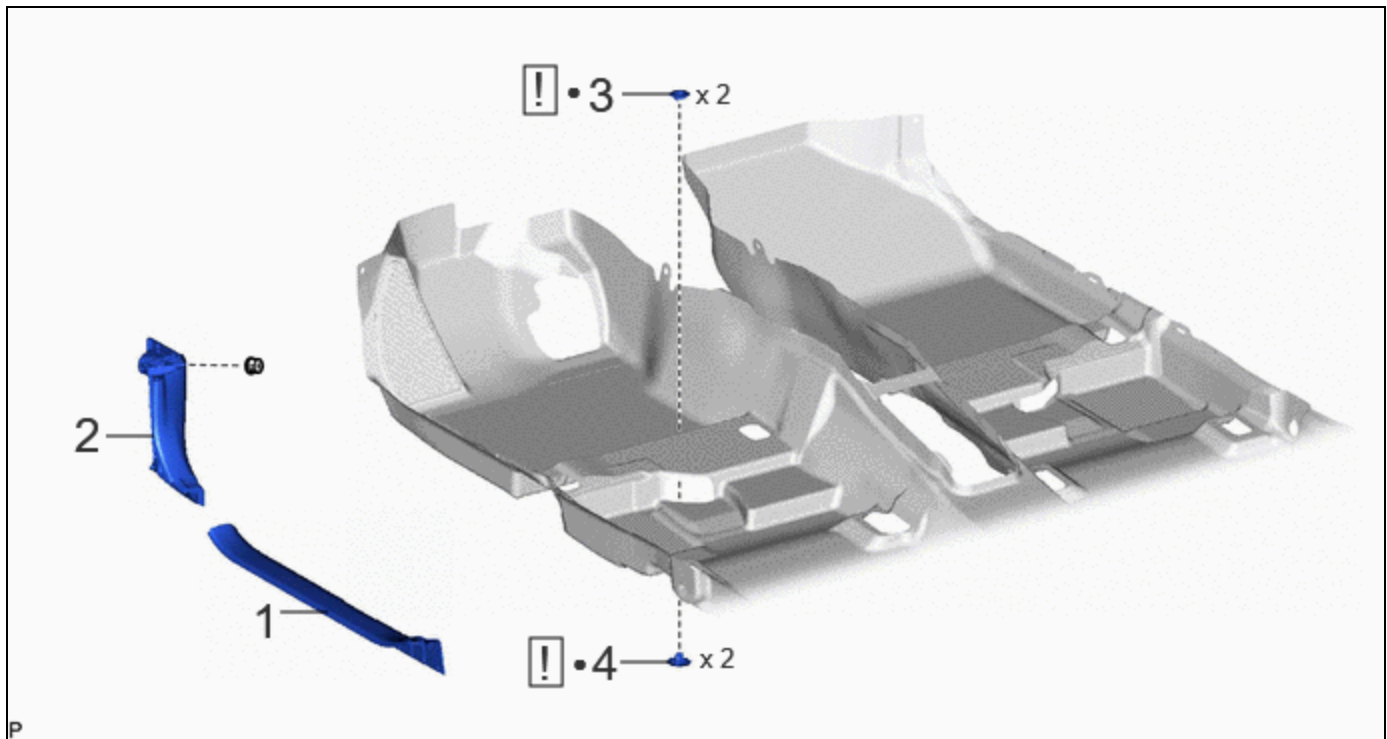

PROCEDURE	PART NAME CODE	!	📄	⚙️
1 FRONT DOOR SCUFF PLATE LH	67914	-	-	-
2 COWL SIDE TRIM BOARD LH	62112	-	-	-
3 MAT SET UPPER PLATE	58694B	<a href="#">INFO</a>	-	-
4 MAT SET LOWER PLATE	58698C	<a href="#">INFO</a>	-	-

• Non-reusable part	-	-
---------------------	---	---

## PROCEDURE

### 1. REMOVE FRONT DOOR SCUFF PLATE LH

Click here [INFO](#)

## 2. REMOVE COWL SIDE TRIM BOARD LH

Click here [INFO](#)

## 3. REMOVE MAT SET UPPER PLATE

	<p><b>NOTICE:</b></p> <ul style="list-style-type: none"> <li>Do not forcefully pull the front floor carpet assembly as it may deform the installation holes of the mat set plate.</li> <li>Do not remove the reinforcements on the back of the mat set plate mounting holes of the front floor carpet assembly.</li> <li>If the mat set plate mounting holes of the front floor carpet assembly are damaged or deformed, replace the front floor carpet assembly.</li> </ul>
---	--

**HINT:**

Remove necessary parts for replacement of floor mat clips.

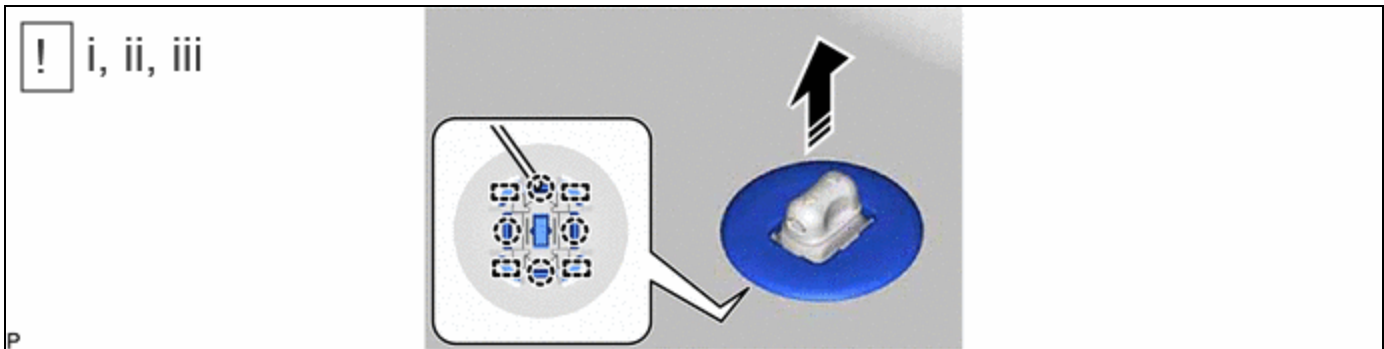



	Remove in this Direction	-	-
---	--------------------------	---	---

- (1) Using a screwdriver, break the 4 claws as shown in the illustration.
- (2) Disengage the 4 guides to remove the mat set upper plate from the mat set lower plate and front floor carpet assembly.
- (3) Use the same procedure for all mat set upper plates.

## 4. REMOVE MAT SET LOWER PLATE

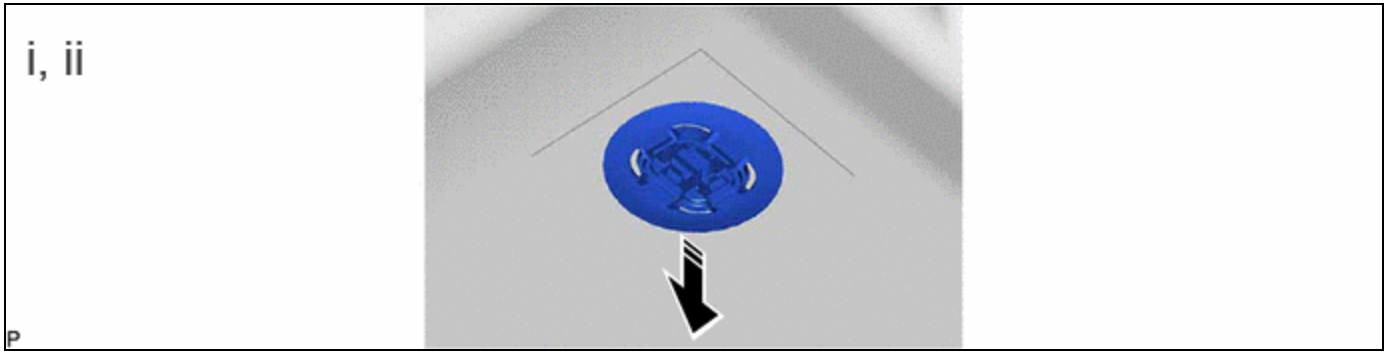
	<p><b>NOTICE:</b></p> <ul style="list-style-type: none"> <li>Do not forcefully pull the front floor carpet assembly as it may deform the installation holes of the mat set plate.</li> <li>Do not remove the reinforcements on the back of the mat set plate mounting holes of the front floor carpet assembly.</li> <li>If the mat set plate mounting holes of the front floor carpet assembly are damaged or deformed, replace the front floor carpet assembly.</li> </ul>
---	--



	Remove in this Direction	-	-
---	--------------------------	---	---

- (1) Remove the mat set lower plate.
- (2) Use the same procedure for all mat set lower plates.

