

<b>Last Modified:</b> 12-04-2024	6.11:8.1.0	<b>Doc ID:</b> RM10000002AXEB
<b>Model Year Start:</b> 2023	<b>Model:</b> Prius Prime	<b>Prod Date Range:</b> [03/2023 - ]
<b>Title:</b> HEATING / AIR CONDITIONING: INTERNAL CONDENSER TEMPERATURE SENSOR: INSTALLATION; 2023 - 2024 MY Prius Prime [03/2023 - ]		

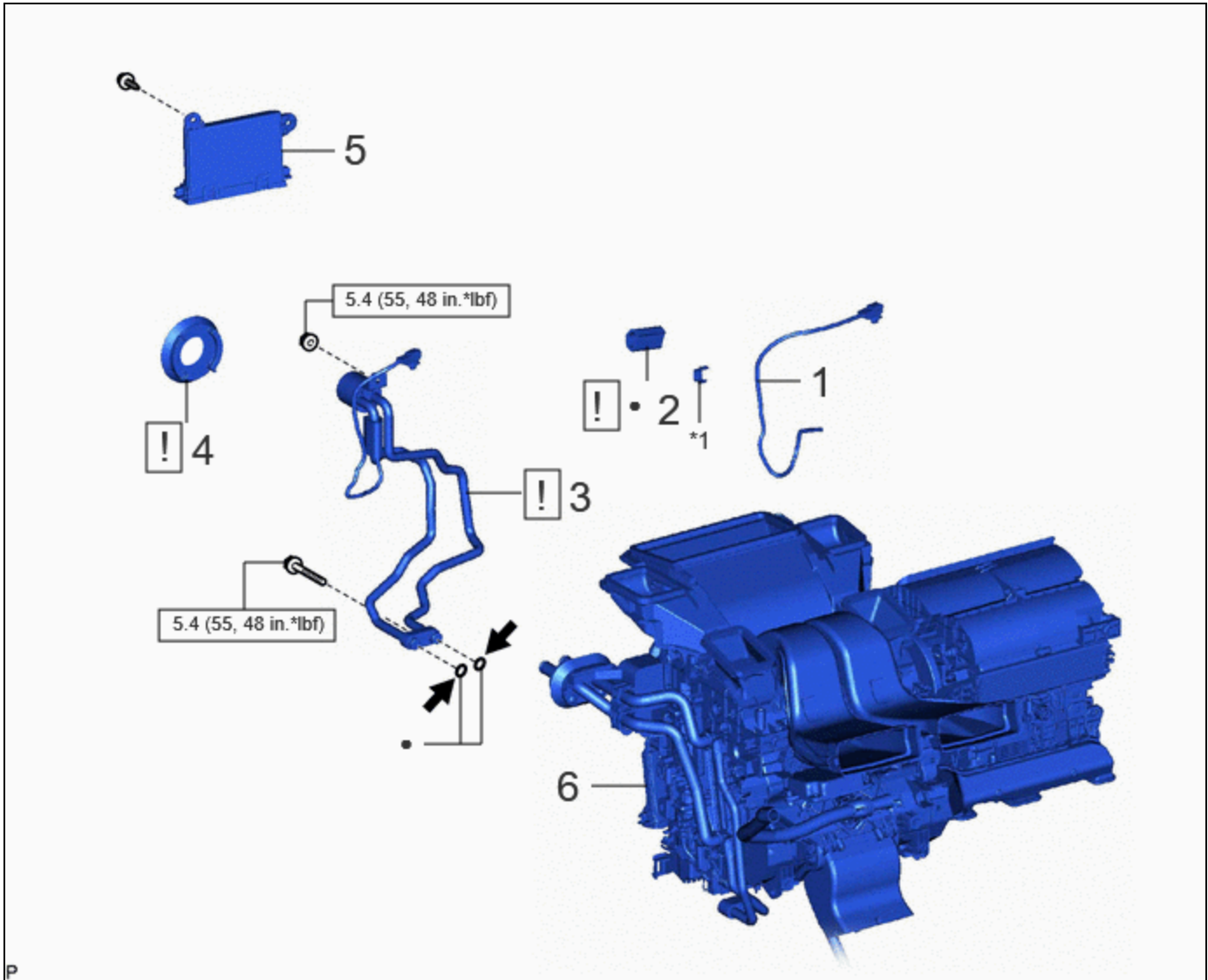

## INSTALLATION



### CAUTION / NOTICE / HINT

#### COMPONENTS (INSTALLATION)



	PROCEDURE	PART NAME CODE	!	📄	⚙️
1	INTERNAL CONDENSER TEMPERATURE SENSOR	88620H	-	-	-
2	NO. 1 COOLING UNIT PACKING	88578B	INFO	-	-

	PROCEDURE	PART NAME CODE			
3	NO. 1 DISCHARGE TUBE	88715M	INFO	-	-
4	COOLING UNIT PARTS	88899L	INFO	-	-
5	AIR CONDITIONING AMPLIFIER ASSEMBLY	88650N	-	-	-
6	AIR CONDITIONER UNIT ASSEMBLY	-	-	-	-

*1	CLAMP	-	-
	N*m (kgf*cm, ft.*lbf): Specified torque		• Non-reusable part
	Compressor oil ND-OIL 11 or equivalent	-	-

## PROCEDURE

### 1. INSTALL INTERNAL CONDENSER TEMPERATURE SENSOR

### 2. INSTALL NO. 1 COOLING UNIT PACKING

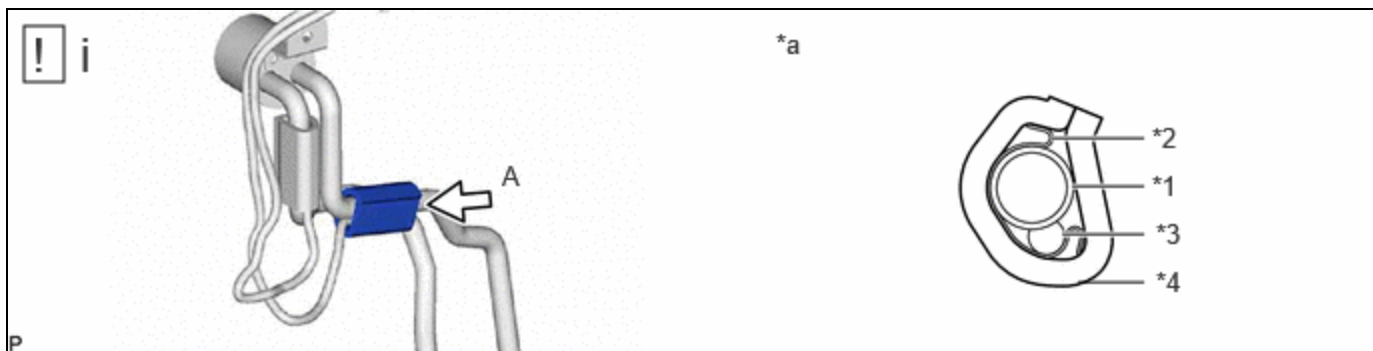

*1	NO. 1 DISCHARGE TUBE	*2	CLAMP
*3	INTERNAL CONDENSER TEMPERATURE SENSOR	*4	NO. 1 COOLING UNIT PACKING
*a	View A	-	-

(1) Perform the following procedure to install the No. 1 cooling unit packing.

1. Remove any remaining No. 1 cooling unit packing from the internal condenser temperature sensor and No. 1 discharge tube.
2. Remove the release paper from a new No. 1 cooling unit packing.
3. Install the No. 1 cooling unit packing as shown in the illustration.

#### NOTICE:

Make sure to install the cooler packing so that its ends are on the opposite side of the internal condenser temperature sensor as shown in the illustration.

### 3. INSTALL NO. 1 DISCHARGE TUBE

	Click here <a href="#">INFO</a>
---	---------------------------------

### 4. INSTALL COOLING UNIT PARTS

	Click here <a href="#">INFO</a>
---	---------------------------------

### 5. INSTALL AIR CONDITIONING AMPLIFIER ASSEMBLY

Click here [INFO](#)

### 6. INSTALL AIR CONDITIONER UNIT ASSEMBLY

Click here [INFO](#)

