

Last Modified: 12-04-2024	6.11:8.1.0	Doc ID: RM100000002AXE6
Model Year Start: 2023	Model: Prius Prime	Prod Date Range: [03/2023 -]
Title: HEATING / AIR CONDITIONING: HEAT PUMP ECU: INSTALLATION; 2023 - 2024 MY Prius Prius Prime [03/2023 -]		

INSTALLATION

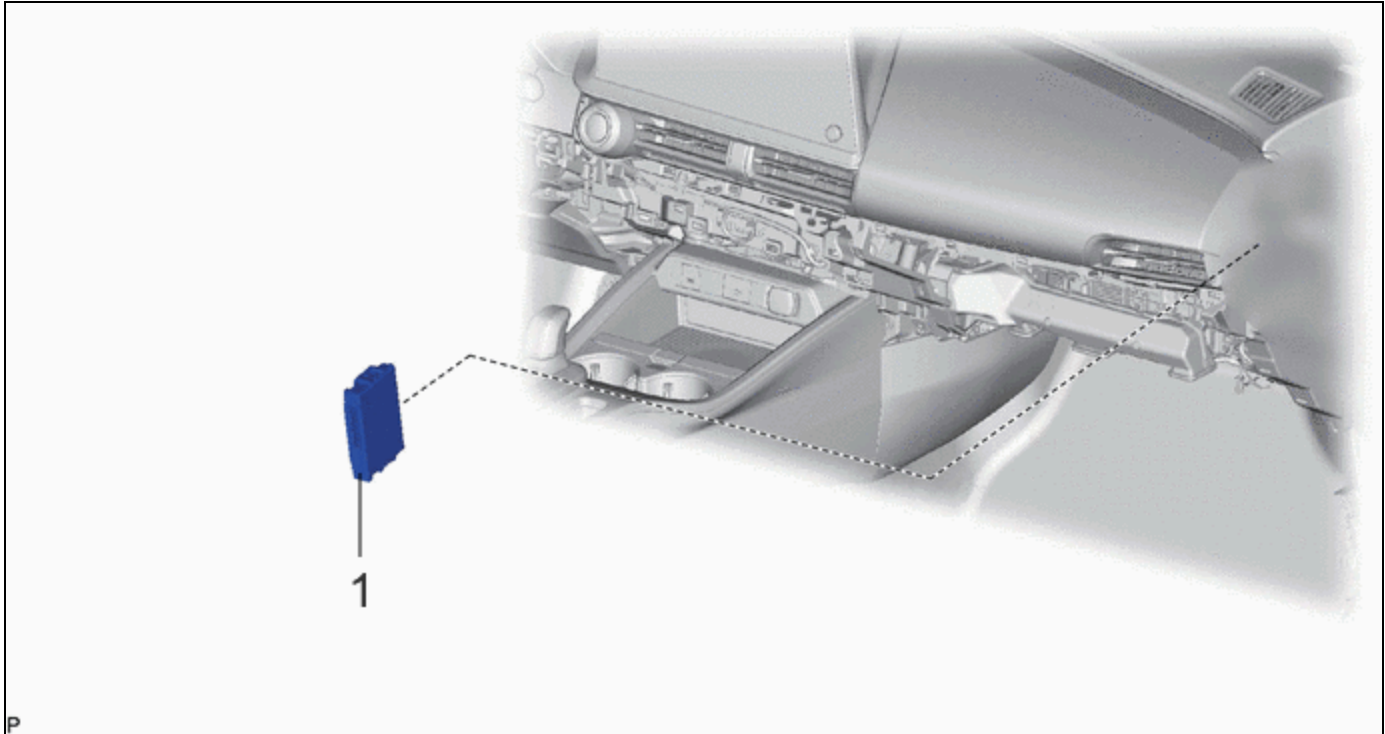

CAUTION / NOTICE / HINT

COMPONENTS (INSTALLATION)

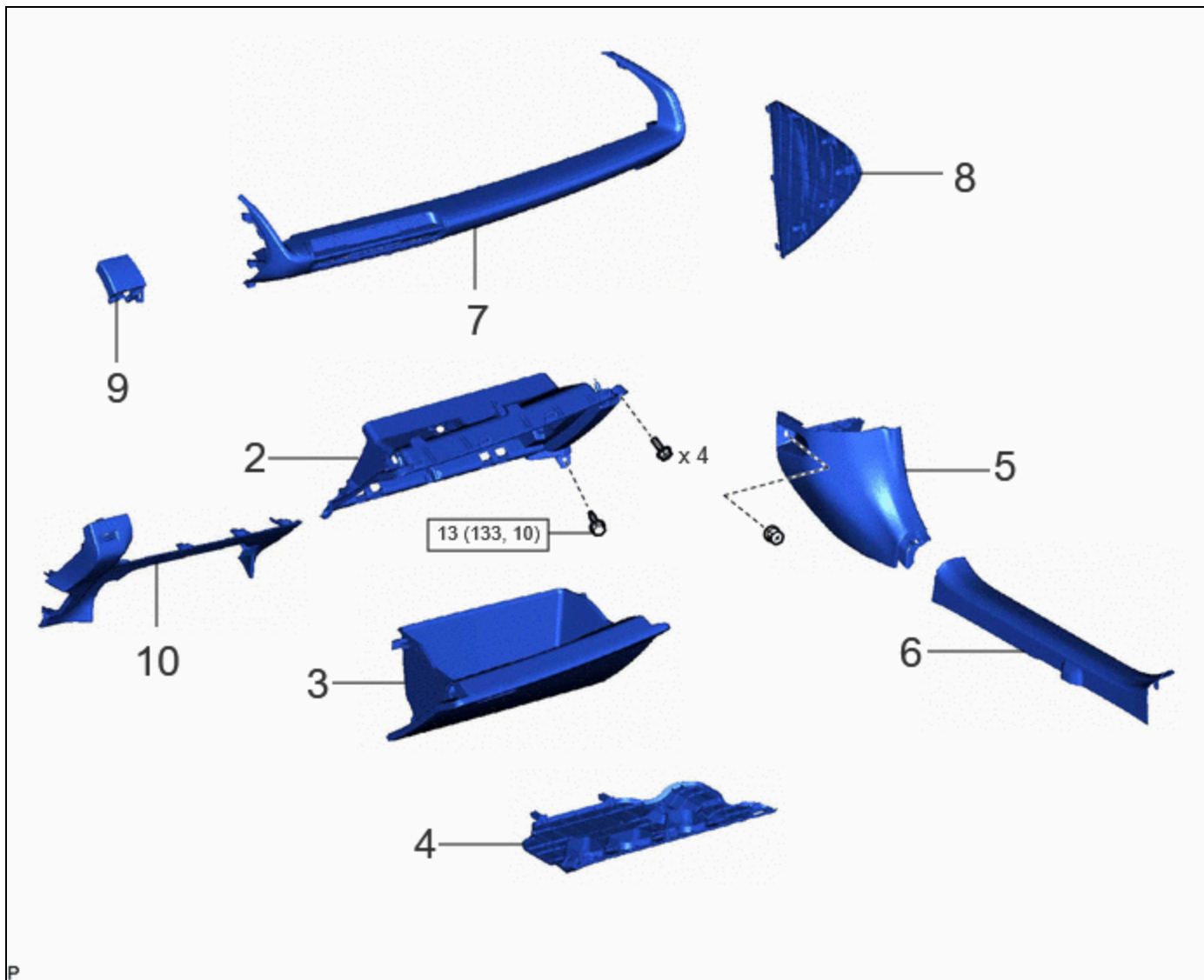

	PROCEDURE	PART NAME CODE			
1	HEAT PUMP ECU ASSEMBLY	886A0	-	-	-



PROCEDURE		PART NAME CODE			
2	LOWER INSTRUMENT PANEL SUB-ASSEMBLY	55303B	-	-	-
3	GLOVE COMPARTMENT DOOR ASSEMBLY	55550	-	-	-
4	NO. 2 INSTRUMENT PANEL UNDER COVER SUB-ASSEMBLY	55607	-	-	-
5	COWL SIDE TRIM BOARD RH	62111C	-	-	-
6	FRONT DOOR SCUFF PLATE RH	67913	-	-	-
7	NO. 2 INSTRUMENT PANEL GARNISH SUB-ASSEMBLY WITH AIR CONDITIONING CONTROL ASSEMBLY	-	-	-	-
8	INSTRUMENT SIDE PANEL RH	55317A	-	-	-
9	LOWER CENTER INSTRUMENT CLUSTER FINISH PANEL SUB-ASSEMBLY	55406B	-	-	-
10	LOWER CENTER INSTRUMENT PANEL FINISH PANEL	55434B	-	-	-

	N*m (kgf*cm, ft.*lbf): Specified torque	-	-
---	---	---	---

PROCEDURE

1. INSTALL HEAT PUMP ECU ASSEMBLY

2. INSTALL LOWER INSTRUMENT PANEL SUB-ASSEMBLY

Click here 

3. INSTALL GLOVE COMPARTMENT DOOR ASSEMBLY

4. INSTALL NO. 2 INSTRUMENT PANEL UNDER COVER SUB-ASSEMBLY

5. INSTALL COWL SIDE TRIM BOARD RH

6. INSTALL FRONT DOOR SCUFF PLATE RH

7. INSTALL NO. 2 INSTRUMENT PANEL GARNISH SUB-ASSEMBLY WITH AIR CONDITIONING CONTROL ASSEMBLY

8. INSTALL INSTRUMENT SIDE PANEL RH

9. INSTALL LOWER CENTER INSTRUMENT CLUSTER FINISH PANEL SUB-ASSEMBLY

10. INSTALL LOWER CENTER INSTRUMENT PANEL FINISH PANEL

