

Last Modified: 12-04-2024	6.11:8.1.0	Doc ID: RM1000000029ZOU
Model Year Start: 2023	Model: Prius Prime	Prod Date Range: [12/2022 -]
Title: SEAT BELT: REAR CENTER SEAT OUTER BELT ASSEMBLY: INSTALLATION; 2023 - 2024 MY Prius Prius Prime [12/2022 -]		

INSTALLATION

CAUTION / NOTICE / HINT



CAUTION:

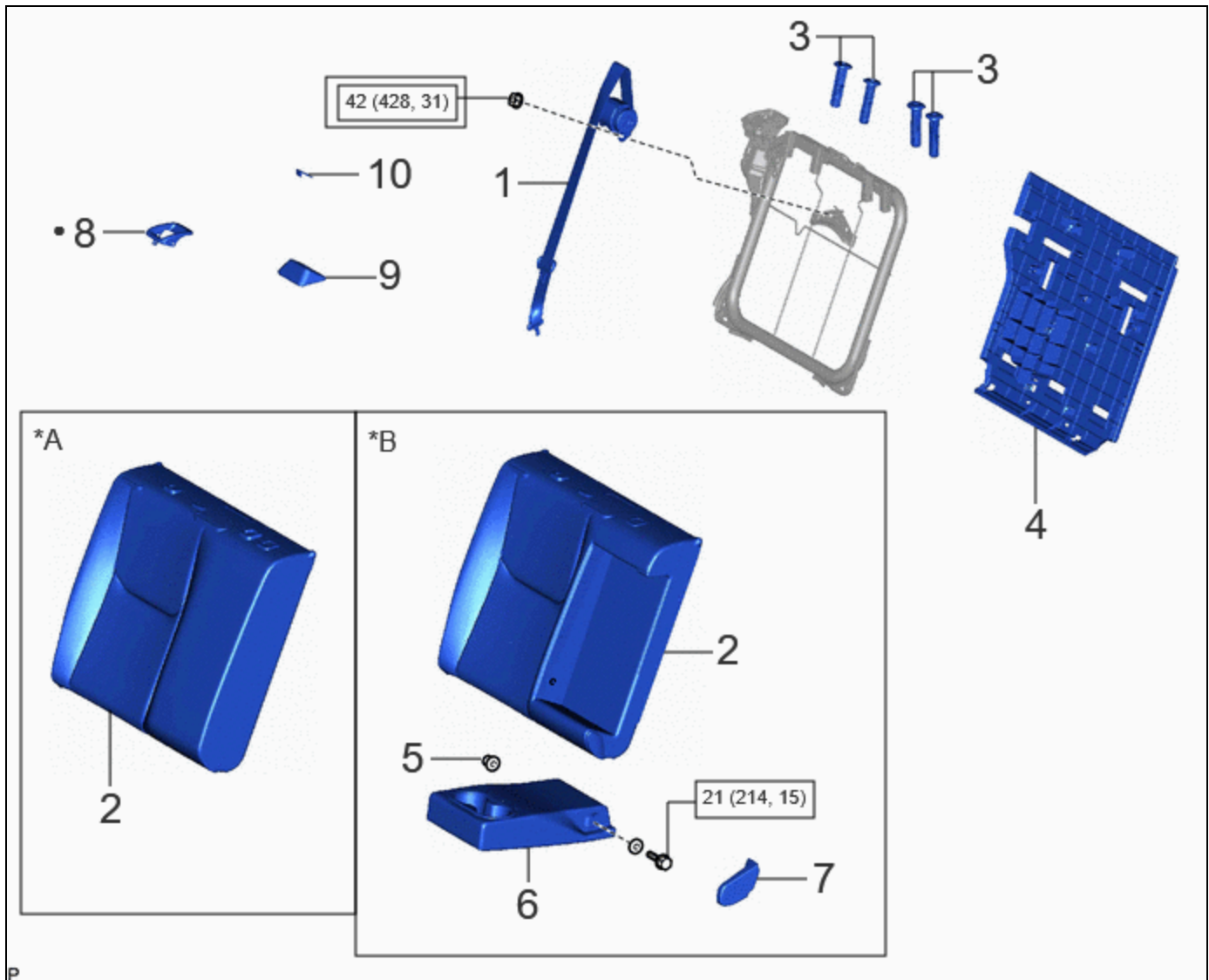

Wear protective gloves. Sharp areas on the parts may injure your hands.

CAUTION / NOTICE / HINT



COMPONENTS (INSTALLATION)



PROCEDURE		PART NAME CODE			
1	REAR CENTER OUTER SEAT BELT ASSEMBLY	73350C	-	-	-
2	SEPARATE TYPE REAR SEATBACK COVER WITH PAD	-	-	-	-
3	REAR SEAT HEADREST SUPPORT	71931A	-	-	-
4	REAR SEATBACK BOARD SUB-ASSEMBLY RH	71701C	-	-	-
5	REAR SEAT ARMREST HINGE SHIM	72839	-	-	-
6	REAR SEAT CENTER ARMREST ASSEMBLY	72830	-	-	-
7	CENTER ARMREST HINGE COVER	72868B	-	-	-
8	REAR SEATBACK UPPER LOCK BEZEL	72667	-	-	-
9	REAR SEAT SHOULDER BELT COVER	73373	-	-	-
10	SEAT BELT ANCHOR COVER CAP	73178A	-	-	-

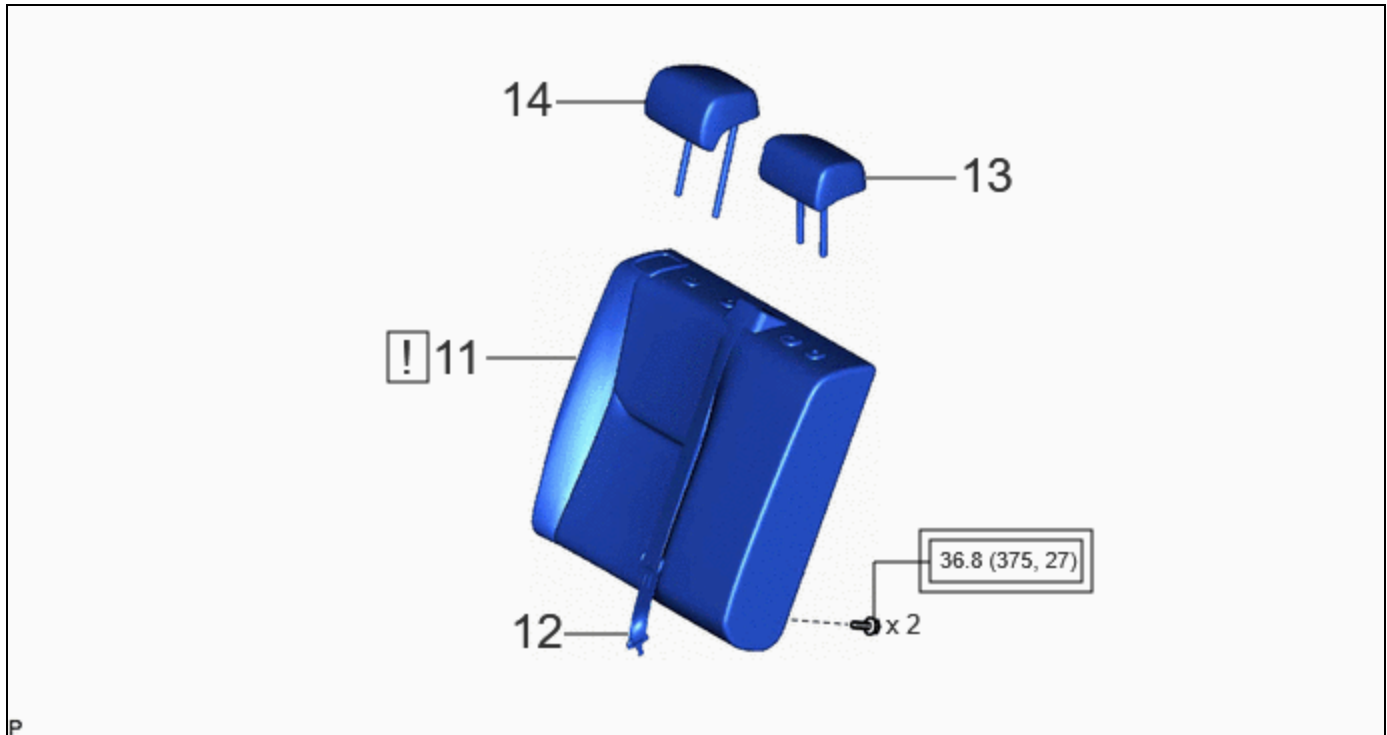

*A	w/o Armrest	*B	w/ Armrest
	Tightening torque for "Major areas involving basic vehicle performance such as moving/turning/stopping": N*m (kgf*cm, ft.*lbf)		N*m (kgf*cm, ft.*lbf): Specified torque
•	Non-reusable part	-	-

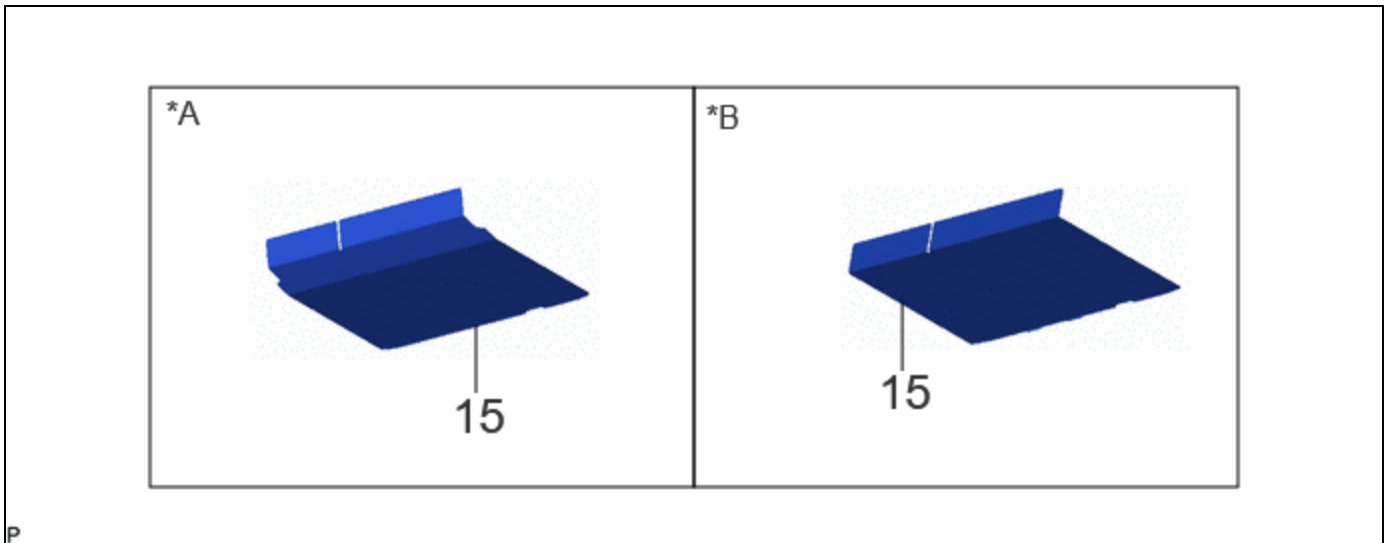

PROCEDURE		PART NAME CODE			
11	REAR SEATBACK ASSEMBLY RH	-	INFO	-	-
12	REAR CENTER SEAT OUTER BELT ASSEMBLY	73350C	-	-	-
13	REAR SEAT CENTER HEADREST ASSEMBLY	71960B	-	-	-
14	REAR SEAT HEADREST ASSEMBLY	71940A	-	-	-

	Tightening torque for "Major areas involving basic vehicle performance such as moving/turning/stopping": N*m (kgf*cm, ft.*lbf)	-	-
---	--	---	---



PROCEDURE		PART NAME CODE			
15	DECK BOARD ASSEMBLY	58410B	-	-	-

*A	for Type A	*B	for Type B
----	------------	----	------------

PROCEDURE

1. INSTALL REAR CENTER SEAT OUTER BELT ASSEMBLY

Torque:

42 N·m {428 kgf·cm, 31 ft·lbf}

2. INSTALL SEPARATE TYPE REAR SEATBACK COVER WITH PAD

3. INSTALL REAR SEAT HEADREST SUPPORT

4. INSTALL REAR SEATBACK BOARD SUB-ASSEMBLY RH

5. INSTALL REAR SEAT ARMREST HINGE SHIM (w/ Armrest)

6. INSTALL REAR SEAT CENTER ARMREST ASSEMBLY (w/ Armrest)

Click here 



7. INSTALL CENTER ARMREST HINGE COVER (w/ Armrest)

8. INSTALL REAR SEATBACK UPPER LOCK BEZEL

9. INSTALL REAR SEAT SHOULDER BELT COVER

10. INSTALL SEAT BELT ANCHOR COVER CAP

11. INSTALL REAR SEATBACK ASSEMBLY RH

	Click here 
---	--

12. CONNECT REAR CENTER SEAT OUTER BELT ASSEMBLY

13. INSTALL REAR SEAT CENTER HEADREST ASSEMBLY

14. INSTALL REAR SEAT HEADREST ASSEMBLY

15. INSTALL DECK BOARD ASSEMBLY

