

Last Modified: 12-04-2024	6.11:8.1.0	Doc ID: RM1000000029TP6
Model Year Start: 2023	Model: Prius Prime	Prod Date Range: [12/2022 -]
Title: SEAT: FRONT SEAT CUSHION HEATER (for Power Seat): INSTALLATION; 2023 - 2024 MY Prius Prius Prime [12/2022 -]		

INSTALLATION

CAUTION / NOTICE / HINT

CAUTION:

Wear protective gloves. Sharp areas on the parts may injure your hands.



CAUTION / NOTICE / HINT

COMPONENTS (INSTALLATION)

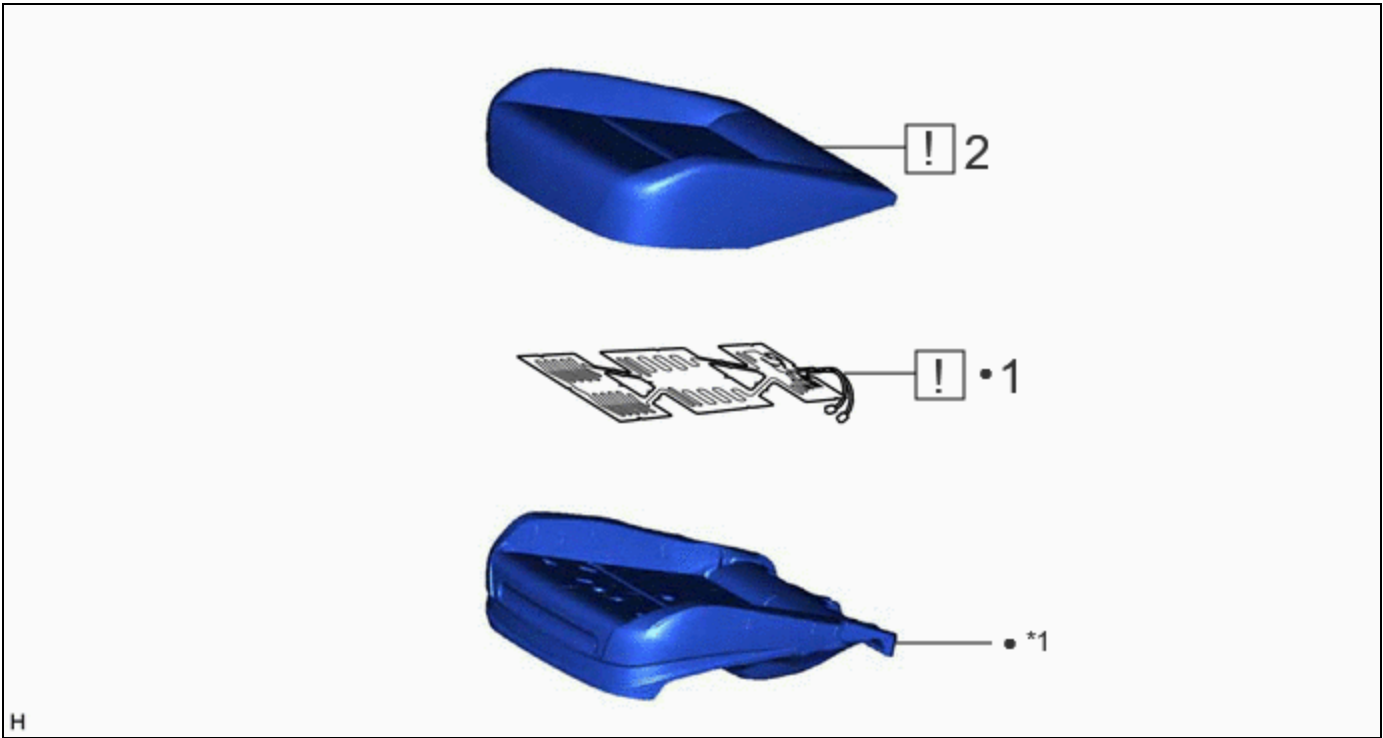



H

	PROCEDURE	PART NAME CODE			
1	FRONT SEAT CUSHION HEATER ASSEMBLY	87510L	INFO	-	-
2	SEPARATE TYPE FRONT SEAT CUSHION COVER	71072S	INFO	-	-

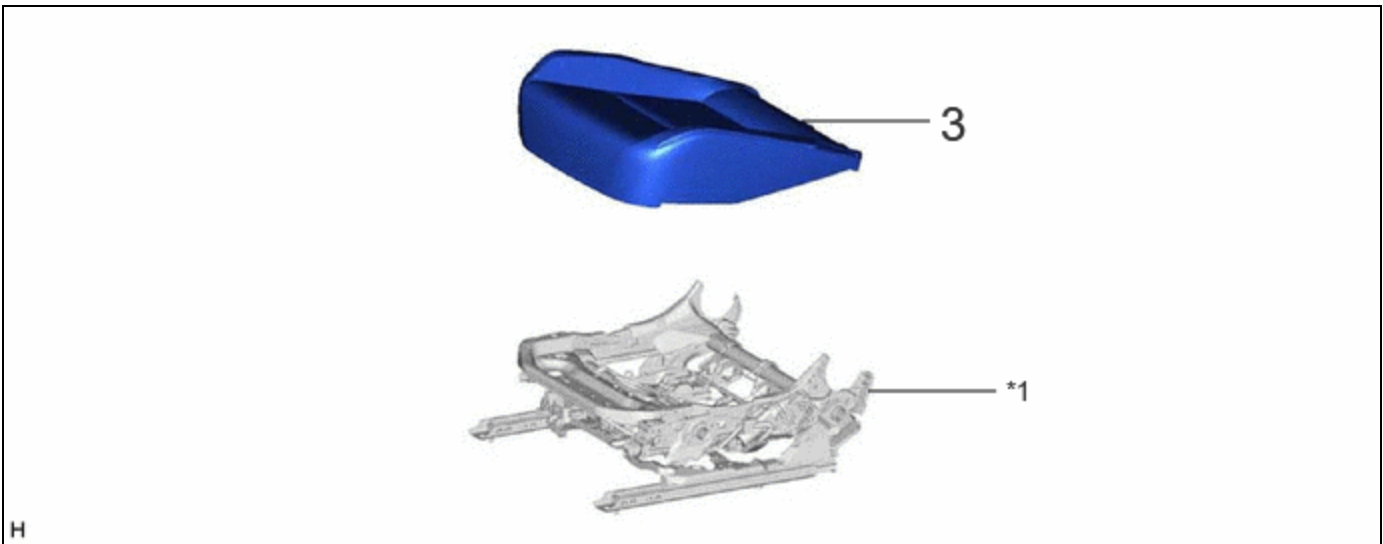
*1	SEPARATE TYPE FRONT SEAT CUSHION PAD	-	-
•	Non-reusable part	-	-





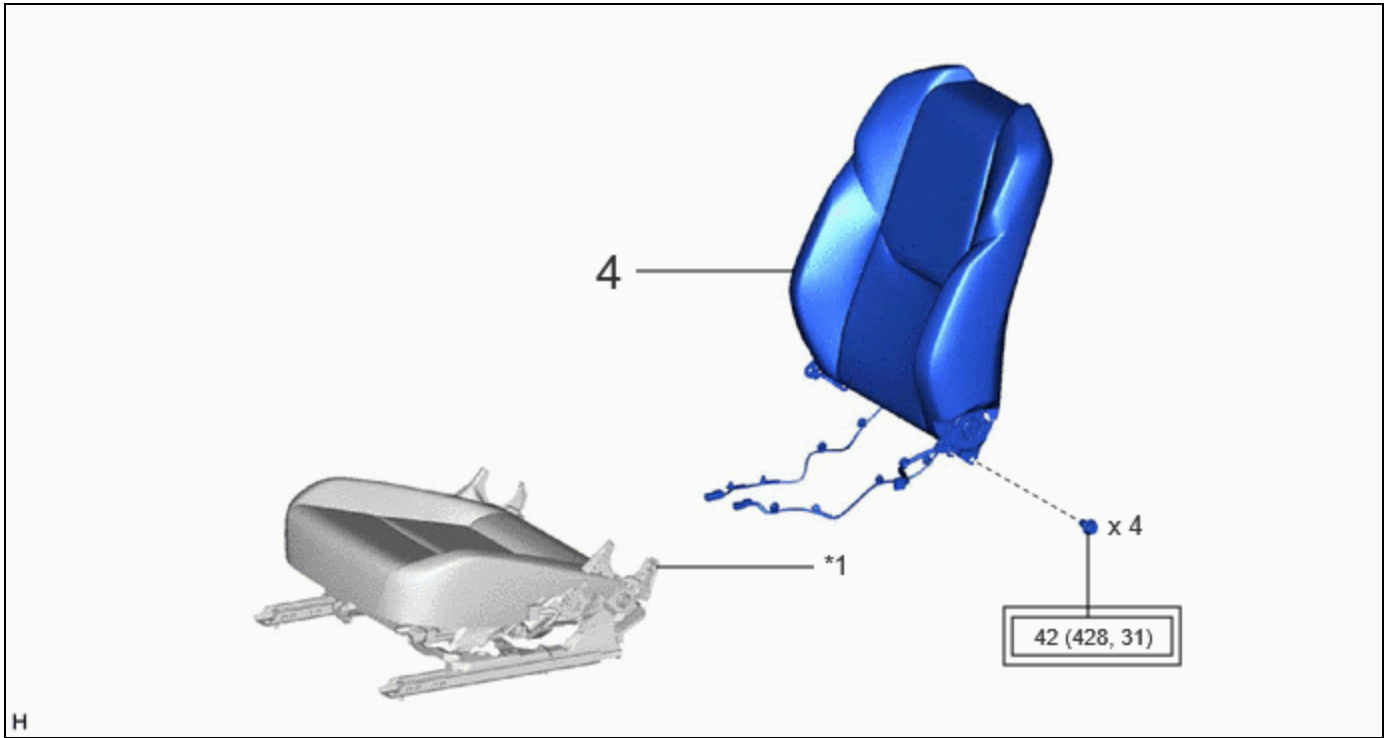

H

PROCEDURE	PART NAME CODE			
3 SEPARATE TYPE FRONT SEAT CUSHION COVER WITH PAD	-	-	-	-

*1 SEPARATE TYPE FRONT SEAT CUSHION SPRING ASSEMBLY	-	-
---	---	---



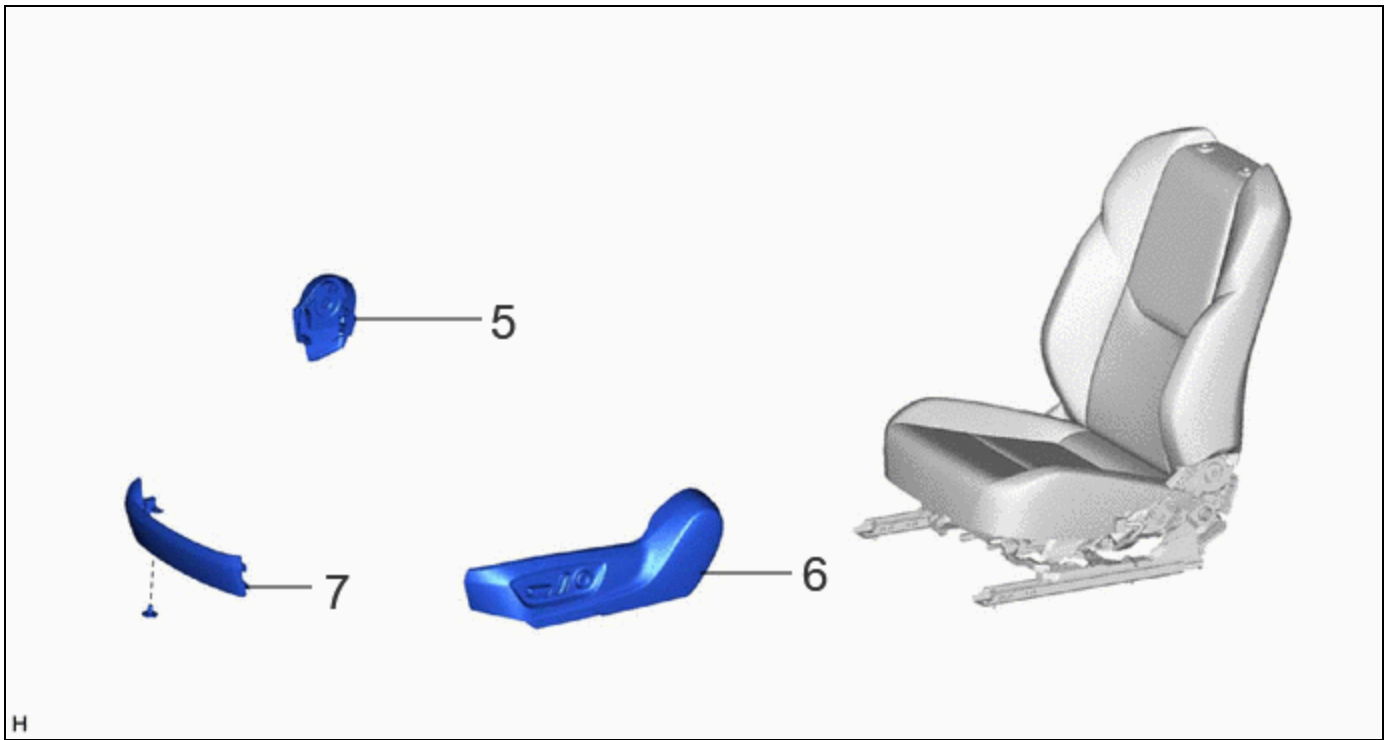

PROCEDURE	PART NAME CODE			
4 SEPARATE TYPE FRONT SEATBACK ASSEMBLY	-	-	-	-

*1	SEPARATE TYPE FRONT SEAT CUSHION ASSEMBLY	-	-
	Tightening torque for "Major areas involving basic vehicle performance such as moving/turning/stopping": N*m (kgf*cm, ft.*lbf)	-	-







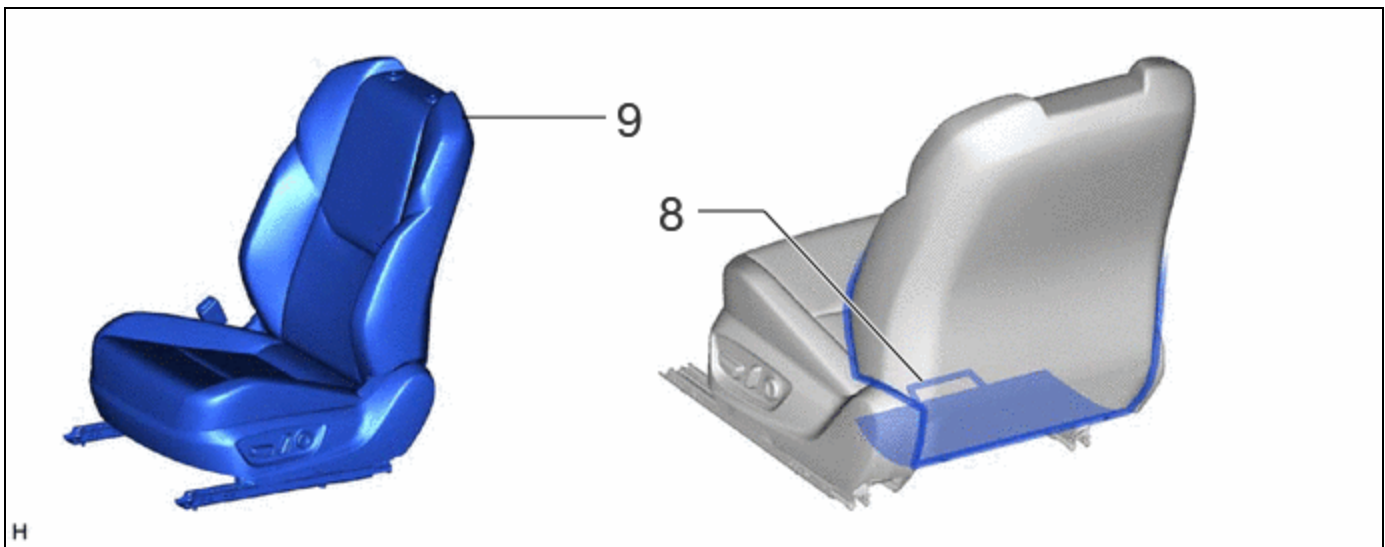

H

PROCEDURE		PART NAME CODE			
5	FRONT SEAT INNER CUSHION SHIELD	71862	-	-	-
6	FRONT SEAT CUSHION SHIELD	71812D	-	-	-
7	FRONT SEAT FRONT CUSHION SHIELD	71868N	-	-	-



H

PROCEDURE		PART NAME CODE			
8	CONNECT SEPARATE TYPE FRONT SEATBACK COVER	71074S	-	-	-

PROCEDURE		PART NAME CODE			
9	FRONT SEAT ASSEMBLY	-	-	-	-

PROCEDURE

1. INSTALL FRONT SEAT CUSHION HEATER ASSEMBLY

	<p>NOTICE:</p> <p>Replace the front seat cushion heater assembly and separate type front seat cushion pad as a set.</p>
---	--

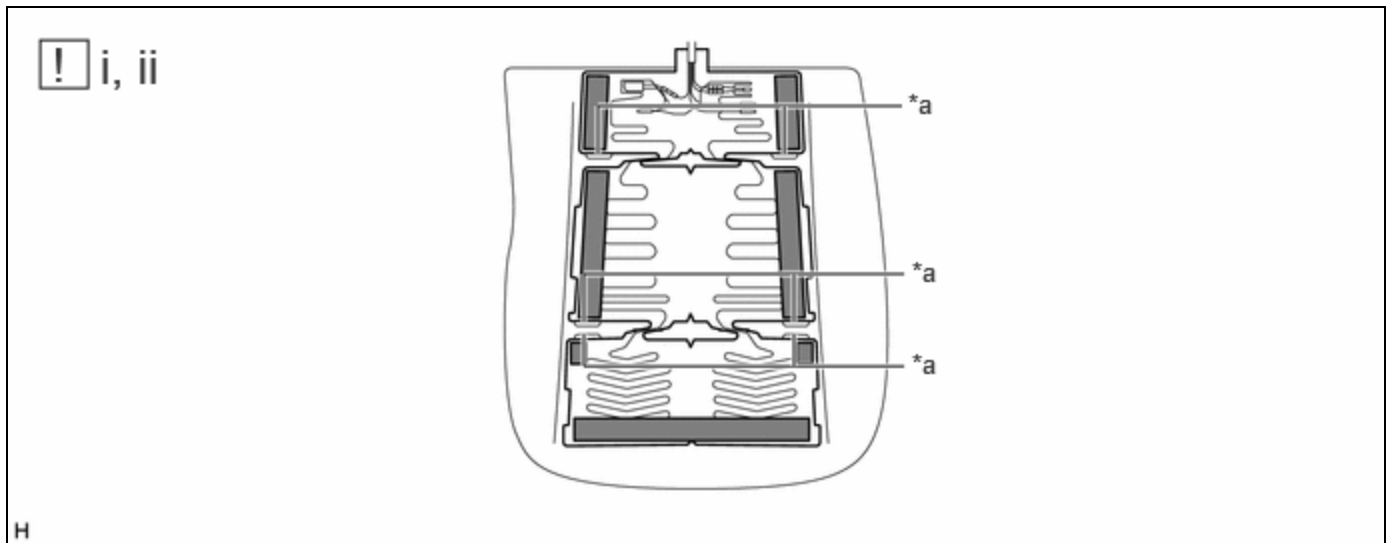

*a	Cutout	-	-
	Double-sided Tape	-	-

- (1) Remove the release paper from a new front seat cushion heater assembly.
- (2) Install the new front seat cushion heater assembly while aligning with the cutouts as shown in the illustration.

NOTICE:

Press the front seat cushion heater assembly firmly to install it.

2. INSTALL SEPARATE TYPE FRONT SEAT CUSHION COVER

	<p>Click here INFO</p>
---	--

3. INSTALL SEPARATE TYPE FRONT SEAT CUSHION COVER WITH PAD

4. INSTALL SEPARATE TYPE FRONT SEATBACK ASSEMBLY

Click here 

5. INSTALL FRONT SEAT INNER CUSHION SHIELD

6. INSTALL FRONT SEAT CUSHION SHIELD

7. INSTALL FRONT SEAT FRONT CUSHION SHIELD

8. CONNECT SEPARATE TYPE FRONT SEATBACK COVER

9. INSTALL FRONT SEAT ASSEMBLY

Click here 

