

Last Modified: 12-04-2024	6.11:8.1.0	Doc ID: RM10000002AMRO
Model Year Start: 2023	Model: Prius Prime	Prod Date Range: [03/2023 -]
Title: M20A-FXS (ENGINE MECHANICAL): ENGINE ASSEMBLY (for PHEV Model): INSTALLATION; 2023 - 2024 MY Prius Prime [03/2023 -]		

INSTALLATION

CAUTION / NOTICE / HINT

CAUTION:



- The engine assembly with transaxle is very heavy. Be sure to follow the procedure described in the repair manual, or the engine lifter may suddenly drop or the engine assembly with transaxle may fall off the engine lifter.
- To prevent burns, do not touch the engine, exhaust manifold or other high temperature components while the engine is hot.

CAUTION / NOTICE / HINT

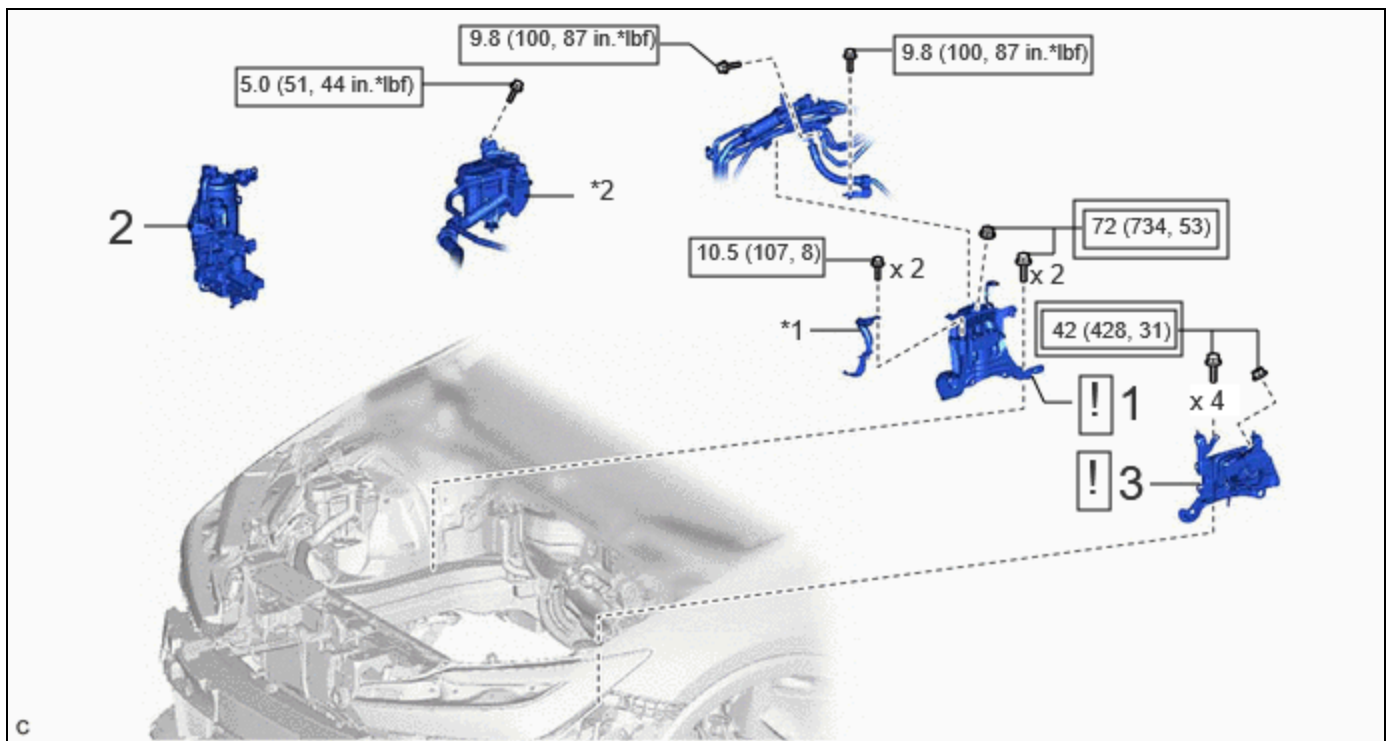

COMPONENTS (INSTALLATION)





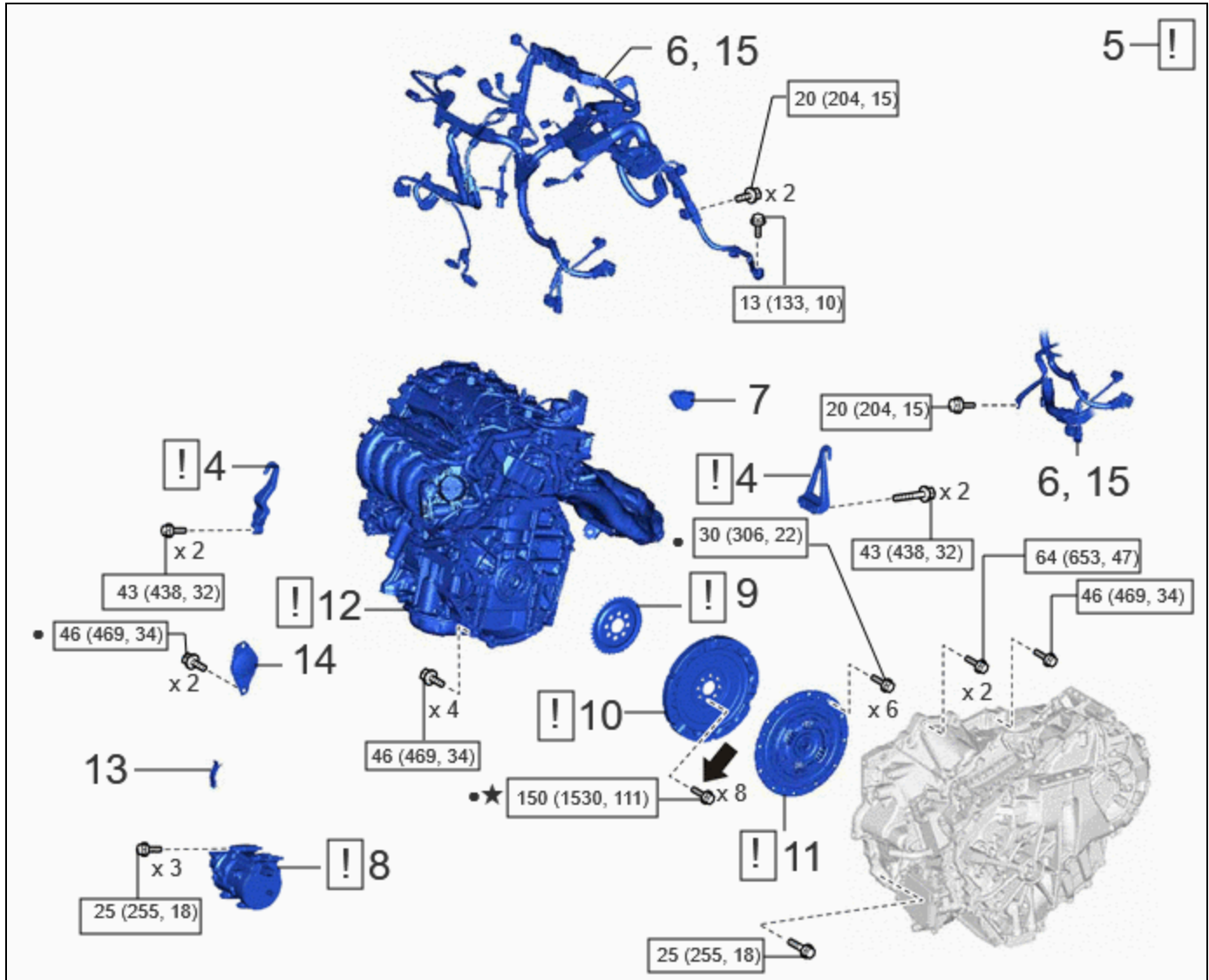





	PROCEDURE	PART NAME CODE			
1	ENGINE MOUNTING INSULATOR SUB-ASSEMBLY RH	12305	INFO	-	-
2	ACCUMULATOR ASSEMBLY	88470H	-	-	-
3	ENGINE MOUNTING INSULATOR LH	12372A	INFO	-	-

*1	NO. 2 EARTH WIRE	*2	RADIATOR RESERVE TANK ASSEMBLY
	Tightening torque for "Major areas involving basic vehicle performance such as moving/turning/stopping": N*m (kgf*cm, ft.*lbf)		N*m (kgf*cm, ft.*lbf): Specified torque



PROCEDURE		PART NAME CODE			
4	INSTALL ENGINE HANGERS	-	INFO	-	-
5	REMOVE ENGINE ASSEMBLY FROM ENGINE STAND	-	INFO	-	-
6	INSTALL ENGINE WIRE	82121	-	-	-
7	FLYWHEEL HOUSING UNDER COVER	11361J	-	-	-
8	COMPRESSOR WITH MOTOR ASSEMBLY	88370	INFO	-	-
9	NO. 1 CRANKSHAFT POSITION SENSOR PLATE	19315	INFO	-	-

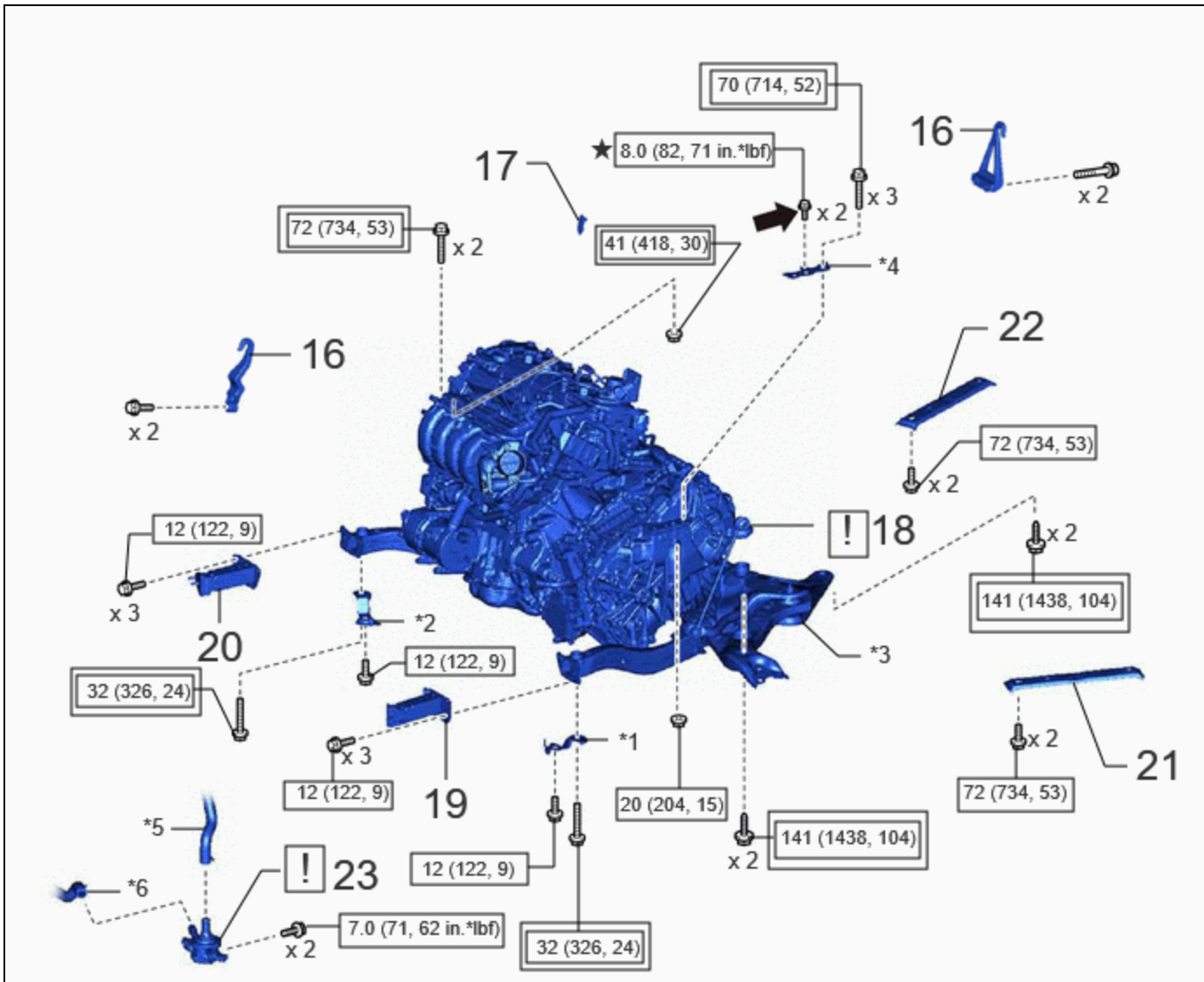

PROCEDURE		PART NAME CODE			
10	FLYWHEEL SUB-ASSEMBLY	13405		-	-
11	TRANSMISSION INPUT DAMPER ASSEMBLY	31270		-	-
12	ENGINE ASSEMBLY	-		-	-
13	FLYWHEEL HOUSING SIDE COVER	11363A	-	-	-
14	STARTER HOLE INSULATOR	28193	-	-	-
15	CONNECT ENGINE WIRE	82121	-	-	-

	N*m (kgf*cm, ft.*lbf): Specified torque	•	Non-reusable part
	Adhesive 1324	★	Precoated part





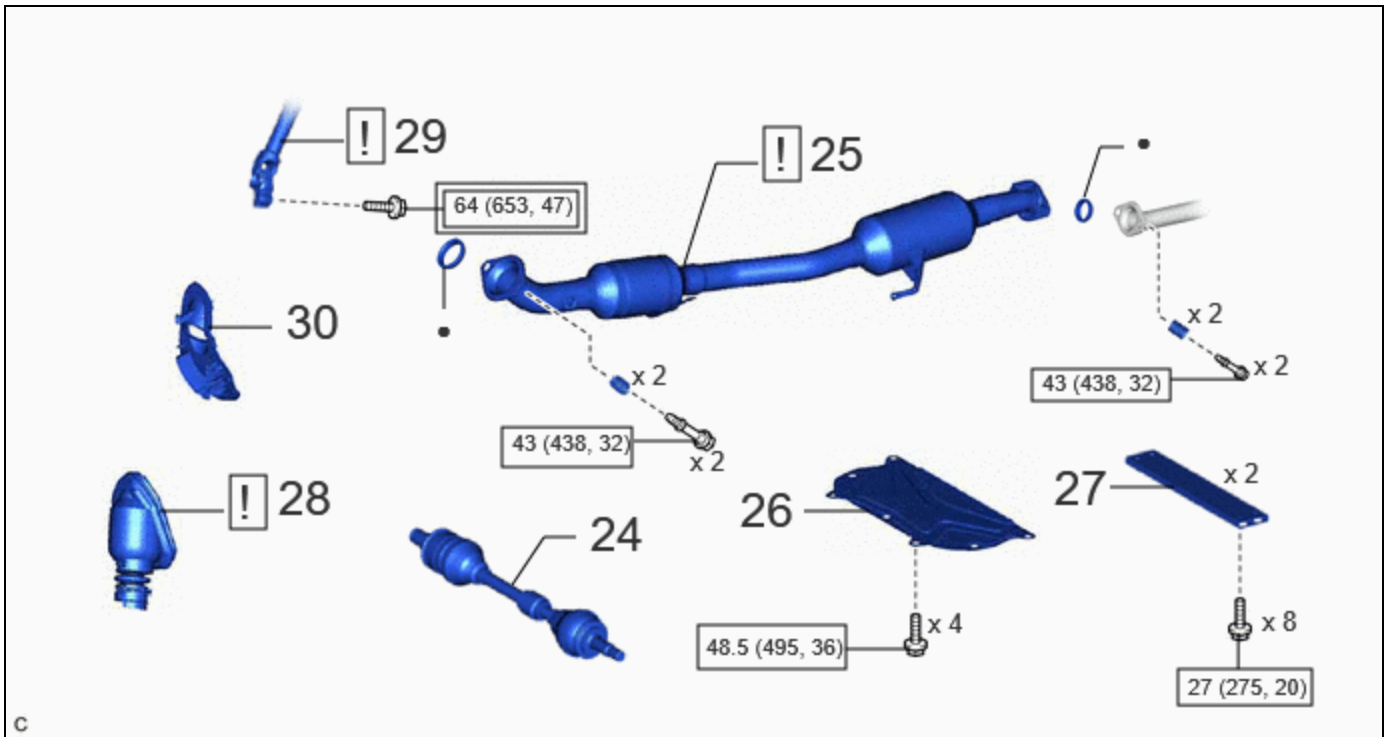

PROCEDURE		PART NAME CODE			
16	REMOVE ENGINE HANGERS	-	-	-	-
17	ENGINE MOUNTING BRACKET CAP	12353	-	-	-
18	ENGINE ASSEMBLY WITH TRANSAXLE	-	INFO	-	-
19	FRONT BUMPER EXTENSION SUB-ASSEMBLY LH	52103A	-	-	-
20	FRONT BUMPER EXTENSION SUB-ASSEMBLY RH	52102B	-	-	-
21	NO. 2 CROSSMEMBER GUSSET LH	51322	-	-	-
22	NO. 2 CROSSMEMBER GUSSET RH	51321	-	-	-
23	INVERTER WATER PUMP WITH MOTOR ASSEMBLY	G9040	INFO	-	-

*1	CENTER RADIATOR SUPPORT LH	*2	CENTER RADIATOR SUPPORT RH
----	----------------------------	----	----------------------------







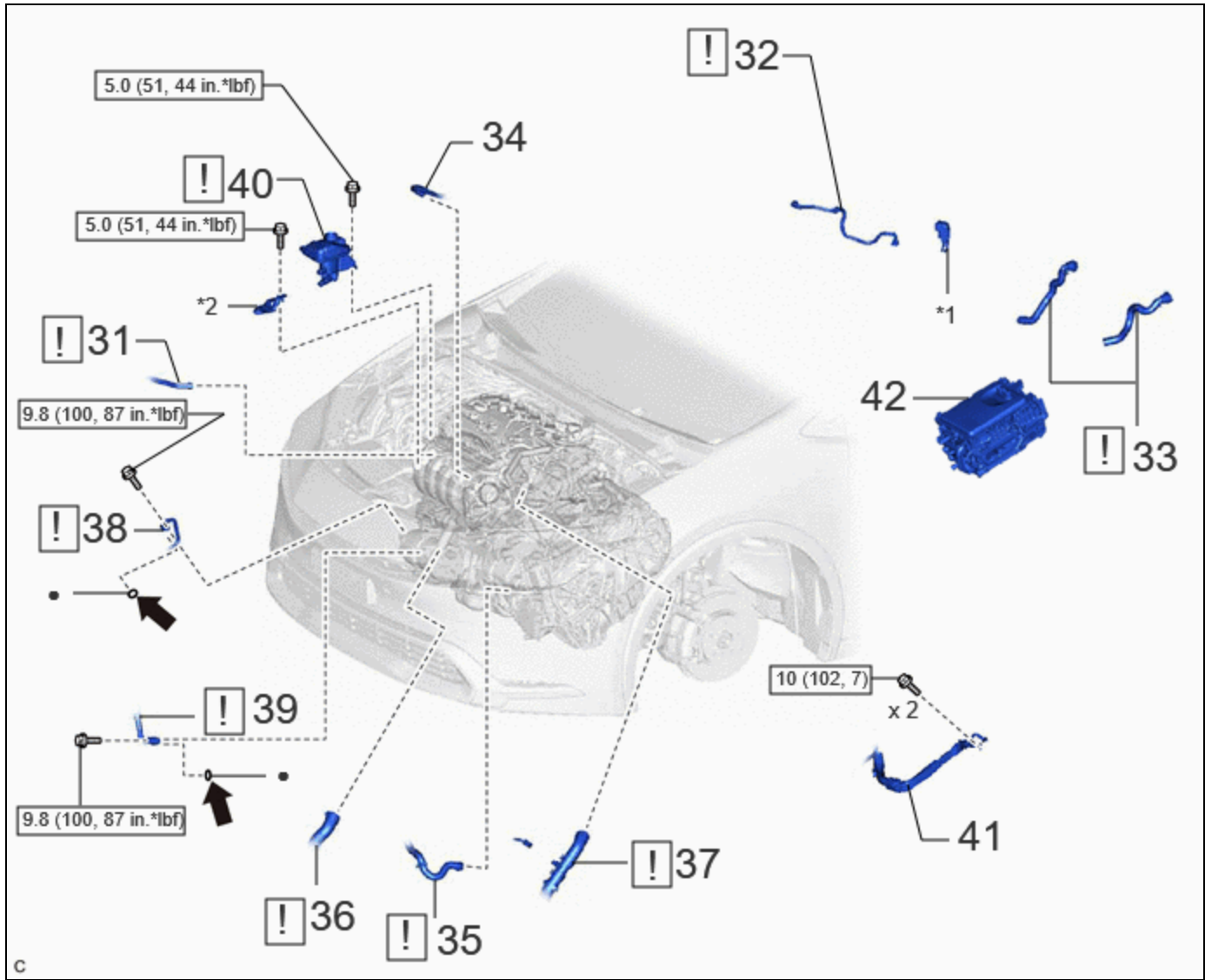

*3	FRONT SUSPENSION CROSSMEMBER SUB-ASSEMBLY	*4	NO. 2 ENGINE MOUNTING STAY LH
*5	HYBRID WATER PUMP INLET HOSE	*6	HYBRID RADIATOR INLET HOSE
	Tightening torque for "Major areas involving basic vehicle performance such as moving/turning/stopping": N*m (kgf*cm, ft.*lbf)		N*m (kgf*cm, ft.*lbf): Specified torque
	Adhesive 1324	★	Precoated part











PROCEDURE		PART NAME CODE			
24	DRIVE SHAFT ASSEMBLY	-	-	-	-
25	FRONT EXHAUST PIPE ASSEMBLY	17410	INFO	-	-
26	NO. 2 ENGINE UNDER COVER	51442	-	-	-
27	FRONT FLOOR CENTER BRACE	57533B	-	-	-
28	NO. 1 STEERING COLUMN HOLE COVER SUB-ASSEMBLY	45025D	INFO	-	-
29	NO. 2 STEERING INTERMEDIATE SHAFT ASSEMBLY	45260	INFO	-	-
30	COLUMN HOLE COVER SILENCER SHEET	45259A	-	-	-

	Tightening torque for "Major areas involving basic vehicle performance such as moving/turning/stopping": N*m (kgf*cm, ft.*lbf)		N*m (kgf*cm, ft.*lbf): Specified torque
<ul style="list-style-type: none"> • 	Non-reusable part	-	-





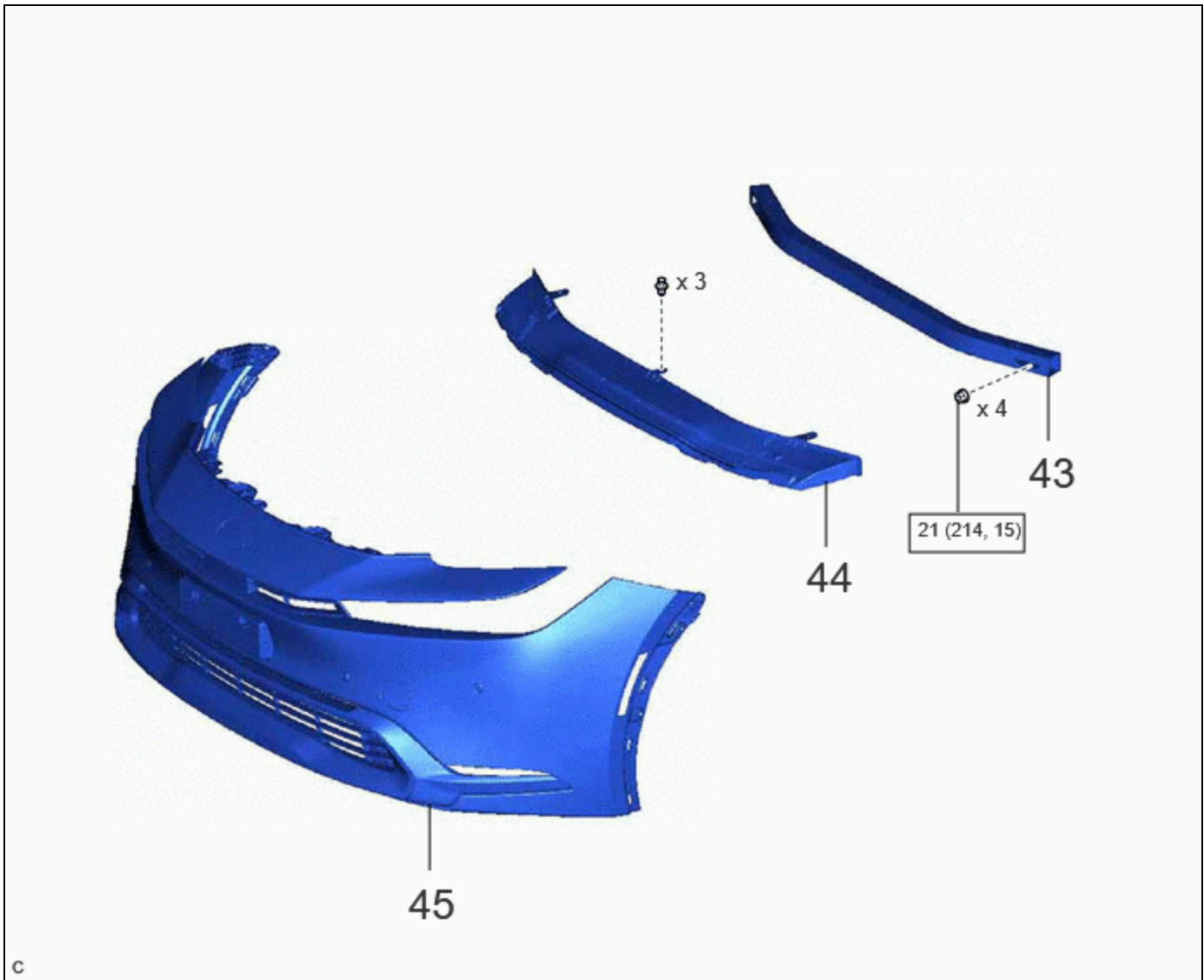

	PROCEDURE	PART NAME CODE			
31	NO. 4 WATER BY-PASS HOSE	16281		-	-
32	FUEL TUBE SUB-ASSEMBLY	23901		-	-
33	WATER HOSE SUB-ASSEMBLY	87209J		-	-
34	NO. 1 FUEL VAPOR FEED HOSE	23826	-	-	-
35	OUTLET NO. 2 INVERTER COOLING HOSE	G922D		-	-
36	NO. 2 RADIATOR HOSE	16572D		-	-

PROCEDURE		PART NAME CODE			
37	NO. 1 RADIATOR HOSE	16571C		-	-
38	DISCHARGE HOSE SUB-ASSEMBLY	88703		-	-
39	SUCTION HOSE SUB-ASSEMBLY	88704		-	-
40	INVERTER RESERVE TANK ASSEMBLY	G910GB		-	-
41	NO. 7 ENGINE WIRE	82127D	-	-	-
42	INVERTER WITH CONVERTER ASSEMBLY	G9200	-	-	-

*1	EFI FUEL PIPE CLAMP	*2	NO. 1 INVERTER RESERVE TANK BRACKET
	N*m (kgf*cm, ft.*lbf): Specified torque	•	Non-reusable part
	Compressor oil ND-OIL 11 or equivalent	-	-



PROCEDURE		PART NAME CODE			
43	NO. 2 FRONT BUMPER REINFORCEMENT	52132A	-	-	-
44	FRONT BUMPER LOWER ABSORBER	52618	-	-	-
45	FRONT BUMPER ASSEMBLY	-	-	-	-

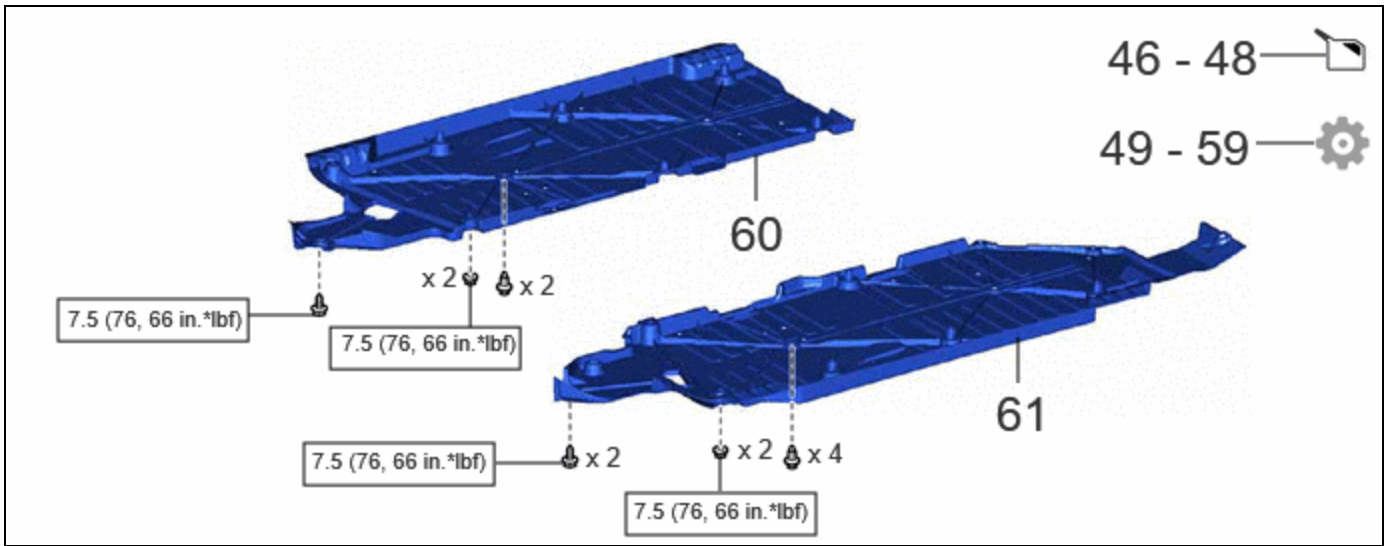

	N*m (kgf*cm, ft.*lbf): Specified torque	-	-
---	---	---	---

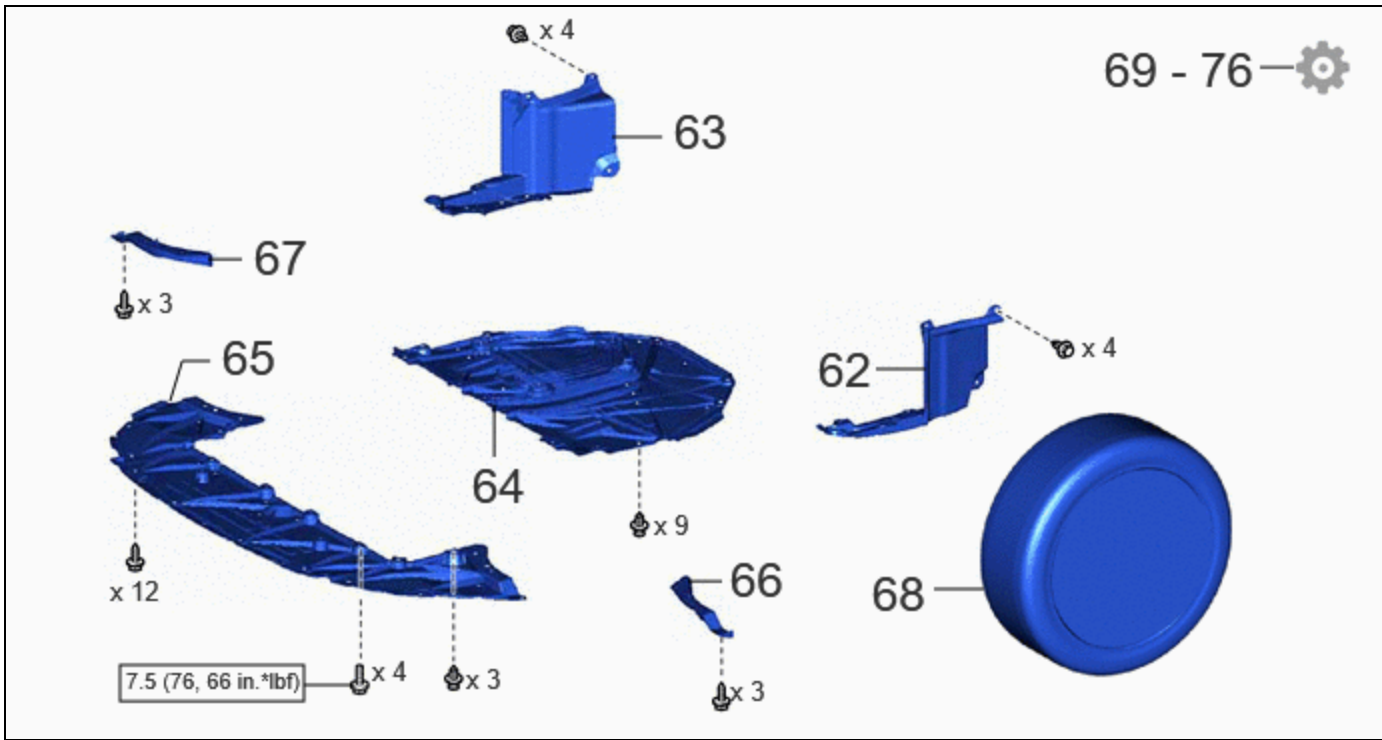

PROCEDURE		PART NAME CODE			
46	ADD ENGINE OIL	-	-	INFO	-
47	ADD ENGINE COOLANT (for Engine)	-	-	INFO	-
48	ADD HYBRID TRANSAXLE FLUID	-	-	INFO	-
49	CHARGE AIR CONDITIONING SYSTEM WITH REFRIGERANT	-	-	-	INFO
50	WARM UP COMPRESSOR	-	-	-	INFO
51	INSPECT HYBRID TRANSAXLE FLUID	-	-	-	INFO
52	INSPECT FOR ENGINE OIL LEAK	-	-	-	INFO
53	INSPECT FOR COOLANT LEAK (for Inverter)	-	-	-	INFO
54	INSPECT FOR COOLANT LEAK (for Engine)	-	-	-	INFO
55	INSPECT FOR REFRIGERANT LEAK	-	-	-	INFO
56	INSPECT FOR FUEL LEAK	-	-	-	INFO
57	INSPECT FOR EXHAUST GAS LEAK	-	-	-	INFO
58	CHECK ENGINE OIL LEVEL	-	-	-	INFO
59	INSPECT RADIATOR RESERVE TANK ENGINE COOLANT LEVEL (for Engine)	-	-	-	INFO
60	FRONT FLOOR COVER RH	58165C	-	-	-
61	FRONT FLOOR COVER LH	58166A	-	-	-

	N*m (kgf*cm, ft.*lbf): Specified torque	-	-
--	---	---	---



PROCEDURE		PART NAME CODE			
62	REAR ENGINE UNDER COVER LH	51444A	-	-	-
63	REAR ENGINE UNDER COVER RH	51443C	-	-	-
64	NO. 1 ENGINE UNDER COVER ASSEMBLY	51410	-	-	-
65	CENTER ENGINE UNDER COVER	51451A	-	-	-
66	FRONT WHEEL OPENING EXTENSION PAD LH	53852B	-	-	-
67	FRONT WHEEL OPENING EXTENSION PAD RH	53851D	-	-	-
68	FRONT WHEELS	-	-	-	-
69	ALIGN FRONT WHEELS FACING STRAIGHT AHEAD	-	-	-	INFO
70	INSPECT AND ADJUST FRONT WHEEL ALIGNMENT	-	-	-	INFO
71	PERFORM INITIALIZATION	-	-	-	INFO
72	INITIALIZATION AFTER RECONNECTING AUXILIARY BATTERY TERMINAL	-	-	-	INFO
73	INSPECT IGNITION TIMING	-	-	-	INFO
74	INSPECT ENGINE IDLE SPEED	-	-	-	INFO
75	INSPECT CO/HC	-	-	-	INFO
76	CHECK SPEED SENSOR SIGNAL	-	-	-	INFO

	N*m (kgf*cm, ft.*lbf): Specified torque	-	-
---	---	---	---

PROCEDURE

1. INSTALL ENGINE MOUNTING INSULATOR SUB-ASSEMBLY RH

HINT:

Perform this procedure only when replacement of the engine mounting insulator sub-assembly RH is necessary.

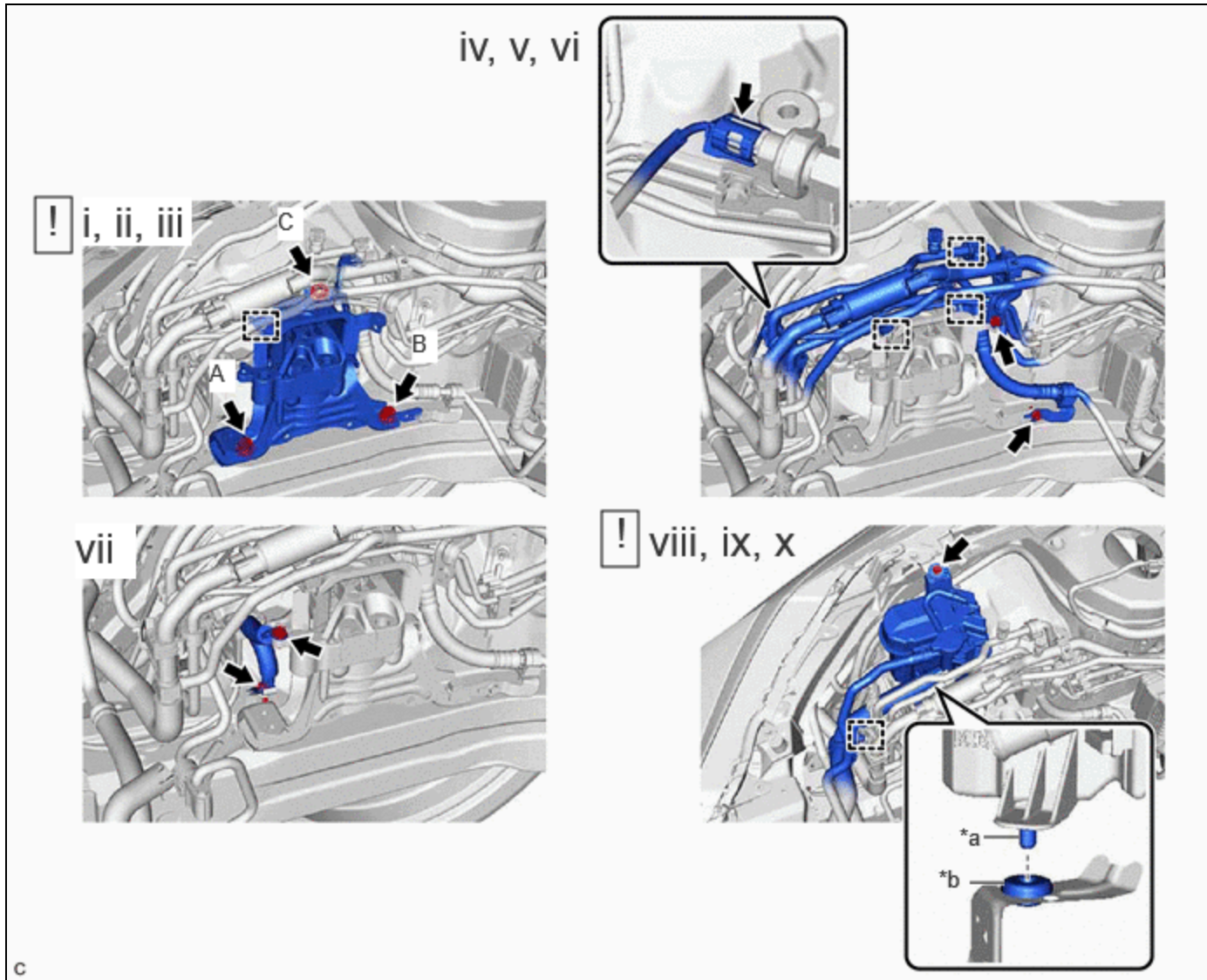

*a	Pin	*b	Grommet
----	-----	----	---------

- (1) Temporarily install the engine mounting insulator sub-assembly RH to the vehicle.
- (2) Install the 2 bolts and nut in the order shown in the illustration.

Torque:

72 N·m {734 kgf·cm, 53 ft·lbf}

NOTICE:

Temporarily tighten the bolt (A), and then fully tighten the 2 bolts and nut in the order of (B), (A) and (C).

(3) Engage the clamp.

(4) Install the 2 bolts.

Torque:

9.8 N·m {100 kgf·cm, 87 in·lbf}

(5) Engage the 3 clamps.

(6) Connect the air conditioner pressure sensor connector.

(7) Install the No. 2 earth wire to the engine mounting insulator sub-assembly RH and vehicle with the 2 bolts.

Torque:

10.5 N·m {107 kgf·cm, 8 ft·lbf}

(8) Fit the pin of the radiator reserve tank assembly into the grommet as shown in the illustration.

(9) Install the radiator reserve tank assembly with the bolt.

Torque:

5.0 N·m {51 kgf·cm, 44 in·lbf}

(10) Engage the clamp.

2. INSTALL ACCUMULATOR ASSEMBLY

HINT:

Perform this procedure only when replacement of the engine mounting insulator RH is necessary.

Click here [INFO](#)

3. INSTALL ENGINE MOUNTING INSULATOR LH

HINT:

Perform this procedure only when replacement of the engine mounting insulator LH is necessary.

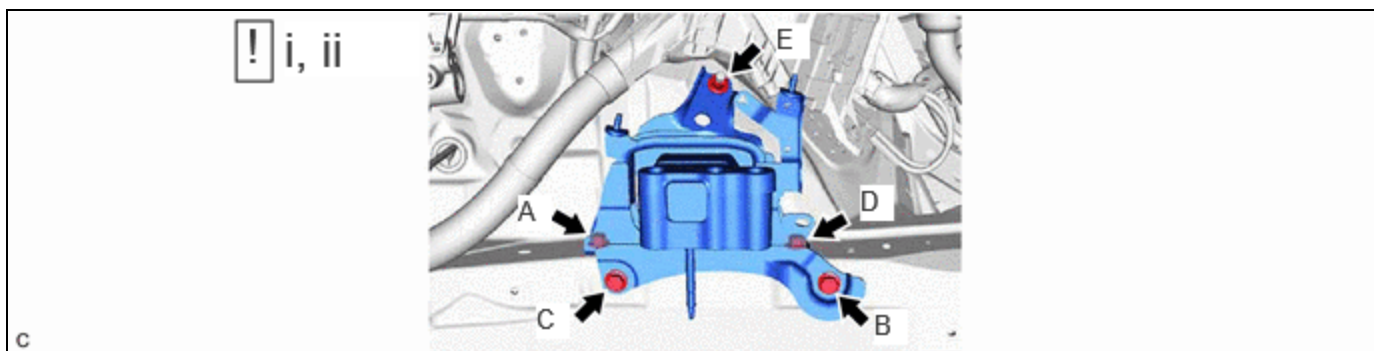

(1) Temporarily install the engine mounting insulator LH to the vehicle.

(2) Install the 4 bolts and nut in the order shown in the illustration.

Torque:

42 N·m {428 kgf·cm, 31 ft·lbf}

NOTICE:

Temporarily tighten the bolt (A), and then fully tighten the 4 bolts and nut in the order of (B), (C), (D), (A) and (E).

4. INSTALL ENGINE HANGERS



Click here [INFO](#)

5. REMOVE ENGINE ASSEMBLY FROM ENGINE STAND

6. INSTALL ENGINE WIRE

HINT:

As the illustration shown is an example, the actual details may differ.

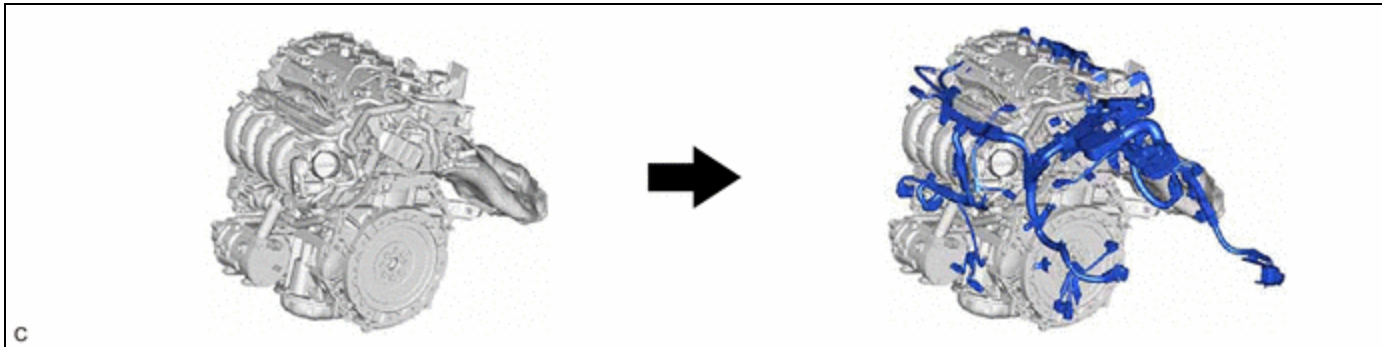

7. INSTALL FLYWHEEL HOUSING UNDER COVER

8. INSTALL COMPRESSOR WITH MOTOR ASSEMBLY



Click here [INFO](#)

9. INSTALL NO. 1 CRANKSHAFT POSITION SENSOR PLATE



Click here [INFO](#)

10. INSTALL FLYWHEEL SUB-ASSEMBLY



Click here [INFO](#)

11. INSTALL TRANSMISSION INPUT DAMPER ASSEMBLY



Click here [INFO](#)

12. INSTALL ENGINE ASSEMBLY

	Click here INFO
---	---

13. INSTALL FLYWHEEL HOUSING SIDE COVER

14. INSTALL STARTER HOLE INSULATOR

Click here [INFO](#)

15. CONNECT ENGINE WIRE

Click here [INFO](#)

16. REMOVE ENGINE HANGERS

17. INSTALL ENGINE MOUNTING BRACKET CAP

18. INSTALL ENGINE ASSEMBLY WITH TRANSAXLE

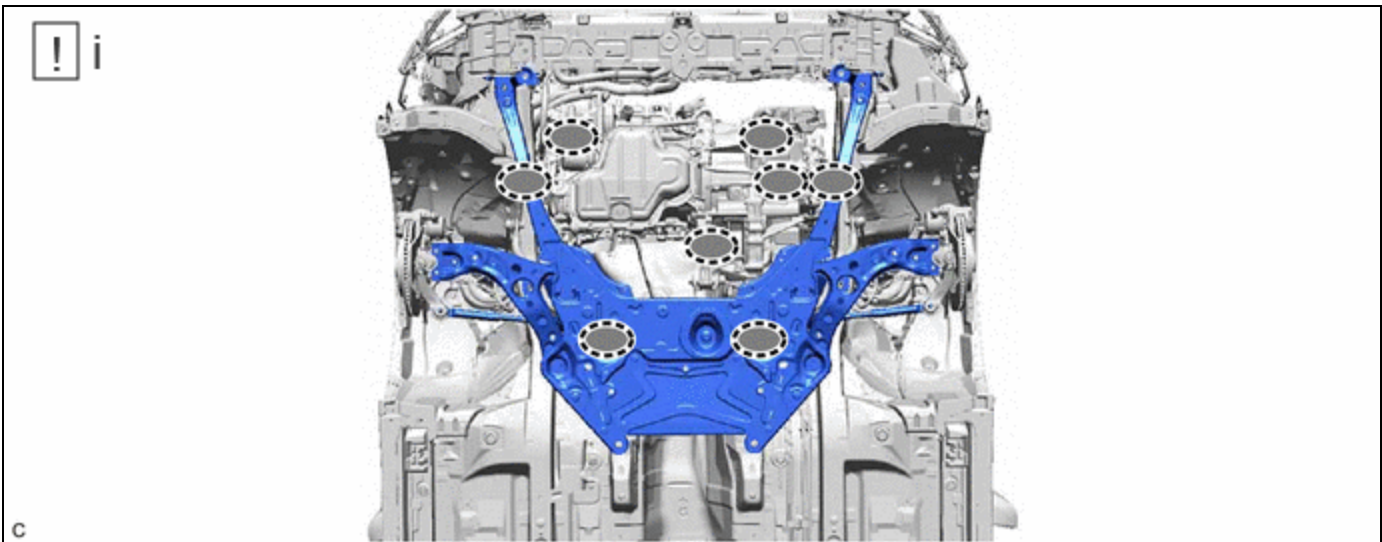

	Attachment Installation Position	-	-
---	----------------------------------	---	---

(1) Using height adjustment attachments and plate lift attachments to keep the engine assembly with transaxle and front suspension crossmember sub-assembly level, set an engine lifter underneath the engine assembly with transaxle and front suspension crossmember sub-assembly.

NOTICE:

- Using height adjustment attachments and plate lift attachments, keep the engine assembly with transaxle horizontal.
- Do not perform any procedures while the engine assembly is suspended because doing so may cause the engine assembly to drop, resulting in injury.

However, the engine assembly needs to be suspended when it is installed to or removed from an engine stand.

- To prevent the oil pan sub-assembly from deforming, do not place any attachments under the oil pan sub-assembly of the engine assembly with transaxle.

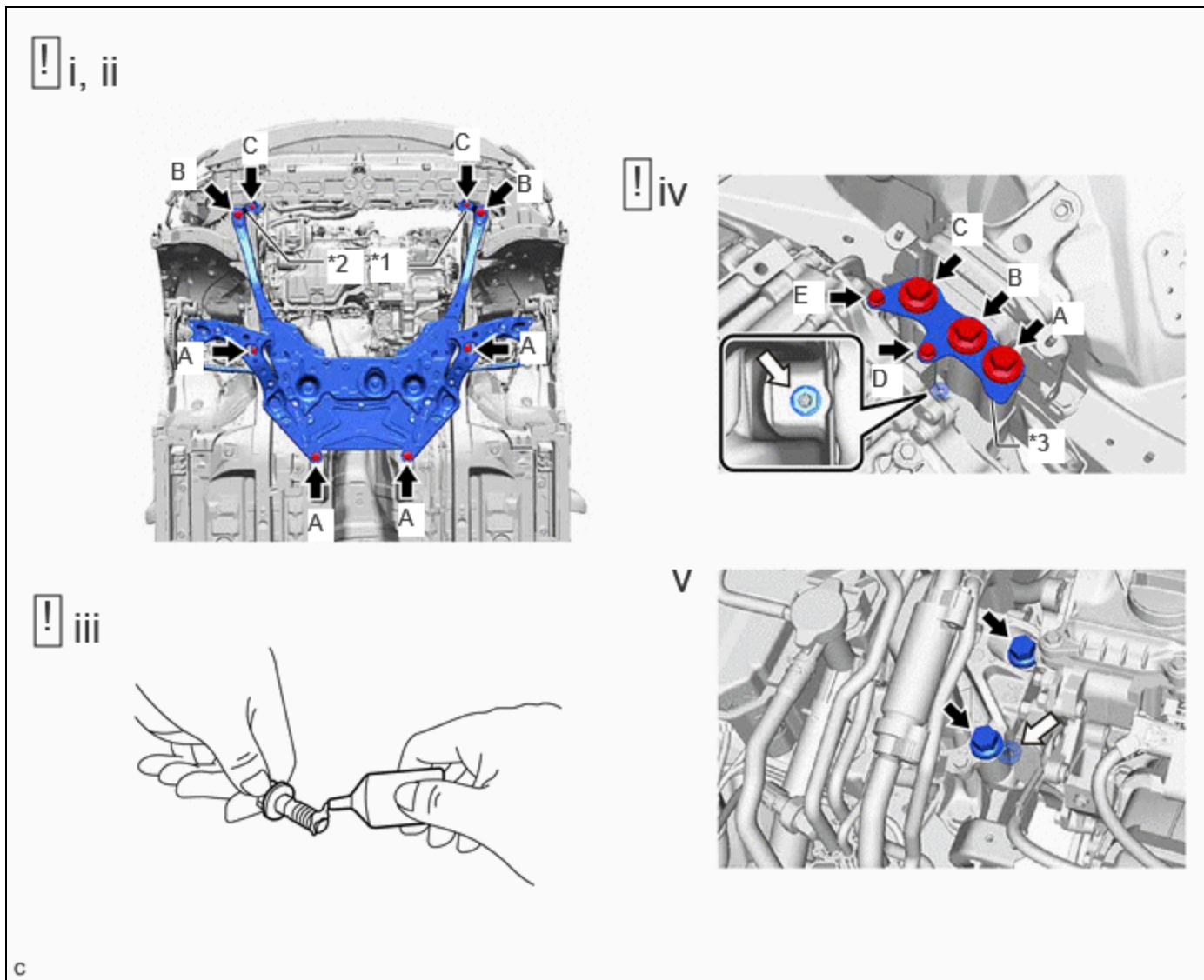

*1	Center Radiator Support LH	*2	Center Radiator Support RH
*3	No. 2 Engine Mounting Stay LH	-	-
	Bolt		Nut

(1) Operate the engine lifter and install the engine assembly with transaxle to the vehicle.

CAUTION:

Do not raise the engine assembly with transaxle more than necessary. If the engine assembly with transaxle is raised excessively, the vehicle may also be lifted up.

NOTICE:

- Make sure that the engine assembly with transaxle is clear of all wiring and hoses.
- While raising the engine assembly with transaxle into the vehicle, do not allow it to contact the vehicle.

(2) Install the front suspension crossmember sub-assembly, center radiator support LH and center radiator support RH to the vehicle with the 8 bolts.

Torque:

Bolt (A) :

141 N·m {1438 kgf·cm, 104 ft·lbf}

Bolt (B) :

32 N·m {326 kgf·cm, 24 ft·lbf}

Bolt (C) :

12 N·m {122 kgf·cm, 9 ft·lbf}

(3) Apply adhesive to 2 or 3 threads at the end of the bolt (D) and bolt (E).

Adhesive:

Toyota Genuine Adhesive 1324, Three Bond 1324 or equivalent

(4) Install the engine mounting insulator LH and No. 2 engine mounting stay LH to the hybrid vehicle transaxle assembly with the 5 bolts and nut in the order shown in the illustration.

Torque:

Bolt (A), (B), (C) :

70 N·m {714 kgf·cm, 52 ft·lbf}

Bolt (D), (E) :

8.0 N·m {82 kgf·cm, 71 in·lbf}

Nut :

20 N·m {204 kgf·cm, 15 ft·lbf}

NOTICE:

Temporarily tighten the bolt (A), and then fully tighten the 5 bolts in the order of (D), (E), (A), (B) and (C).

(5) Install the engine mounting insulator sub-assembly RH to the engine mounting bracket RH with the 2 bolts and nut.

Torque:

Bolt :

72 N·m {734 kgf·cm, 53 ft·lbf}

Nut :

41 N·m {418 kgf·cm, 30 ft·lbf}

(c) Perform "Inspection After Repair" after replacing the engine assembly.

Click here [INFO](#)

19. INSTALL FRONT BUMPER EXTENSION SUB-ASSEMBLY LH

Torque:

12 N·m {122 kgf·cm, 9 ft·lbf}

20. INSTALL FRONT BUMPER EXTENSION SUB-ASSEMBLY RH

Torque:

12 N·m {122 kgf·cm, 9 ft·lbf}

21. INSTALL NO. 2 CROSSMEMBER GUSSET LH

Torque:

72 N·m {734 kgf·cm, 53 ft·lbf}

22. INSTALL NO. 2 CROSSMEMBER GUSSET RH

Torque:

72 N·m {734 kgf·cm, 53 ft·lbf}

23. INSTALL INVERTER WATER PUMP WITH MOTOR ASSEMBLY



Click here [INFO](#)

24. INSTALL DRIVE SHAFT ASSEMBLY

Click here [INFO](#)

25. INSTALL FRONT EXHAUST PIPE ASSEMBLY

	Click here INFO
---	---------------------------------

26. INSTALL NO. 2 ENGINE UNDER COVER

Click here [INFO](#)

27. INSTALL FRONT FLOOR CENTER BRACE

Click here [INFO](#)

28. CONNECT NO. 1 STEERING COLUMN HOLE COVER SUB-ASSEMBLY

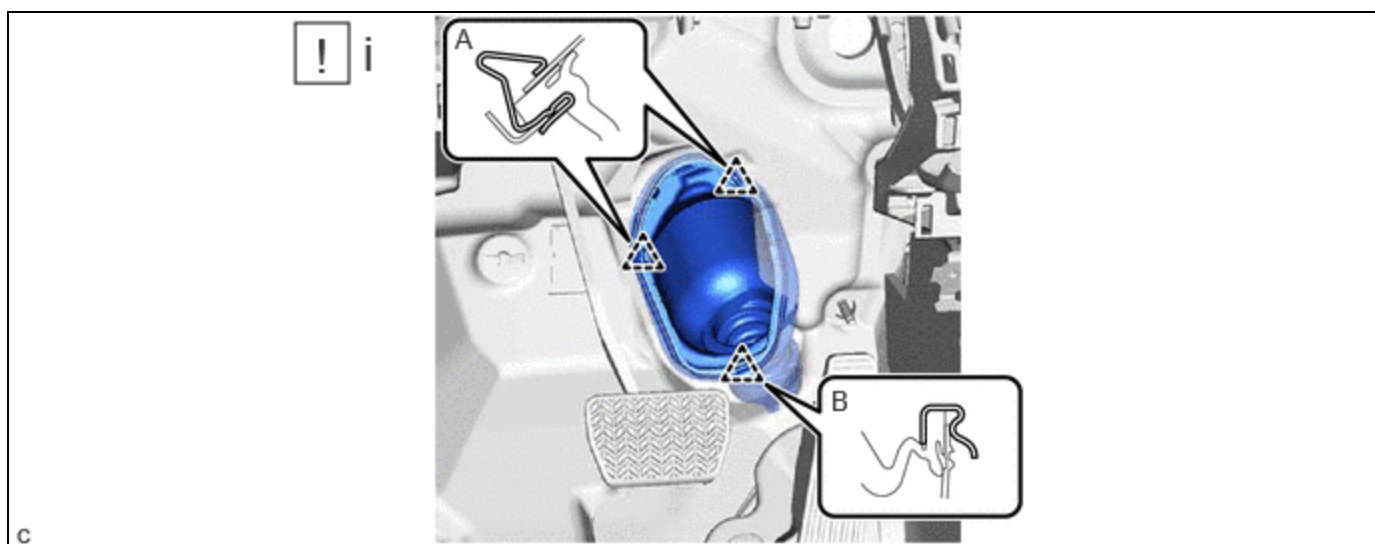

(1) Connect the No. 1 steering column hole cover sub-assembly by the below procedure.

1. Engage the clip (B) to the vehicle body.
2. Engage the 2 clips (A) to connect the No. 1 steering column hole cover sub-assembly to the vehicle body.

NOTICE:

- Be careful not to damage the lip of the No. 1 steering column hole cover sub-assembly.
- Check that the No. 1 steering column hole cover sub-assembly is securely connect.
- Check that the No. 1 steering column hole cover sub-assembly and vehicle body are in close contact with one another.

29. CONNECT NO. 2 STEERING INTERMEDIATE SHAFT ASSEMBLY

	Click here INFO
---	---------------------------------

30. INSTALL COLUMN HOLE COVER SILENCER SHEET

Click here [INFO](#)

31. CONNECT NO. 4 WATER BY-PASS HOSE

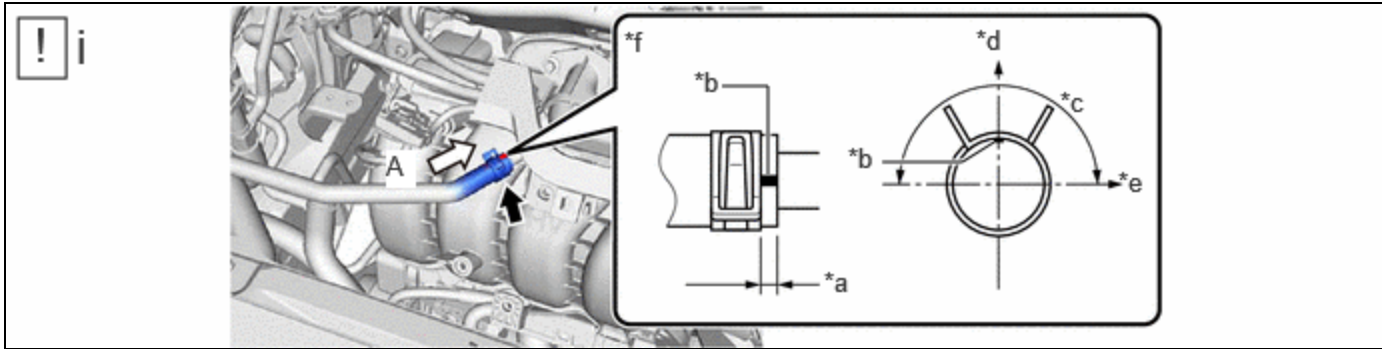

*a	2 to 9 mm (0.0787 to 0.354 in.)	*b	Paint Mark
*c	180° (Claw of Clip Location)	*d	Upper Side
*e	Front Side	*f	View A

(1) Connect the No. 4 water by-pass hose to the No. 3 water by-pass pipe and slide the clip to secure it.

NOTICE:

Make sure that the claws of the clip are positioned within the area shown in the illustration.

32. CONNECT FUEL TUBE SUB-ASSEMBLY



*a	Claw	-	-
----	------	---	---

(1) Connect the fuel tube sub-assembly to the fuel pipe.



Click here [INFO](#)

(2) Engage the claw and install the EFI fuel pipe clamp as shown in the illustration.

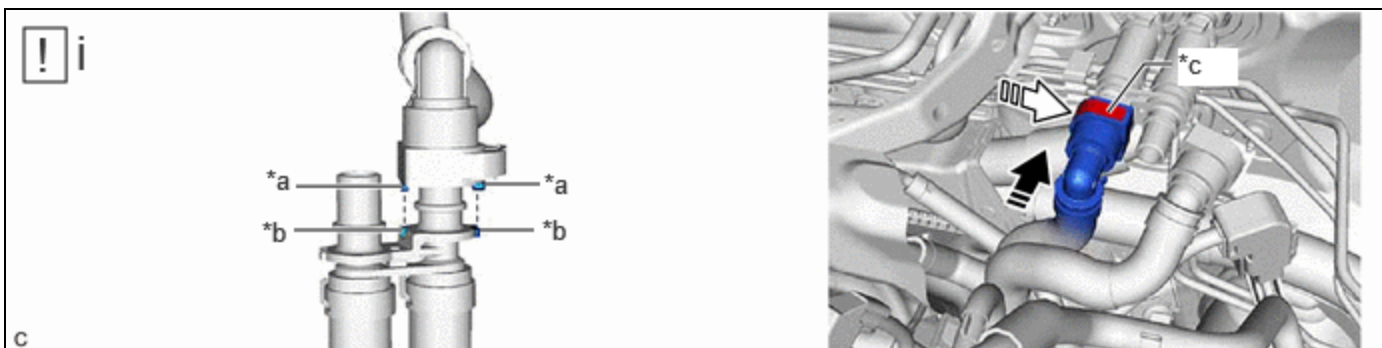
33. CONNECT WATER HOSE SUB-ASSEMBLY



*a	Protrusion	*b	Cutout
----	------------	----	--------

*c	Retainer	-	-
	Push		Push in



(1) Connect the water hose sub-assembly connector to the water hose.

NOTICE:

Check that there is no damage or foreign matter on the connecting parts of the water lines.

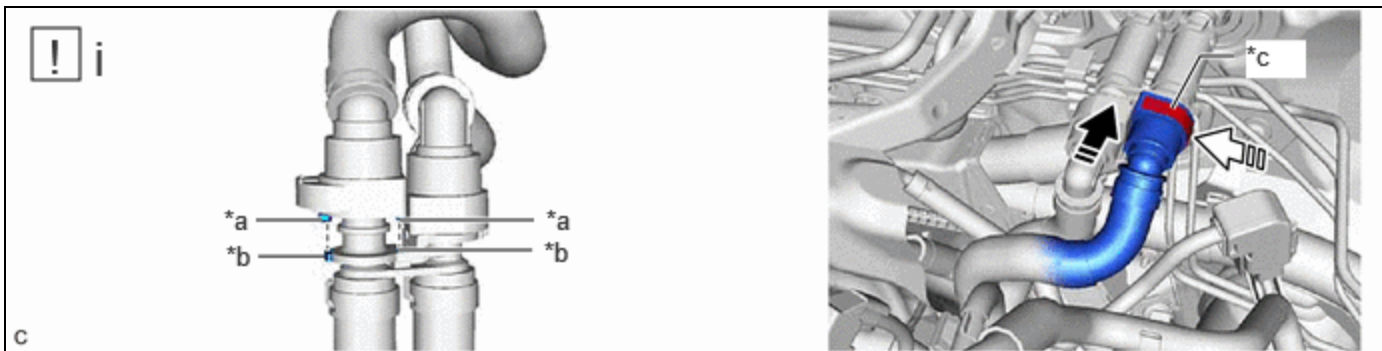
1. Align the protrusions of the water hose sub-assembly connector with the cutouts in the water hose and securely insert the water hose sub-assembly connector to the stopper of the pipe.
2. Push in the retainer.
3. Check that the water hose and water hose sub-assembly connector are securely connected by pulling on them.



*a	Protrusion	*b	Cutout
*c	Retainer	-	-
	Push		Push in

(1) Connect the water hose sub-assembly connector to the water hose.

NOTICE:

Check that there is no damage or foreign matter on the connecting parts of the water lines.

1. Align the protrusions of the water hose sub-assembly connector with the cutouts in the water hose and securely insert the water hose sub-assembly connector to the stopper of the pipe.
2. Push in the retainer.
3. Check that the water hose and water hose sub-assembly connector are securely connected by pulling on them.

34. INSTALL NO. 1 FUEL VAPOR FEED HOSE

35. CONNECT OUTLET NO. 2 INVERTER COOLING HOSE

	Click here INFO
---	---------------------------------

36. CONNECT NO. 2 RADIATOR HOSE

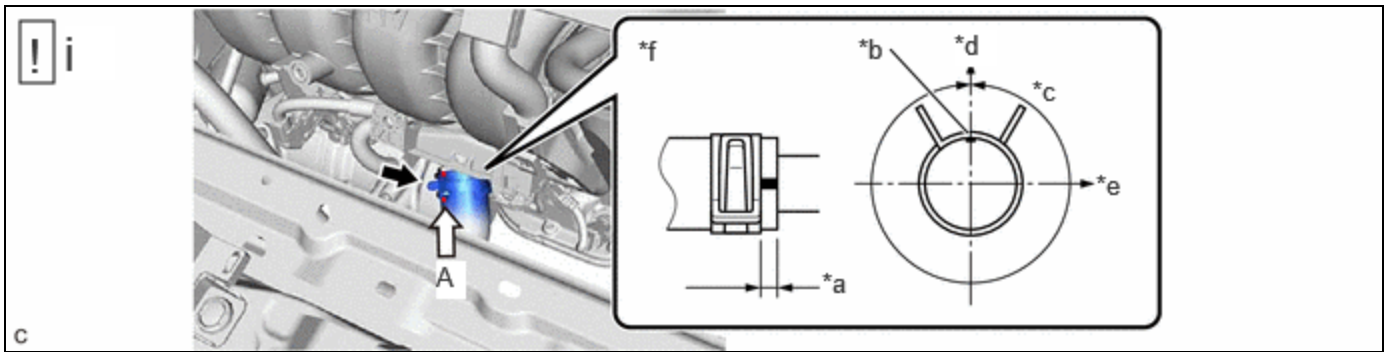

*a	2 to 7 mm (0.0787 to 0.276 in.)	*b	Paint Mark
*c	360° (Claw of Clip Location)	*d	Upper Side
*e	LH Side	*f	View A

(1) Connect the No. 2 radiator hose to the water inlet with thermostat sub-assembly and slide the clip to secure it.

NOTICE:

- Make sure to slide the No. 2 radiator hose until it contacts the hose stopper.
- Make sure that the claws of the clip are within the location shown in the illustration.

37. CONNECT NO. 1 RADIATOR HOSE

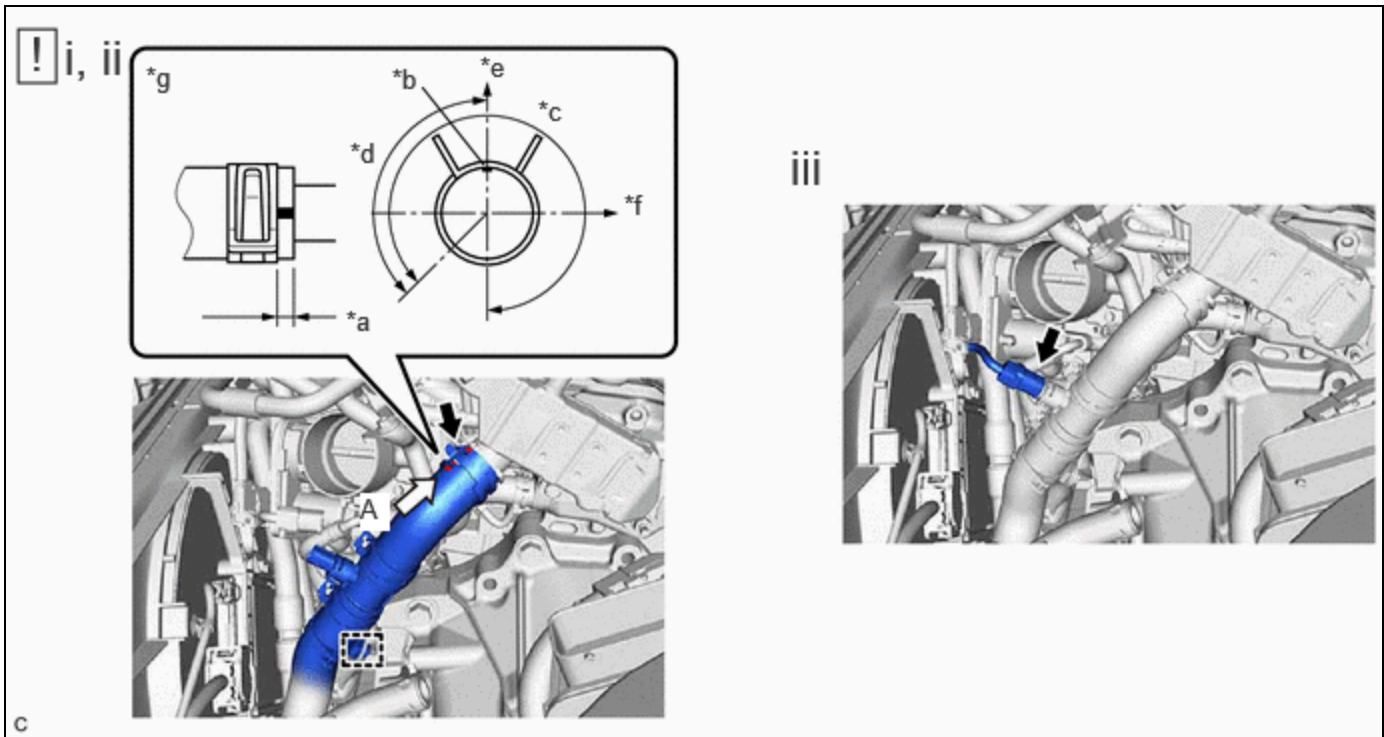

*a	2 to 7 mm (0.0787 to 0.276 in.)	*b	Paint Mark
*c	315° (Claw of Clip Location)	*d	135°
*e	Upper Side	*f	LH Side
*g	View A	-	-

(1) Connect the No. 1 radiator hose to the water outlet sub-assembly and slide the clip to secure it.

NOTICE:

- Make sure to slide the No. 1 radiator hose until it contacts the hose stopper.
- Make sure that the claws of the clip are within the location shown in the illustration.

- (2) Engage the clamp.
- (3) Connect the engine coolant temperature sensor connector.

38. CONNECT DISCHARGE HOSE SUB-ASSEMBLY

	Click here INFO
---	---------------------------------

39. CONNECT SUCTION HOSE SUB-ASSEMBLY

	Click here INFO
---	---------------------------------

40. CONNECT INVERTER RESERVE TANK ASSEMBLY

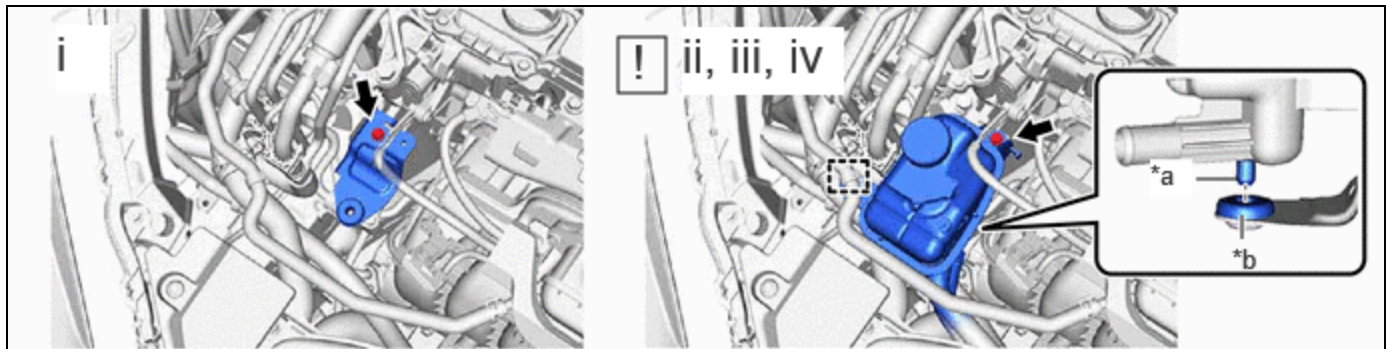

*a	Pin	*b	Grommet
----	-----	----	---------

- (1) Install the No. 1 inverter reserve tank bracket with the bolt.

Torque:

5.0 N·m {51 kgf·cm, 44 in·lbf}

- (2) Fit the pin of the inverter reserve tank assembly into the grommet as shown in the illustration.
- (3) Connect the inverter reserve tank assembly with the bolt.

Torque:

5.0 N·m {51 kgf·cm, 44 in·lbf}

- (4) Engage the clamp.

41. CONNECT NO. 7 ENGINE WIRE

Torque:

10 N·m {102 kgf·cm, 7 ft·lbf}

42. INSTALL INVERTER WITH CONVERTER ASSEMBLY

Click here [INFO](#)

43. INSTALL NO. 2 FRONT BUMPER REINFORCEMENT

Click here [INFO](#)

44. INSTALL FRONT BUMPER LOWER ABSORBER

45. INSTALL FRONT BUMPER ASSEMBLY

Click here [INFO](#)

46. ADD ENGINE OIL

Click here [INFO](#)

47. ADD ENGINE COOLANT (for Engine)

Click here [INFO](#)

48. ADD HYBRID TRANSAXLE FLUID

Click here [INFO](#)

49. CHARGE AIR CONDITIONING SYSTEM WITH REFRIGERANT

Click here [INFO](#)

50. WARM UP COMPRESSOR

Click here [INFO](#)

51. INSPECT HYBRID TRANSAXLE FLUID

Click here [INFO](#)

52. INSPECT FOR ENGINE OIL LEAK

Click here [INFO](#)

53. INSPECT FOR COOLANT LEAK (for Inverter)

Click here [INFO](#)

54. INSPECT FOR COOLANT LEAK (for Engine)

Click here [INFO](#)

55. INSPECT FOR REFRIGERANT LEAK

Click here [INFO](#)

56. INSPECT FOR FUEL LEAK

Click here [INFO](#)

57. INSPECT FOR EXHAUST GAS LEAK

Click here [INFO](#)

58. CHECK ENGINE OIL LEVEL

Click here [INFO](#)

59. INSPECT RADIATOR RESERVE TANK ENGINE COOLANT LEVEL (for Engine)

Click here [INFO](#)

60. INSTALL FRONT FLOOR COVER RH

Click here [INFO](#)

61. INSTALL FRONT FLOOR COVER LH

Click here [INFO](#)

62. INSTALL REAR ENGINE UNDER COVER LH

63. INSTALL REAR ENGINE UNDER COVER RH

64. INSTALL NO. 1 ENGINE UNDER COVER ASSEMBLY

65. INSTALL CENTER ENGINE UNDER COVER

Torque:

Bolt :

7.5 N·m {76 kgf·cm, 66 in·lbf}

66. INSTALL FRONT WHEEL OPENING EXTENSION PAD LH

67. INSTALL FRONT WHEEL OPENING EXTENSION PAD RH

68. INSTALL FRONT WHEELS

Click here [INFO](#)

69. ALIGN FRONT WHEELS FACING STRAIGHT AHEAD

70. INSPECT AND ADJUST FRONT WHEEL ALIGNMENT

Click here [INFO](#)

71. PERFORM INITIALIZATION

Click here [INFO](#)

72. INITIALIZATION AFTER RECONNECTING AUXILIARY BATTERY TERMINAL

HINT:

When disconnecting and reconnecting the auxiliary battery, there is an automatic learning function that completes learning when the respective system is used.

Click here [INFO](#)

73. INSPECT IGNITION TIMING

Click here [INFO](#)

74. INSPECT ENGINE IDLE SPEED

Click here [INFO](#)

75. INSPECT CO/HC

Click here [INFO](#)

76. CHECK SPEED SENSOR SIGNAL

Click here [INFO](#)

