

Last Modified: 12-04-2024	6.11:8.1.0	Doc ID: RM100000002BO76
Model Year Start: 2023	Model: Prius Prime	Prod Date Range: [03/2023 -]
Title: AXLE AND DIFFERENTIAL: REAR AXLE CARRIER (for AWD): REMOVAL; 2023 - 2024 MY Prius Prius Prime [03/2023 -]		

REMOVAL

CAUTION / NOTICE / HINT

The necessary procedures (adjustment, calibration, initialization, or registration) that must be performed after parts are removed and installed, or replaced during rear axle carrier sub-assembly removal/installation are shown below.

Necessary Procedures After Parts Removed/Installed/Replaced

REPLACED PART OR PERFORMED PROCEDURE	NECESSARY PROCEDURE	EFFECT/INOPERATIVE FUNCTION WHEN NECESSARY PROCEDURE NOT PERFORMED	LINK
Rear wheel alignment adjustment	Perform "Calibration"	<ul style="list-style-type: none"> • DTCs are stored • ABS warning light illuminates • Brake system warning light (yellow indicator) illuminates • Slip indicator light illuminates • Electronically controlled brake system disabled or malfunctions 	INFO
Tires	<ul style="list-style-type: none"> • Initialization*1*2 • Tire Position Identification*1*2 	Tire Pressure Warning System	Refer to Procedures Necessary When Replacing Parts (for Tire Pressure Warning System) INFO
	Rear television camera assembly optical axis (Back camera position setting)*3	Parking Assist Monitor System	INFO
	Parking assist ECU initialization*3	Panoramic View Monitor System	INFO
Advanced Park		INFO	
Suspension parts	Rear television camera assembly optical axis (Back camera position	Parking Assist Monitor System	INFO

*1: Also necessary after performing a tire rotation.

*2: It is not necessary to perform this procedure if the tire pressure warning valve and transmitters are installed to the same location.

*3: The vehicle height changes because of suspension or tire replacement.

REPLACED PART OR PERFORMED PROCEDURE	NECESSARY PROCEDURE	EFFECT/INOPERATIVE FUNCTION WHEN NECESSARY PROCEDURE NOT PERFORMED	LINK
	setting)		
	Parking assist ECU initialization	Panoramic View Monitor System	INFO
		Advanced Park	INFO
<p>*1: Also necessary after performing a tire rotation.</p> <p>*2: It is not necessary to perform this procedure if the tire pressure warning valve and transmitters are installed to the same location.</p> <p>*3: The vehicle height changes because of suspension or tire replacement.</p>			

HINT:

When the cable is disconnected / reconnected to the auxiliary battery terminal, systems temporarily stop operating. However, each system has a function that completes learning the first time the system is used.

Learning completes when vehicle is driven

EFFECT/INOPERATIVE FUNCTION WHEN NECESSARY PROCEDURE NOT PERFORMED	NECESSARY PROCEDURE	LINK
Front Camera System	Drive the vehicle straight ahead at 35 km/h (22 mph) or more for 5 second or more.	INFO

Learning completes when vehicle is operated normally

EFFECT/INOPERATIVE FUNCTION WHEN NECESSARY PROCEDURE NOT PERFORMED	NECESSARY PROCEDURE	LINK
Power Door Lock Control System*1 <ul style="list-style-type: none"> Back door opener 	Perform door unlock operation with door control switch or electrical key transmitter sub-assembly switch.	INFO
Power Back Door System*2	Reset back door close position	INFO
Air Conditioning System	<p>for HEV Model:</p> <p>After the ignition switch is turned to ON, the servo motor standard position is recognized.</p> <p>for PHEV Model:</p> <p>After the ignition switch is turned to ON, the servo motor and expansion valve standard position is recognized.</p>	-
<p>*1: w/o Power Back Door System</p> <p>*2: w/ Power Back Door System</p>		

CAUTION / NOTICE / HINT**NOTICE:**

- When the brake pedal is first depressed after replacing the brake pads or pushing back the disc brake piston, DTCs may be stored. As there is no malfunction, clear the DTC.
- While the auxiliary battery is connected, even if the ignition switch is off, the brake control system activates when the brake pedal is depressed or any door courtesy switch turns on. Therefore, when servicing the brake system components, do not operate the brake pedal or open/close the doors while the auxiliary battery is connected.

CAUTION / NOTICE / HINT

HINT:

- Use the same procedure for the RH and LH sides.
- The following procedure is for the LH side.

CAUTION / NOTICE / HINT

COMPONENTS (REMOVAL)

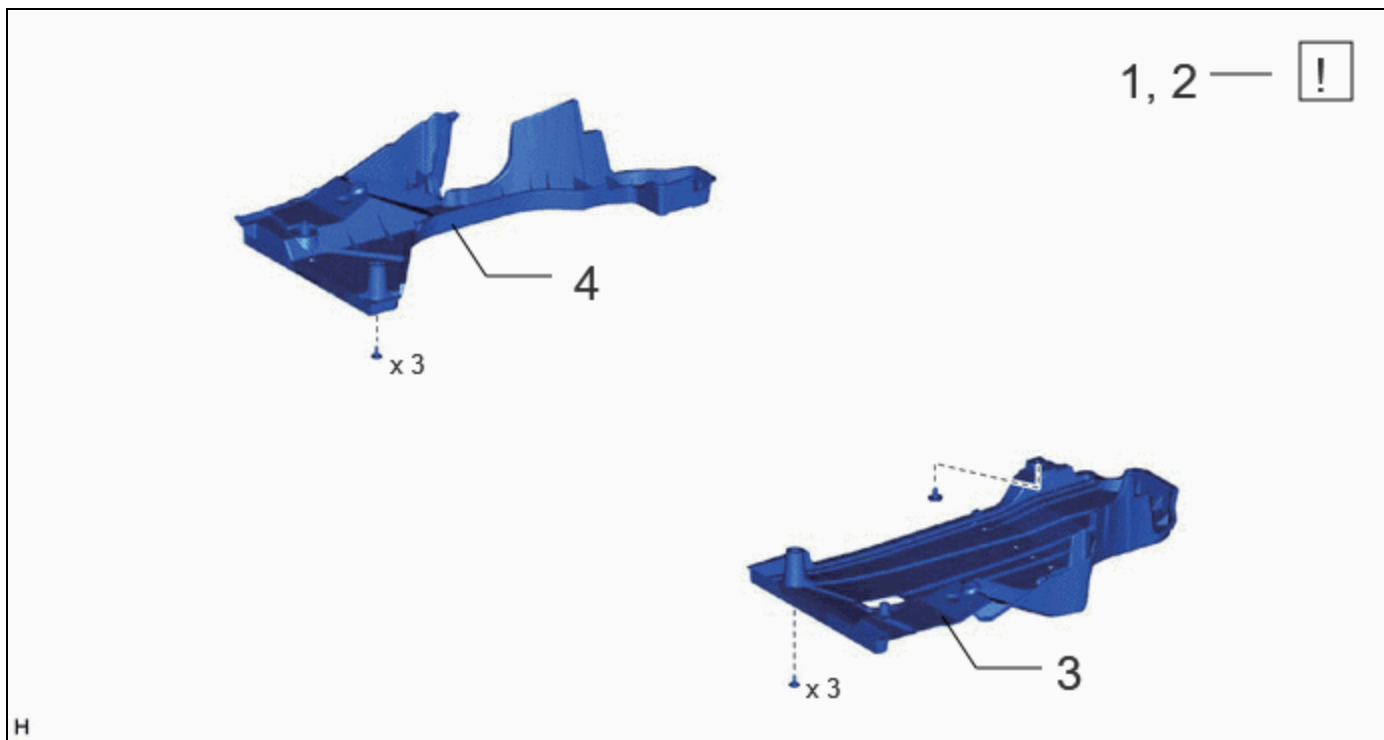

	PROCEDURE	PART NAME CODE			
1	PRECAUTION	-	INFO	-	-
2	DISABLE BRAKE CONTROL	-	INFO	-	-
3	REAR FLOOR SIDE MEMBER COVER LH	57628E	-	-	-
4	REAR FLOOR SIDE MEMBER COVER RH	57627G	-	-	-

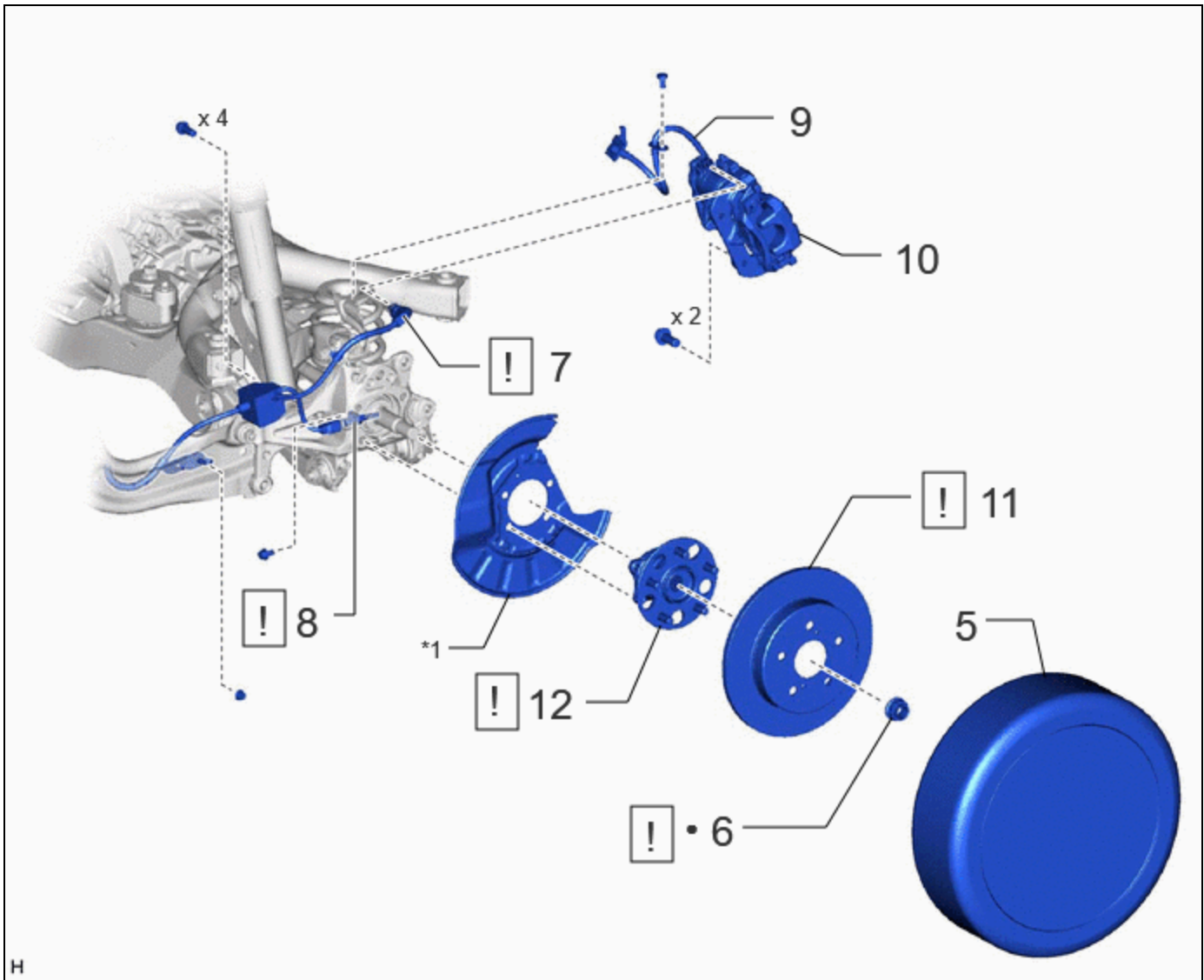

PROCEDURE		PART NAME CODE			
5	REAR WHEEL	-	-	-	-
6	REAR AXLE SHAFT NUT	42312B	INFO	-	-
7	NO. 2 PARKING BRAKE WIRE ASSEMBLY	890C0A	INFO	-	-
8	REAR SKID CONTROL SENSOR	89544E	INFO	-	-
9	REAR FLEXIBLE HOSE	47319F	-	-	-
10	REAR DISC BRAKE CALIPER ASSEMBLY	-	-	-	-
11	REAR DISC	42431	-	-	-
12	REAR AXLE HUB AND BEARING ASSEMBLY	42450B	INFO	-	-

*1	REAR DISC BRAKE DUST COVER SUB-ASSEMBLY	-	-
•	Non-reusable part	-	-

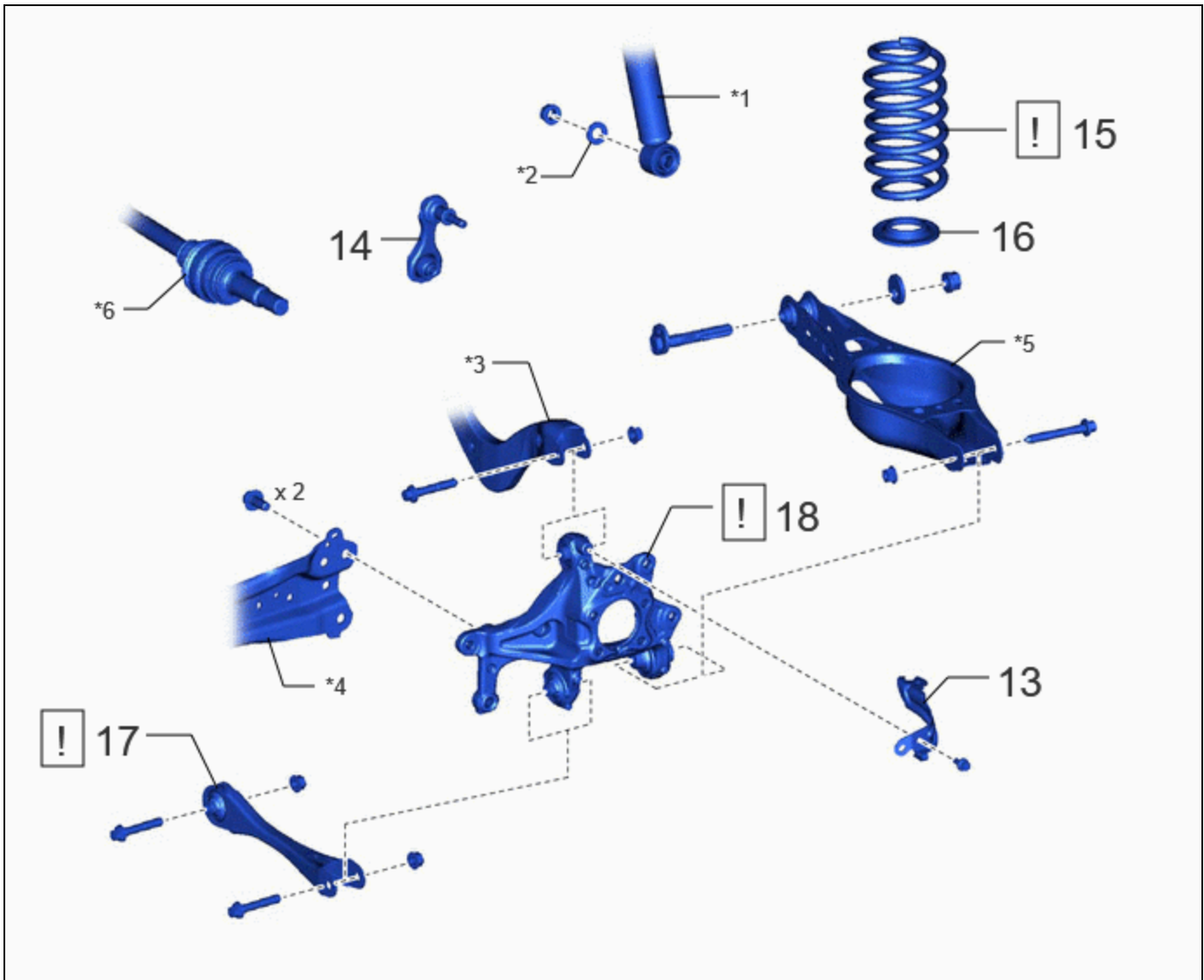

PROCEDURE		PART NAME CODE	!		
13	NO. 4 FLEXIBLE HOSE BRACKET	47354B	-	-	-
14	REAR STABILIZER LINK ASSEMBLY	48840A	-	-	-
15	REAR COIL SPRING	48231B	INFO	-	-
16	REAR LOWER COIL SPRING INSULATOR	48258C	-	-	-
17	REAR NO. 1 SUSPENSION ARM ASSEMBLY	48720A	INFO	-	-
18	REAR AXLE CARRIER SUB-ASSEMBLY	42305	INFO	-	-

*1	REAR SHOCK ABSORBER ASSEMBLY	*2	PLATE WASHER
*3	REAR UPPER CONTROL ARM ASSEMBLY	*4	REAR TRAILING ARM ASSEMBLY
*5	REAR NO. 2 SUSPENSION ARM ASSEMBLY	*6	REAR DRIVE SHAFT ASSEMBLY

PROCEDURE

1. PRECAUTION

	<p>NOTICE:</p> <p>After the ignition switch is turned off, there may be a waiting time before disconnecting the negative (-) auxiliary battery terminal.</p> <p>Click here INFO</p>
---	--

2. DISABLE BRAKE CONTROL

	<p>Click here INFO</p>
---	--

3. REMOVE REAR FLOOR SIDE MEMBER COVER LH

Click here [INFO](#)

4. REMOVE REAR FLOOR SIDE MEMBER COVER RH

Click here [INFO](#)

5. REMOVE REAR WHEEL

Click here [INFO](#)

6. REMOVE REAR AXLE SHAFT NUT

	<p>Click here INFO</p>
---	--

7. SEPARATE NO. 2 PARKING BRAKE WIRE ASSEMBLY

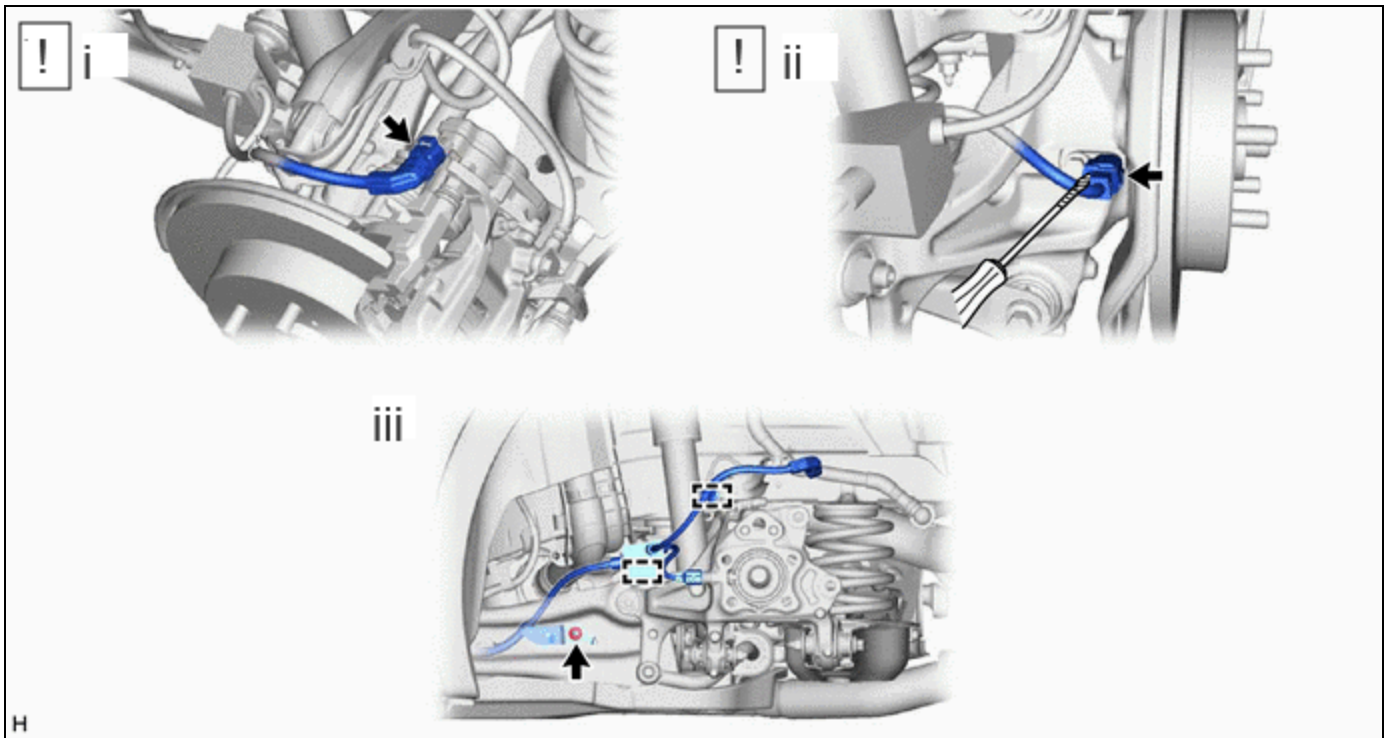

(1) Disconnect the No. 2 parking brake wire assembly connector from the parking brake actuator assembly.

NOTICE:

- Remove any dirt or foreign matter on and around the No. 2 parking brake wire assembly connector before performing this step.
- Do not allow water, oil or dirt to enter the No. 2 parking brake wire assembly connector.

(2) Using a screwdriver with its tip wrapped with protective tape, disconnect the No. 2 parking brake wire assembly connector from the rear skid control sensor.

NOTICE:

- Remove any dirt or foreign matter on and around the No. 2 parking brake wire assembly connector before performing this step.
- Do not allow water, oil or dirt to enter the No. 2 parking brake wire assembly connector.
- Be careful not to damage the rear skid control sensor or connector cover.

(3) Remove the nut, disengage the 2 clamps and separate the No. 2 parking brake wire assembly from the rear flexible hose bracket and rear trailing arm assembly.

8. REMOVE REAR SKID CONTROL SENSOR

	Click here INFO
---	---------------------------------

9. SEPARATE REAR FLEXIBLE HOSE

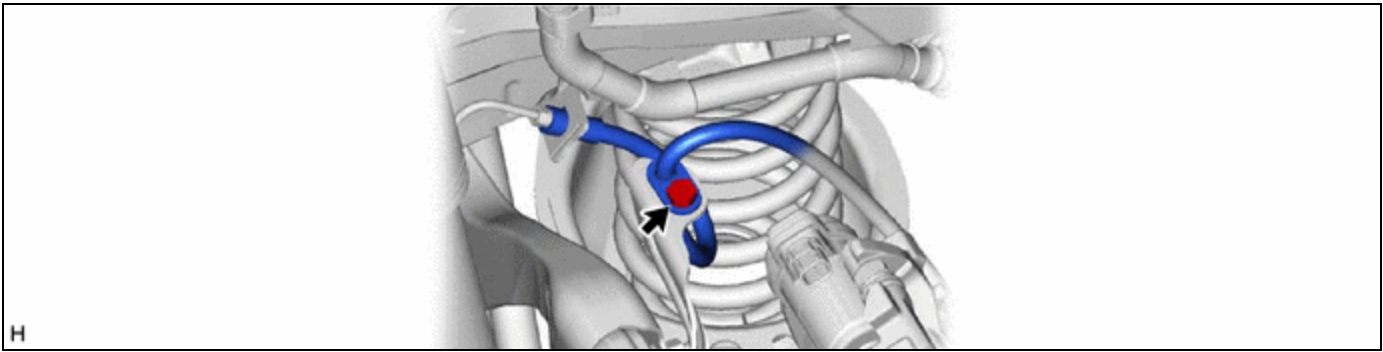

10. SEPARATE REAR DISC BRAKE CALIPER ASSEMBLY

Click here [INFO](#)

11. REMOVE REAR DISC

	Click here INFO
---	---------------------------------

12. REMOVE REAR AXLE HUB AND BEARING ASSEMBLY

	Click here INFO
--	---------------------------------

13. REMOVE NO. 4 FLEXIBLE HOSE BRACKET

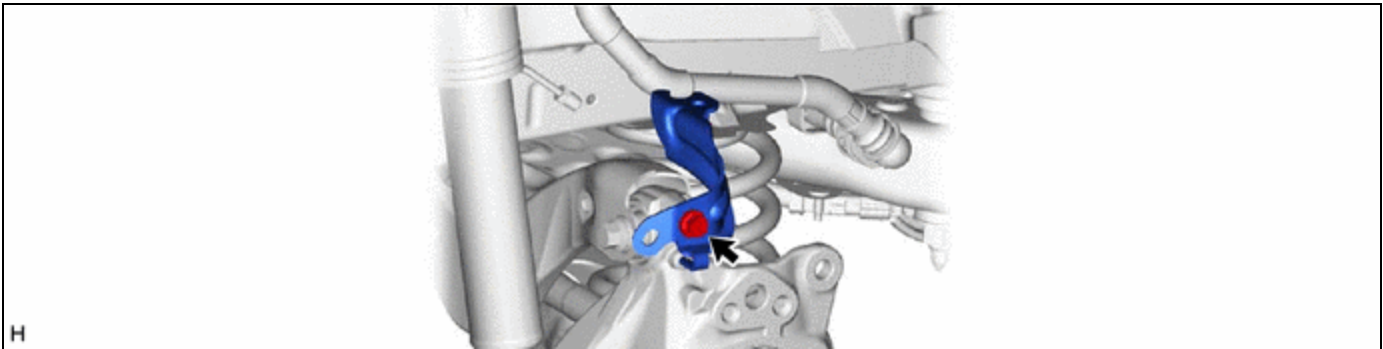

14. REMOVE REAR STABILIZER LINK ASSEMBLY

Click here [INFO](#)

15. REMOVE REAR COIL SPRING

	Click here INFO
---	---------------------------------

16. REMOVE REAR LOWER COIL SPRING INSULATOR

Click here [INFO](#)

17. REMOVE REAR NO. 1 SUSPENSION ARM ASSEMBLY

	Click here INFO
---	---

18. REMOVE REAR AXLE CARRIER SUB-ASSEMBLY

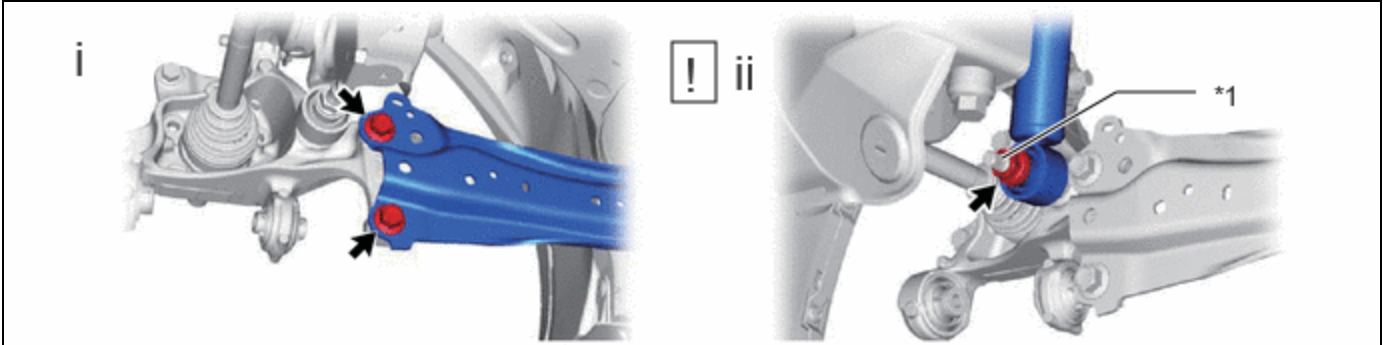

*1	Rear Axle Carrier Pin	-	-
----	-----------------------	---	---

- (1) Loosen the 2 bolts.
- (2) Loosen the nut of the rear shock absorber assembly.

NOTICE:

Hold the rear axle carrier pin while rotating the nut.

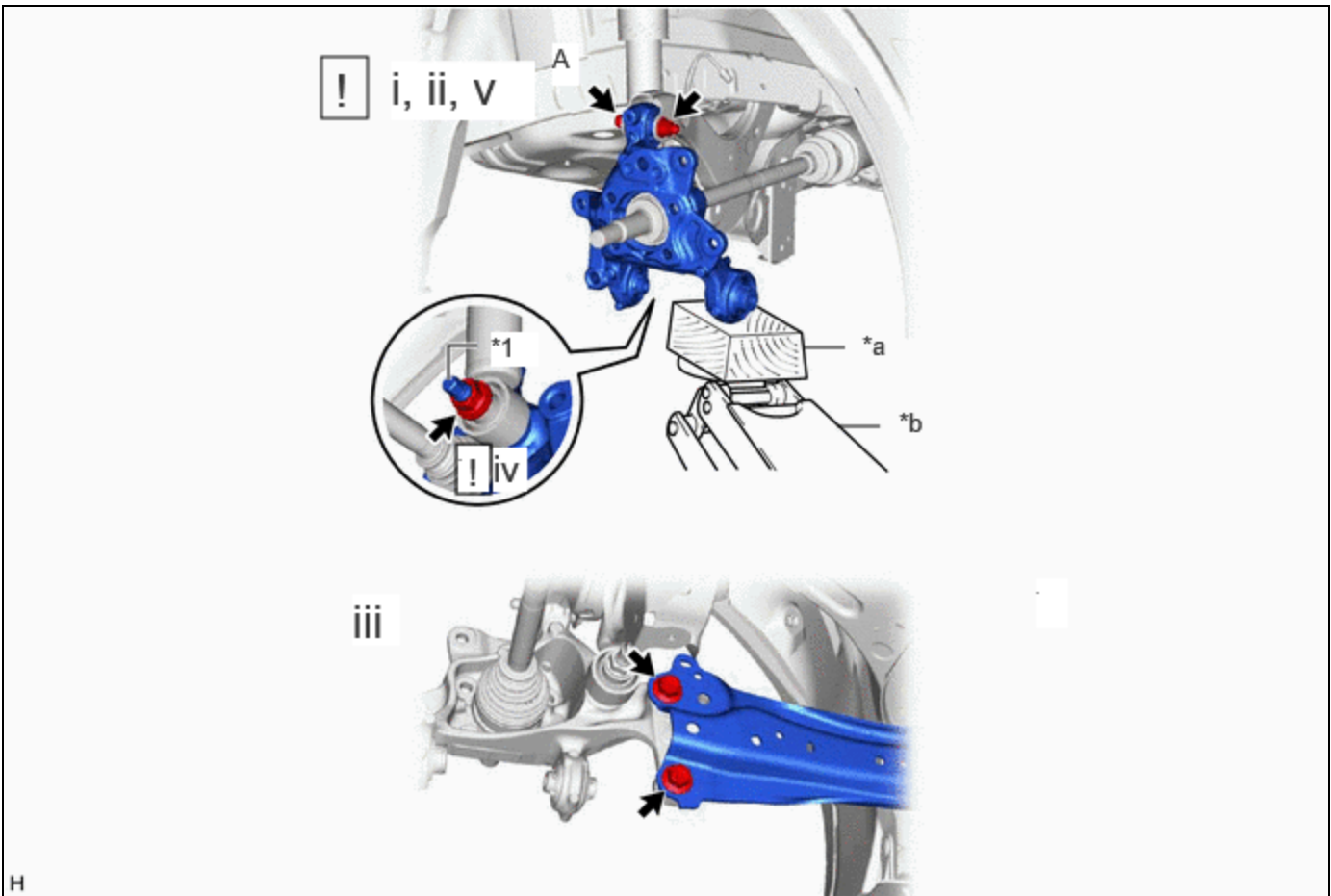

*1	Rear Axle Carrier Pin	-	-
----	-----------------------	---	---

*a	Wooden Block	*b	Jack
----	--------------	----	------

(1) Using a jack and wooden block, support the rear axle carrier sub-assembly.

NOTICE:

- When jacking up the rear axle carrier sub-assembly, be sure to jack it up slowly.
- Make sure to perform this operation with the vehicle kept as low as possible.

(2) Loosen the bolt (A).

NOTICE:

Because the nut has its own stopper, do not turn the nut. Loosen the bolt with the nut secured.

(3) Remove the 2 bolts.

(4) Remove the nut and plate washer, and separate the rear shock absorber assembly from the rear axle carrier sub-assembly.

NOTICE:

Hold the rear axle carrier pin while rotating the nut.

(5) Remove the bolt (A), nut and rear axle carrier sub-assembly from the rear upper control arm assembly.

NOTICE:

- Because the nut has its own stopper, do not turn the nut. Loosen the bolt with the nut secured.
- Use wire or an equivalent tool to keep the rear drive shaft assembly from hanging down.

