

<b>Last Modified:</b> 12-04-2024	6.11:8.1.0	<b>Doc ID:</b> RM10000002BCSD
<b>Model Year Start:</b> 2023	<b>Model:</b> Prius Prime	<b>Prod Date Range:</b> [03/2023 - ]
<b>Title:</b> AXLE AND DIFFERENTIAL: REAR AXLE CARRIER (for 2WD): REMOVAL; 2023 - 2024 MY Prius Prius Prime [03/2023 - ]		

## REMOVAL

### CAUTION / NOTICE / HINT

The necessary procedures (adjustment, calibration, initialization, or registration) that must be performed after parts are removed and installed, or replaced during rear axle carrier sub-assembly removal/installation are shown below.

#### **Necessary Procedures After Parts Removed/Installed/Replaced**

REPLACED PART OR PERFORMED PROCEDURE	NECESSARY PROCEDURE	EFFECT/INOPERATIVE FUNCTION WHEN NECESSARY PROCEDURE NOT PERFORMED	LINK
Rear wheel alignment adjustment	Perform "Calibration"	<ul style="list-style-type: none"> <li>• DTCs are stored</li> <li>• ABS warning light illuminates</li> <li>• Brake system warning light (yellow indicator) illuminates</li> <li>• Slip indicator light illuminates</li> <li>• Electronically controlled brake system disabled or malfunctions</li> </ul>	<a href="#">INFO</a>
Tires	<ul style="list-style-type: none"> <li>• Initialization*1*2</li> <li>• Tire Position Identification*1*2</li> </ul>	Tire Pressure Warning System	Refer to Procedures Necessary When Replacing Parts (for Tire Pressure Warning System) <a href="#">INFO</a>
	Rear television camera assembly optical axis (Back camera position setting)*3	Parking Assist Monitor System	<a href="#">INFO</a>
	Parking assist ECU initialization*3	Panoramic View Monitor System	<a href="#">INFO</a>
Advanced Park		<a href="#">INFO</a>	
Suspension parts	Rear television camera assembly optical axis (Back camera position	Parking Assist Monitor System	<a href="#">INFO</a>

\*1: Also necessary after performing a tire rotation.

\*2: It is not necessary to perform this procedure if the tire pressure warning valve and transmitters are installed to the same location.

\*3: The vehicle height changes because of suspension or tire replacement.

REPLACED PART OR PERFORMED PROCEDURE	NECESSARY PROCEDURE	EFFECT/INOPERATIVE FUNCTION WHEN NECESSARY PROCEDURE NOT PERFORMED	LINK
	setting)		
	Parking assist ECU initialization	Panoramic View Monitor System	<a href="#">INFO</a>
		Advanced Park	<a href="#">INFO</a>
<p>*1: Also necessary after performing a tire rotation.</p> <p>*2: It is not necessary to perform this procedure if the tire pressure warning valve and transmitters are installed to the same location.</p> <p>*3: The vehicle height changes because of suspension or tire replacement.</p>			

**HINT:**

When the cable is disconnected / reconnected to the auxiliary battery terminal, systems temporarily stop operating. However, each system has a function that completes learning the first time the system is used.

**Learning completes when vehicle is driven**

EFFECT/INOPERATIVE FUNCTION WHEN NECESSARY PROCEDURE NOT PERFORMED	NECESSARY PROCEDURE	LINK
Front Camera System	Drive the vehicle straight ahead at 35 km/h (22 mph) or more for 5 second or more.	<a href="#">INFO</a>

**Learning completes when vehicle is operated normally**

EFFECT/INOPERATIVE FUNCTION WHEN NECESSARY PROCEDURE NOT PERFORMED	NECESSARY PROCEDURE	LINK
Power Door Lock Control System*1 • <a href="#">Back door opener</a>	Perform door unlock operation with door control switch or electrical key transmitter sub-assembly switch.	<a href="#">INFO</a>
Power Back Door System*2	Reset back door close position	<a href="#">INFO</a>
Air Conditioning System	<p><b>for HEV Model:</b></p> <p>After the ignition switch is turned to ON, the servo motor standard position is recognized.</p> <p><b>for PHEV Model:</b></p> <p>After the ignition switch is turned to ON, the servo motor and expansion valve standard position is recognized.</p>	-
<p>*1: w/o Power Back Door System</p> <p>*2: w/ Power Back Door System</p>		

**CAUTION / NOTICE / HINT****NOTICE:**

- When the brake pedal is first depressed after replacing the brake pads or pushing back the disc brake piston, DTCs may be stored. As there is no malfunction, clear the DTC.
- While the auxiliary battery is connected, even if the ignition switch is off, the brake control system activates when the brake pedal is depressed or any door courtesy switch turns on. Therefore, when servicing the brake system components, do not operate the brake pedal or open/close the doors while the auxiliary battery is connected.

## CAUTION / NOTICE / HINT

### HINT:

- Use the same procedure for the RH and LH sides.
- The following procedure is for the LH side.

## CAUTION / NOTICE / HINT

### COMPONENTS (REMOVAL)

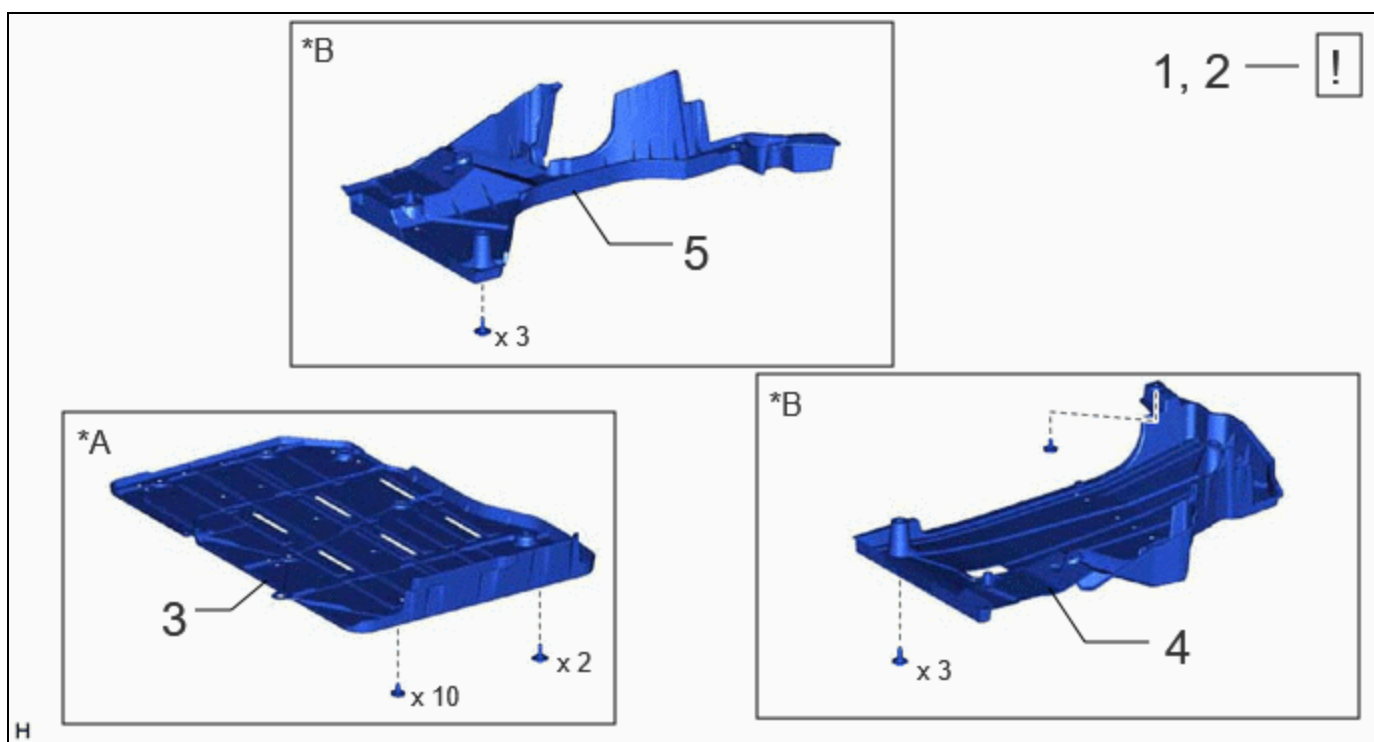

PROCEDURE		PART NAME CODE			
1	PRECAUTION	-	INFO	-	-
2	DISABLE BRAKE CONTROL	-	INFO	-	-
3	BATTERY BOX COVER	58219K	-	-	-
4	REAR FLOOR SIDE MEMBER COVER LH	57628E	-	-	-
5	REAR FLOOR SIDE MEMBER COVER RH	57627G	-	-	-

*A	for PHEV Model	*B	for HEV Model
----	----------------	----	---------------

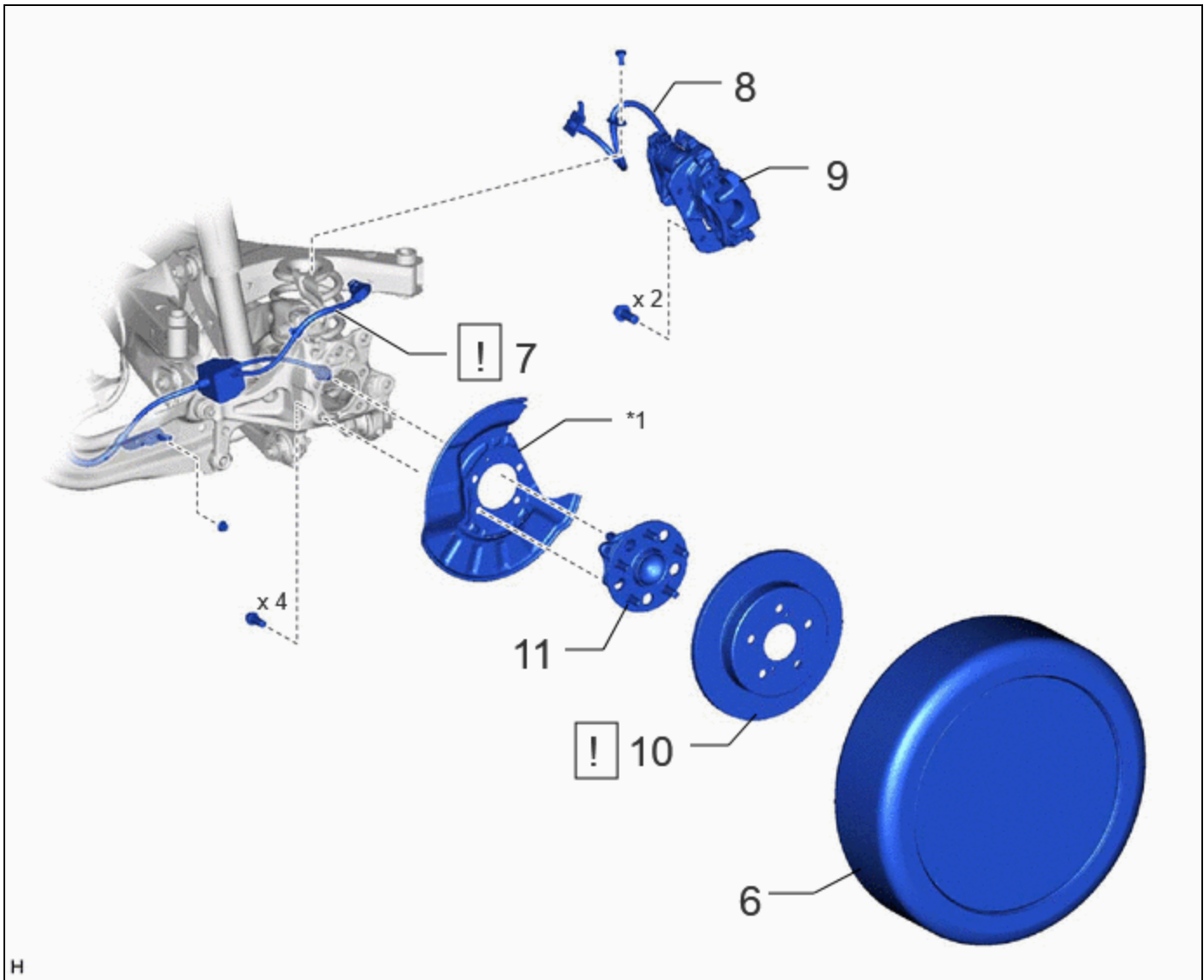

PROCEDURE		PART NAME CODE			
6	REAR WHEEL	-	-	-	-
7	NO. 2 PARKING BRAKE WIRE ASSEMBLY	890C0A	<a href="#">INFO</a>	-	-
8	REAR FLEXIBLE HOSE	47319F	-	-	-
9	REAR DISC BRAKE CALIPER ASSEMBLY	-	-	-	-
10	REAR DISC	42431	<a href="#">INFO</a>	-	-
11	REAR AXLE HUB AND BEARING ASSEMBLY	42450B	-	-	-

*1	REAR DISC BRAKE DUST COVER SUB-ASSEMBLY	-	-
----	---	---	---

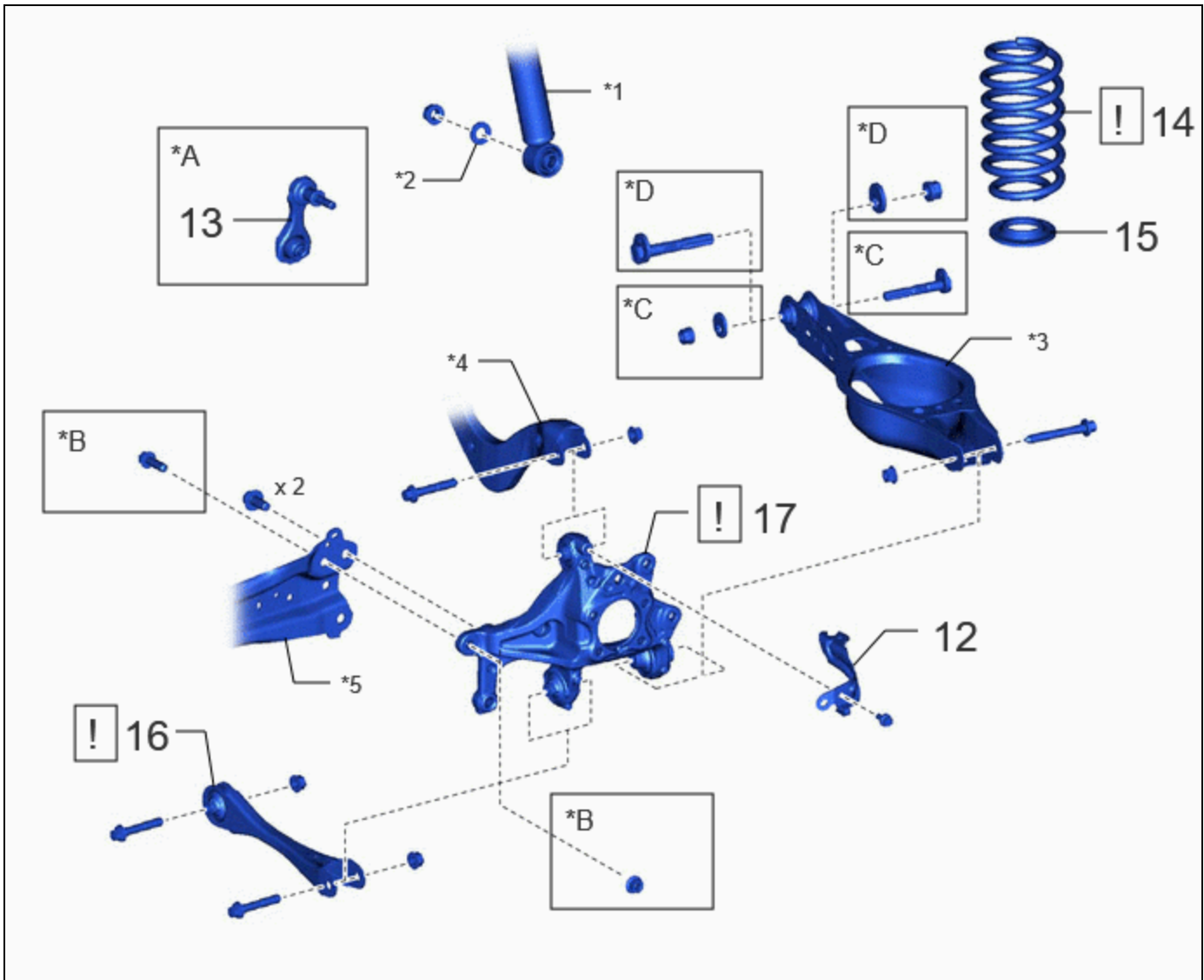

PROCEDURE		PART NAME CODE	!		
12	NO. 4 FLEXIBLE HOSE BRACKET	47354B	-	-	-
13	REAR STABILIZER LINK ASSEMBLY	48840A	-	-	-
14	REAR COIL SPRING	48231B	INFO	-	-
15	REAR LOWER COIL SPRING INSULATOR	48258C	-	-	-
16	REAR NO. 1 SUSPENSION ARM ASSEMBLY	48720A	INFO	-	-
17	REAR AXLE CARRIER SUB-ASSEMBLY	42305	INFO	-	-

*A	w/ Stabilizer Bar	*B	w/o Stabilizer Bar
*C	for HEV Model	*D	for PHEV Model
*1	REAR SHOCK ABSORBER ASSEMBLY	*2	PLATE WASHER
*3	REAR NO. 2 SUSPENSION ARM ASSEMBLY	*4	REAR UPPER CONTROL ARM ASSEMBLY

*5	REAR TRAILING ARM ASSEMBLY	-	-
----	----------------------------	---	---

## **PROCEDURE**

### **1. PRECAUTION**

	<p><b>NOTICE:</b></p> <p>After the ignition switch is turned off, there may be a waiting time before disconnecting the negative (-) auxiliary battery terminal.</p> <p>Click here <a href="#">INFO</a></p>
---	--

### **2. DISABLE BRAKE CONTROL**

	<p>Click here <a href="#">INFO</a></p>
---	--

### **3. REMOVE BATTERY BOX COVER (for PHEV Model)**

Click here [INFO](#)

### **4. REMOVE REAR FLOOR SIDE MEMBER COVER LH (for HEV Model)**

Click here [INFO](#)

### **5. REMOVE REAR FLOOR SIDE MEMBER COVER RH (for HEV Model)**

Click here [INFO](#)

### **6. REMOVE REAR WHEEL**

Click here [INFO](#)

### **7. SEPARATE NO. 2 PARKING BRAKE WIRE ASSEMBLY**

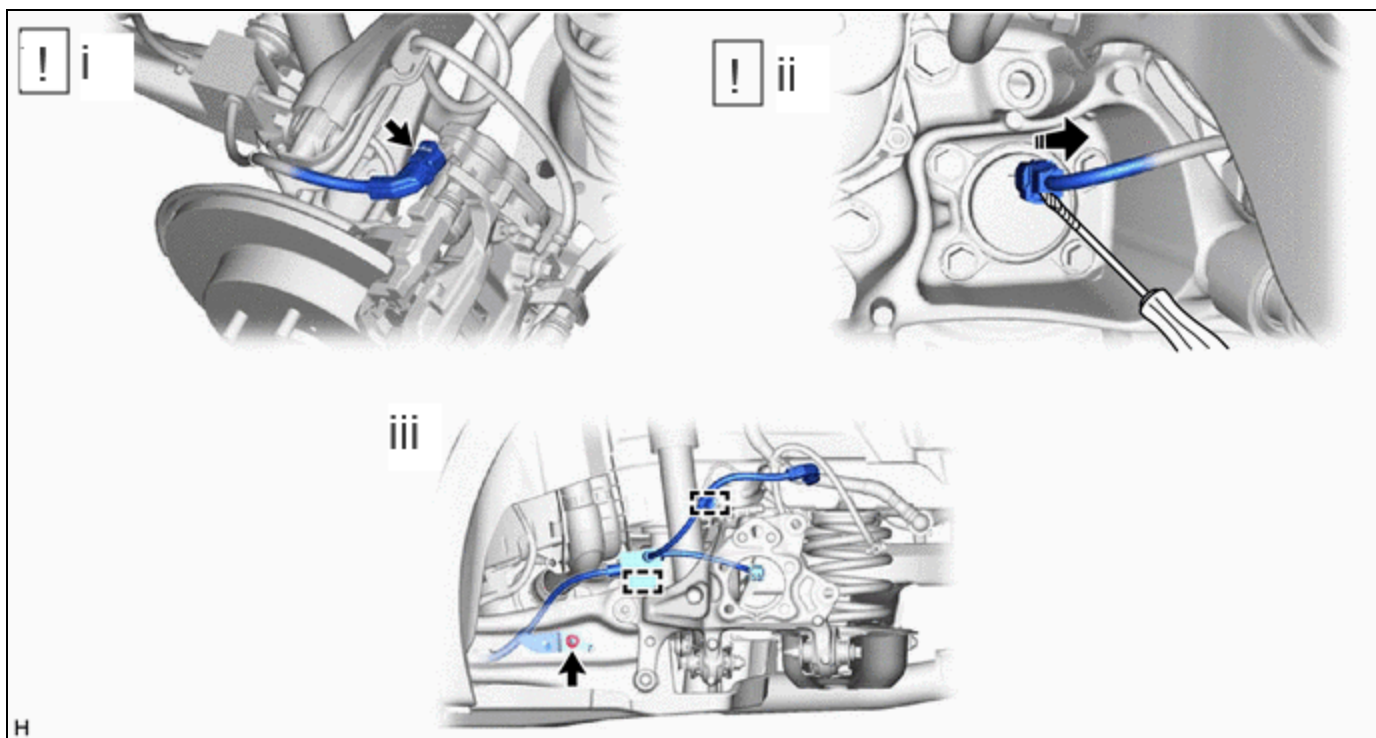

(1) Disconnect the No. 2 parking brake wire assembly connector from the parking brake actuator assembly.

**NOTICE:**

- Remove any dirt or foreign matter on and around the No. 2 parking brake wire assembly connector before performing this step.
- Do not allow water, oil or dirt to enter the No. 2 parking brake wire assembly connector.

(2) Using a screwdriver with its tip wrapped in protective tape, disconnect the No. 2 parking brake wire assembly connector from the rear axle hub and bearing assembly.

**NOTICE:**

Be careful not to damage the rear axle hub and bearing assembly and connector cover.

(3) Remove the nut, disengage the 2 clamps and separate the No. 2 parking brake wire assembly from the rear flexible hose bracket and rear trailing arm assembly.

## 8. SEPARATE REAR FLEXIBLE HOSE

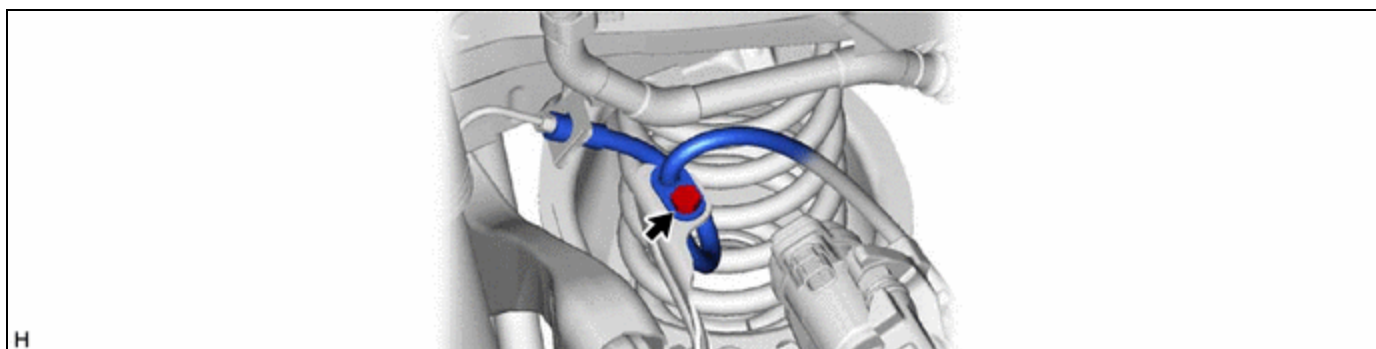

## 9. SEPARATE REAR DISC BRAKE CALIPER ASSEMBLY

Click here [INFO](#)

## 10. REMOVE REAR DISC

	Click here <a href="#">INFO</a>
---	---------------------------------

**11. REMOVE REAR AXLE HUB AND BEARING ASSEMBLY**

Click here [INFO](#)

**12. REMOVE NO. 4 FLEXIBLE HOSE BRACKET**

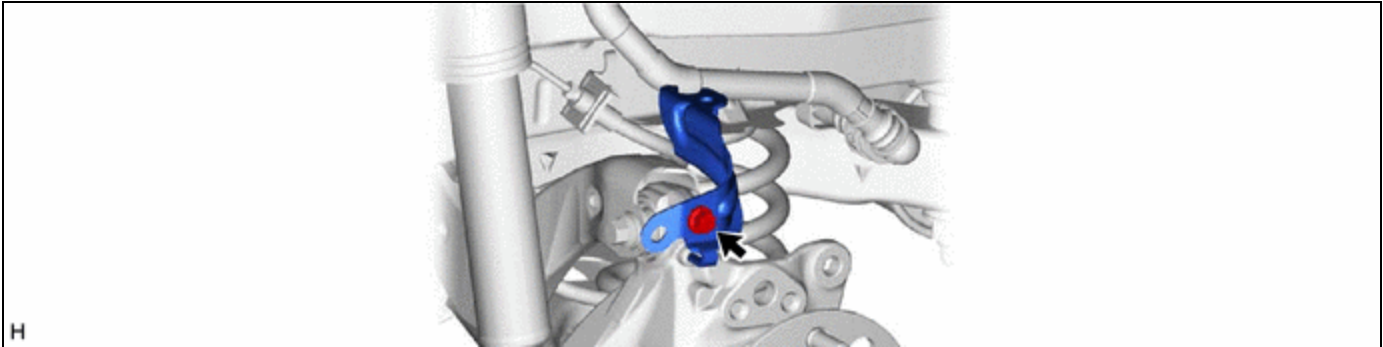

**13. REMOVE REAR STABILIZER LINK ASSEMBLY (w/ Stabilizer Bar)**

Click here [INFO](#)

**14. REMOVE REAR COIL SPRING**

	Click here <a href="#">INFO</a>
---	---------------------------------

**15. REMOVE REAR LOWER COIL SPRING INSULATOR**

Click here [INFO](#)

**16. REMOVE REAR NO. 1 SUSPENSION ARM ASSEMBLY**

	for HEV Model: Click here <a href="#">INFO</a> for PHEV Model: Click here <a href="#">INFO</a>
---	---

**17. REMOVE REAR AXLE CARRIER SUB-ASSEMBLY**



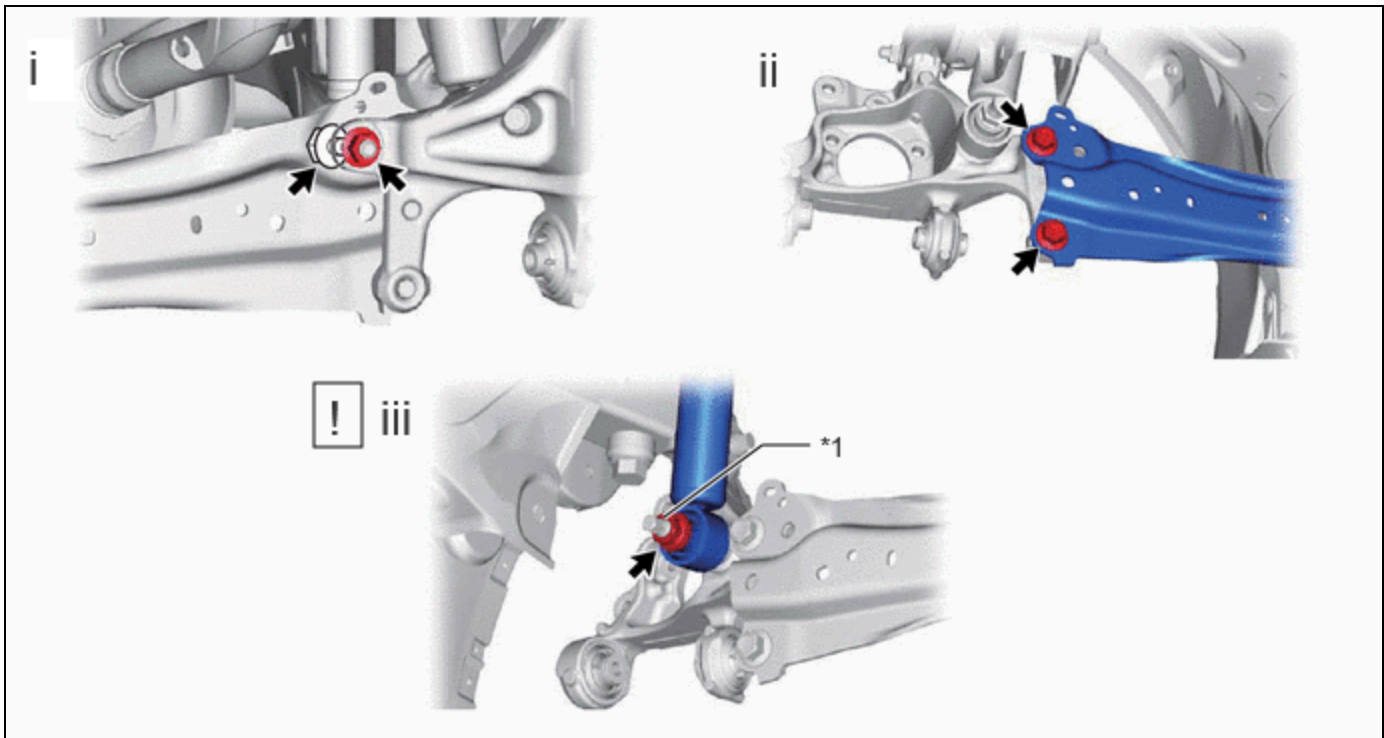

*1	Rear Axle Carrier Pin	-	-
----	-----------------------	---	---

(1) w/o Stabilizer Bar:

1. Loosen the bolt and nut.
- (2) Loosen the 2 bolts.
- (3) Loosen the nut of the rear shock absorber assembly.

**NOTICE:**

Hold the rear axle carrier pin while rotating the nut.

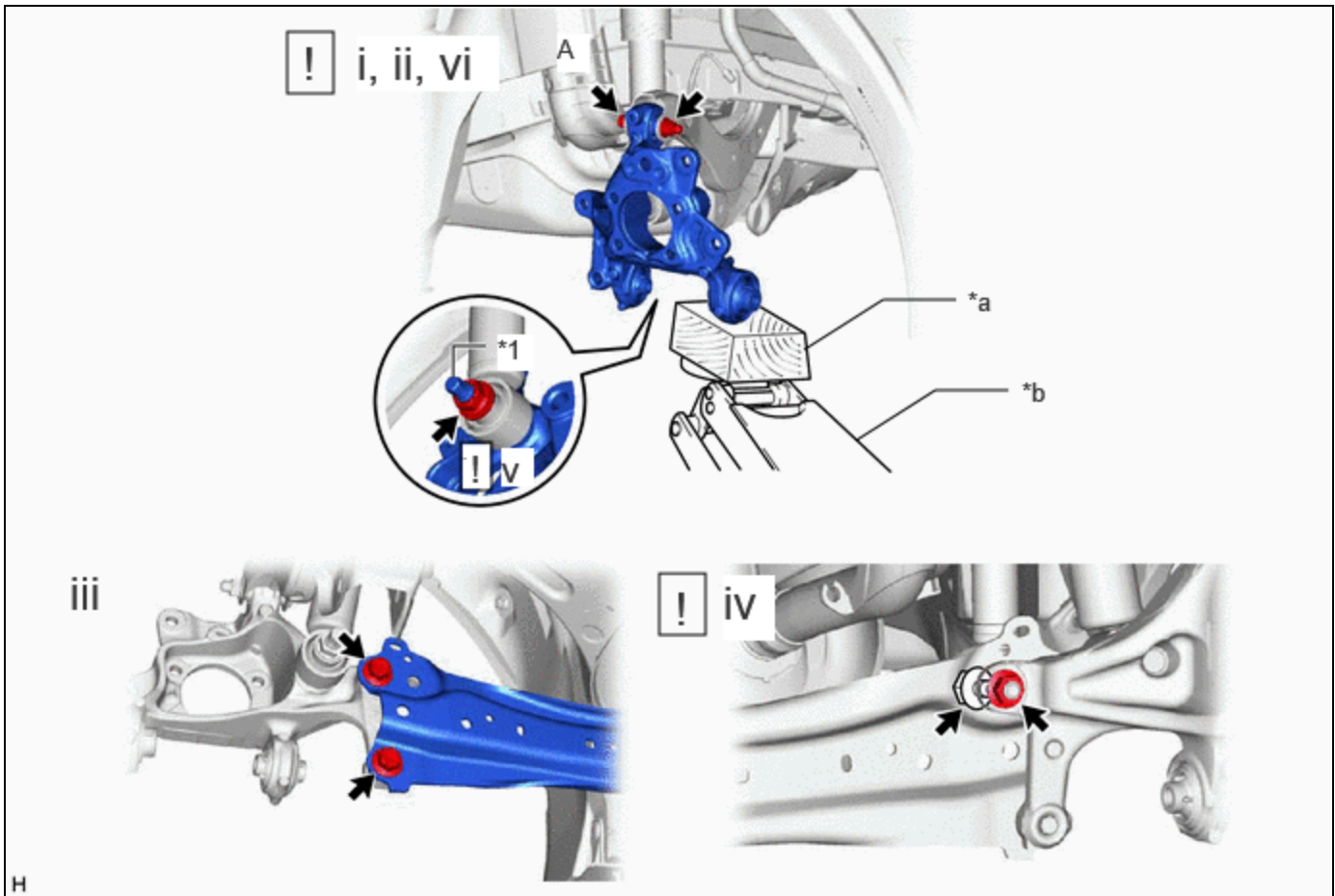

*1	Rear Axle Carrier Pin	-	-
*a	Wooden Block	*b	Jack

(1) Using a jack and wooden block, support the rear axle carrier sub-assembly.

**NOTICE:**

- When jacking up the rear axle carrier sub-assembly, be sure to jack it up slowly.
- Make sure to perform this operation with the vehicle kept as low as possible.

(2) Loosen the bolt (A).

**NOTICE:**

Because the nut has its own stopper, do not turn the nut. Loosen the bolt with the nut secured.

(3) Remove the 2 bolts.

(4) w/o Stabilizer Bar:

1. Remove the bolt and nut.

(5) Remove the nut and plate washer, and separate the rear shock absorber assembly from the rear axle carrier sub-assembly.

**NOTICE:**

Hold the rear axle carrier pin while rotating the nut.

(6) Remove the bolt (A), nut and rear axle carrier sub-assembly from the rear upper control arm assembly.

**NOTICE:**

Because the nut has its own stopper, do not turn the nut. Loosen the bolt with the nut secured.

