

Last Modified: 12-04-2024	6.11:8.1.0	Doc ID: RM100000002A06U
Model Year Start: 2023	Model: Prius	Prod Date Range: [12/2022 -]
Title: PA10/PB10/PB12 (HYBRID TRANSMISSION / TRANSAXLE): PA10 HYBRID VEHICLE TRANSAXLE: REMOVAL; 2023 - 2024 MY Prius [12/2022 -]		

REMOVAL

CAUTION / NOTICE / HINT

The necessary procedures (adjustment, calibration, initialization or registration) that must be performed after parts are removed and installed, or replaced during hybrid vehicle transaxle assembly removal/installation are shown below.

Necessary Procedures After Parts Removed/Installed/Replaced

REPLACED PART OR PERFORMED PROCEDURE	NECESSARY PROCEDURE	EFFECT/INOPERATIVE FUNCTION WHEN NECESSARY PROCEDURE NOT PERFORMED	LINK
Replacement of ECM	Update ECU security key	Vehicle Control History (RoB) are stored	INFO
	ECU configuration	-	INFO
	Perform Vehicle Identification Number (VIN) registration	DTC is output	INFO
Replacement of inverter with converter assembly	ECU configuration	-	INFO
	Resolver learning	<ul style="list-style-type: none"> DTCs are stored Slight vibration at a vehicle speed of 5 km/h (3 mph) or less Shock or vibration during acceleration 	INFO
Replacement of hybrid vehicle transaxle assembly	<ul style="list-style-type: none"> Resolver learning Initialize resolver 	<ul style="list-style-type: none"> DTCs are stored Slight vibration at a vehicle speed of 5 km/h (3 mph) or less 	INFO

*1: Also necessary after performing a tire rotation.

*2: It is not necessary to perform this procedure if the tire pressure warning valve and transmitters are installed to the same location.

*3: Even when not replacing the part, it is necessary to perform the specified necessary procedures after installation.

*4: The vehicle height changes because of tire replacement.

*5: If matchmarks were not placed when removing parts related to steering operation, perform end position initial setting.

REPLACED PART OR PERFORMED PROCEDURE	NECESSARY PROCEDURE	EFFECT/INOPERATIVE FUNCTION WHEN NECESSARY PROCEDURE NOT PERFORMED	LINK
		<ul style="list-style-type: none"> Shock or vibration during acceleration 	
<ul style="list-style-type: none"> Replacement of throttle body assembly Replacement of engine assembly Gas leak from exhaust system is repaired 	Inspection after repair	<ul style="list-style-type: none"> Poor idle, etc. Engine start function, etc. 	INFO
Suspension parts	Rear television camera assembly optical axis (Back camera position setting)	Parking Assist Monitor System	INFO
	Parking assist ECU initialization	Panoramic View Monitor System	INFO
		Advanced Park	INFO
Front wheel alignment adjustment	Perform "Calibration"	<ul style="list-style-type: none"> DTCs are stored ABS warning light illuminates Brake system warning light (yellow indicator) illuminates Slip indicator light illuminates Electronically controlled brake system disabled or malfunctions 	INFO
Tires	<ul style="list-style-type: none"> Initialization*1*2 Tire Position Identification*1*2 	Tire Pressure Warning System	Refer to Procedures Necessary When Replacing Parts (for Tire Pressure
<p>*1: Also necessary after performing a tire rotation.</p> <p>*2: It is not necessary to perform this procedure if the tire pressure warning valve and transmitters are installed to the same location.</p> <p>*3: Even when not replacing the part, it is necessary to perform the specified necessary procedures after installation.</p> <p>*4: The vehicle height changes because of tire replacement.</p> <p>*5: If matchmarks were not placed when removing parts related to steering operation, perform end position initial setting.</p>			

REPLACED PART OR PERFORMED PROCEDURE	NECESSARY PROCEDURE	EFFECT/INOPERATIVE FUNCTION WHEN NECESSARY PROCEDURE NOT PERFORMED	LINK
			Warning System) table below INFO
	Rear television camera assembly optical axis (Back camera position setting)*4	Parking Assist Monitor System	INFO
	Parking assist ECU initialization*4	Panoramic View Monitor System	INFO
Advanced Park		INFO	
Replacement of front bumper assembly*3	Front television camera view adjustment	Panoramic View Monitor System	INFO
		Advanced Park	INFO
No. 2 steering intermediate shaft assembly*5	End position initial setting	-	INFO

*1: Also necessary after performing a tire rotation.

*2: It is not necessary to perform this procedure if the tire pressure warning valve and transmitters are installed to the same location.

*3: Even when not replacing the part, it is necessary to perform the specified necessary procedures after installation.

*4: The vehicle height changes because of tire replacement.

*5: If matchmarks were not placed when removing parts related to steering operation, perform end position initial setting.

CAUTION:

- Orange wire harnesses and connectors indicate high-voltage circuits. To prevent electric shock, always follow



the procedure described in the repair manual.

[Click here](#) **INFO**

- To prevent electric shock, wear insulated gloves when working on wire harnesses and components of the high



voltage system.

- To prevent burns, do not touch the engine, exhaust manifold or other high temperature components while the



engine is hot.

- The engine assembly with transaxle is very heavy. Be sure to follow the procedure described in the repair manual, or the engine lifter may suddenly drop or the engine assembly with transaxle may fall off the engine

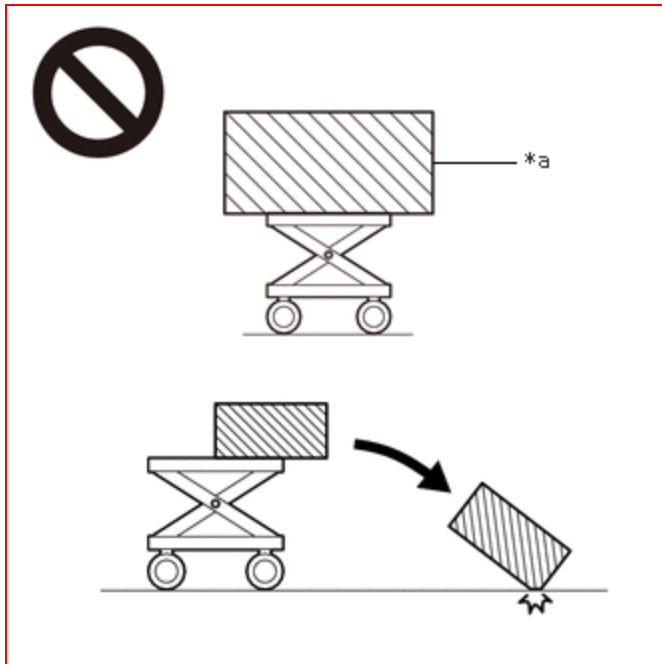

lifter.

*a	An Object Exceeding Weight Limit of Engine Lifter
----	---

HINT:

When the cable is disconnected / reconnected to the auxiliary battery terminal, systems temporarily stop operating. However, each system has a function that completes learning the first time the system is used.

Learning completes when vehicle is driven

EFFECT/INOPERATIVE FUNCTION WHEN NECESSARY PROCEDURE NOT PERFORMED	NECESSARY PROCEDURE	LINK
Front Camera System	Drive the vehicle straight ahead at 35 km/h (22 mph) or more for 5 seconds or more.	INFO



Learning completes when vehicle is operated normally

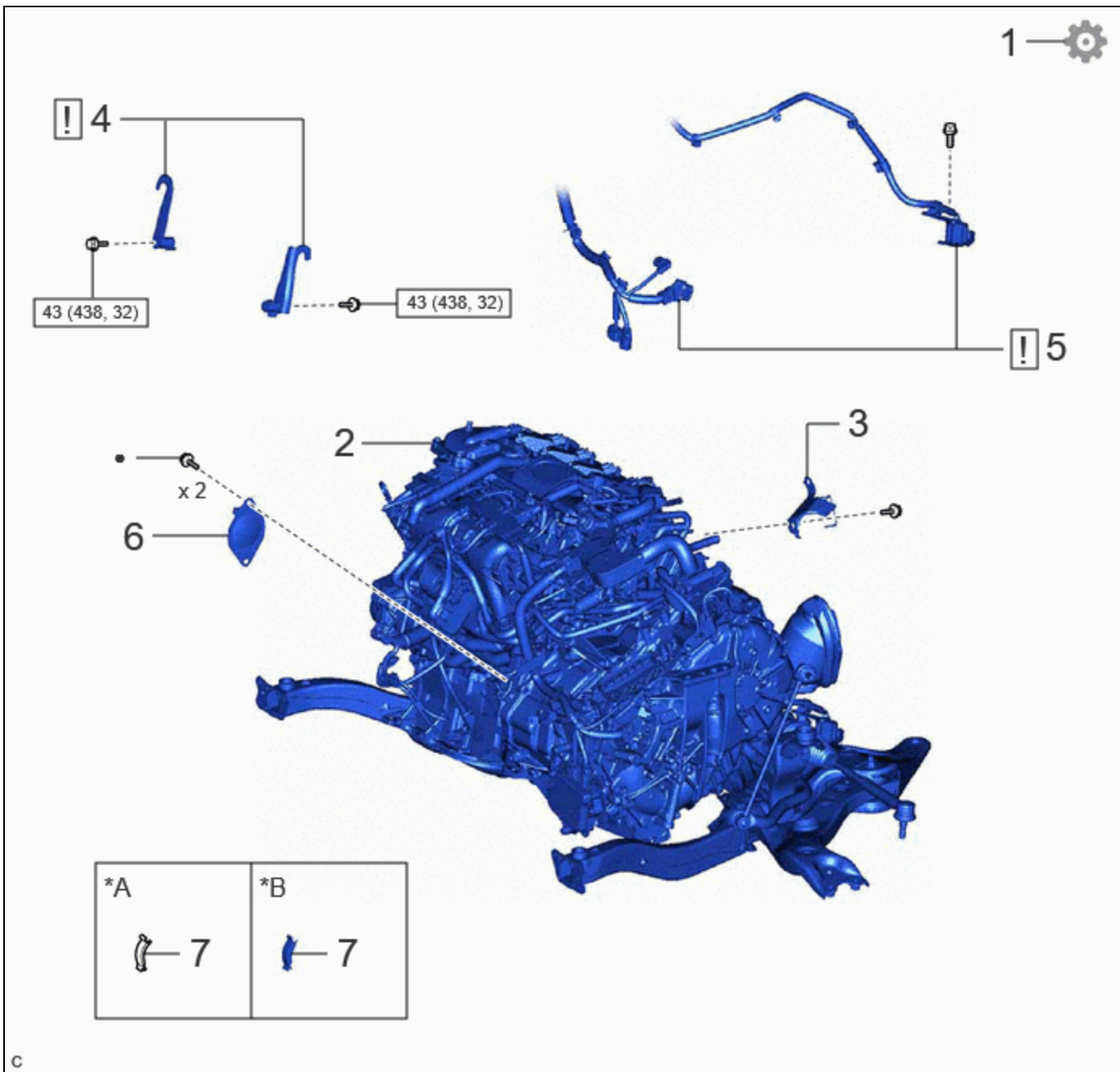

EFFECT/INOPERATIVE FUNCTION WHEN NECESSARY PROCEDURE NOT PERFORMED	NECESSARY PROCEDURE	LINK
Power Door Lock Control System*1 <ul style="list-style-type: none"> • Back door opener 	Perform door unlock operation with door control switch or electrical key transmitter sub-assembly switch.	INFO
Power Back Door System*2	Reset back door close position	INFO
Air Conditioning System	After the ignition switch is turned to ON, the servo motor standard position is recognized.	-
*1: w/o Power Back Door System *2: w/ Power Back Door System		

CAUTION / NOTICE / HINT





COMPONENTS (REMOVAL)



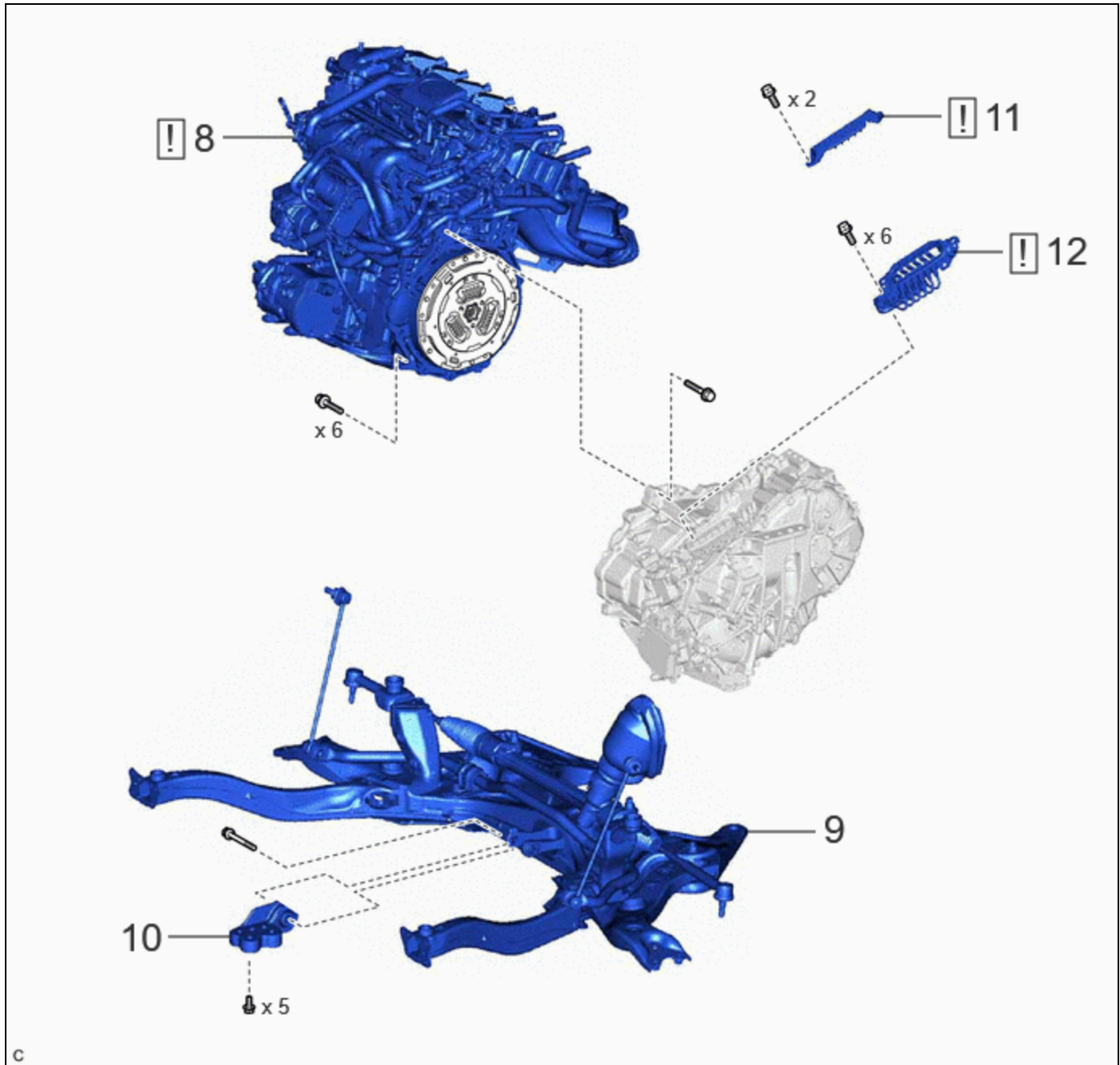



	PROCEDURE	PART NAME CODE			
1	PERFORM RESOLVER INITIALIZATION	-	-	-	INFO
2	ENGINE ASSEMBLY WITH TRANSAXLE	-	-	-	-
3	WIRE HARNESS CLAMP BRACKET	-	-	-	-
4	ENGINE HANGERS	-	INFO	-	-
5	ENGINE WIRE	82121	INFO	-	-
6	STARTER HOLE INSULATOR	28193	-	-	-
7	FLYWHEEL HOUSING SIDE COVER	11363A	-	-	-





*A	Type A	*B	Type B
	N*m (kgf*cm, ft.*lbf): Specified torque		Non-reusable part

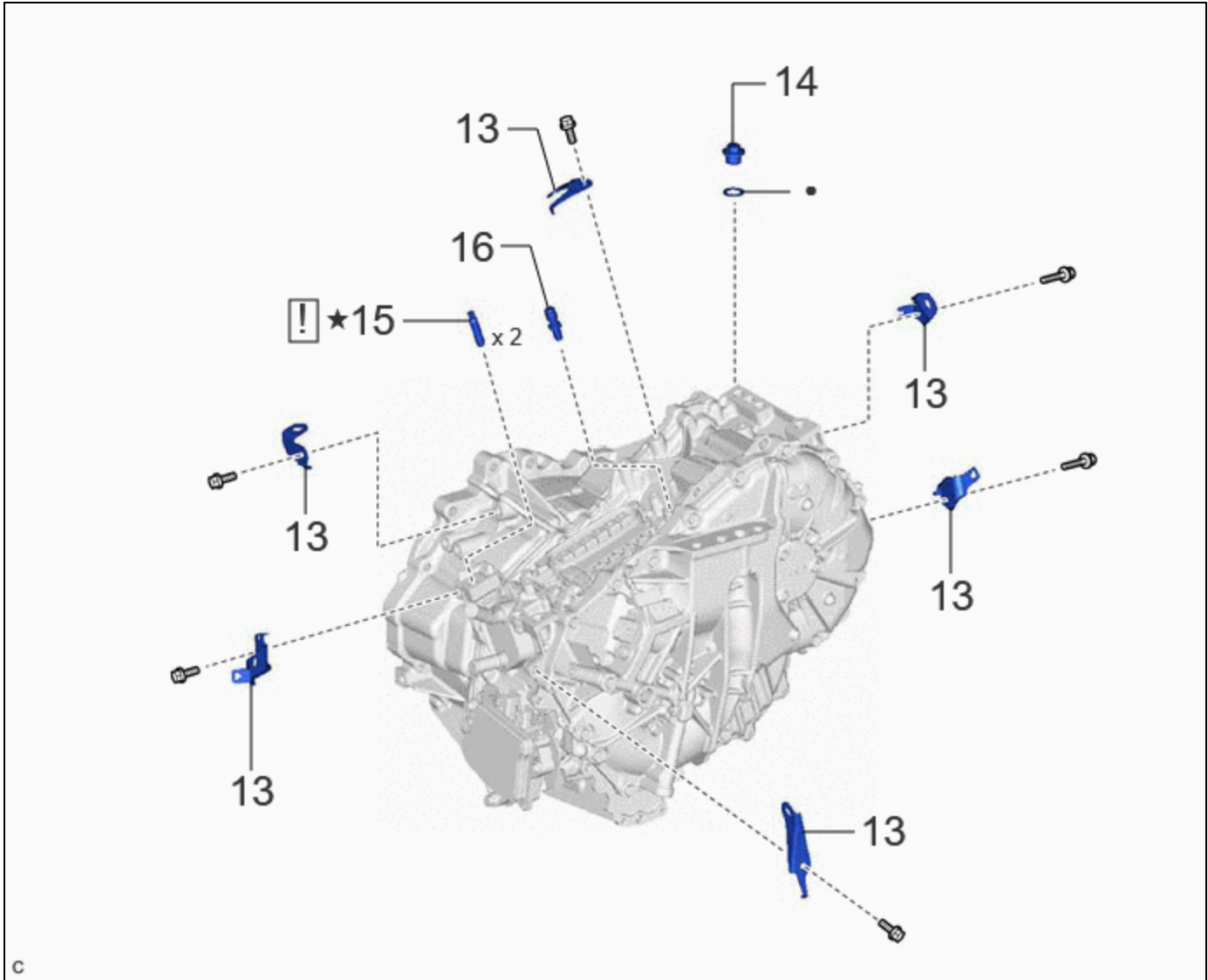

PROCEDURE		PART NAME CODE			
8	ENGINE ASSEMBLY	-		-	-
9	FRONT SUSPENSION CROSSMEMBER SUB-ASSEMBLY	51201	-	-	-
10	NO. 2 ENGINE MOVING CONTROL ROD	12364B	-	-	-

PROCEDURE		PART NAME CODE			
11	TERMINAL CAP	82823M		-	-
12	MOTOR CABLE	G1148		-	-



PROCEDURE		PART NAME CODE			
13	WIRE HARNESS CLAMP BRACKET	-	-	-	-
14	TRANSAXLE HOUSING PLUG	-	-	-	-
15	STUD BOLT	-		-	-
16	TRANSAXLE BREATHER PLUG	30900N	-	-	-

	Non-reusable part		Precoated part
---	-------------------	---	----------------

PROCEDURE

1. PERFORM RESOLVER INITIALIZATION

**NOTICE:**

If it is necessary to replace the hybrid vehicle transaxle assembly, make sure to perform resolver initialization before starting work.

Click here [INFO](#)

2. REMOVE ENGINE ASSEMBLY WITH TRANSAXLE

Click here [INFO](#)

3. REMOVE WIRE HARNESS CLAMP BRACKET

Click here [INFO](#)

4. INSTALL ENGINE HANGERS



Click here [INFO](#)

5. DISCONNECT ENGINE WIRE

**NOTICE:**

Cover the hole where the shift control actuator assembly was installed with tape or equivalent (non-residue type) to prevent entry of foreign matter, water, etc.

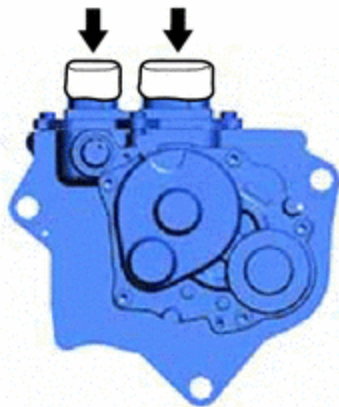

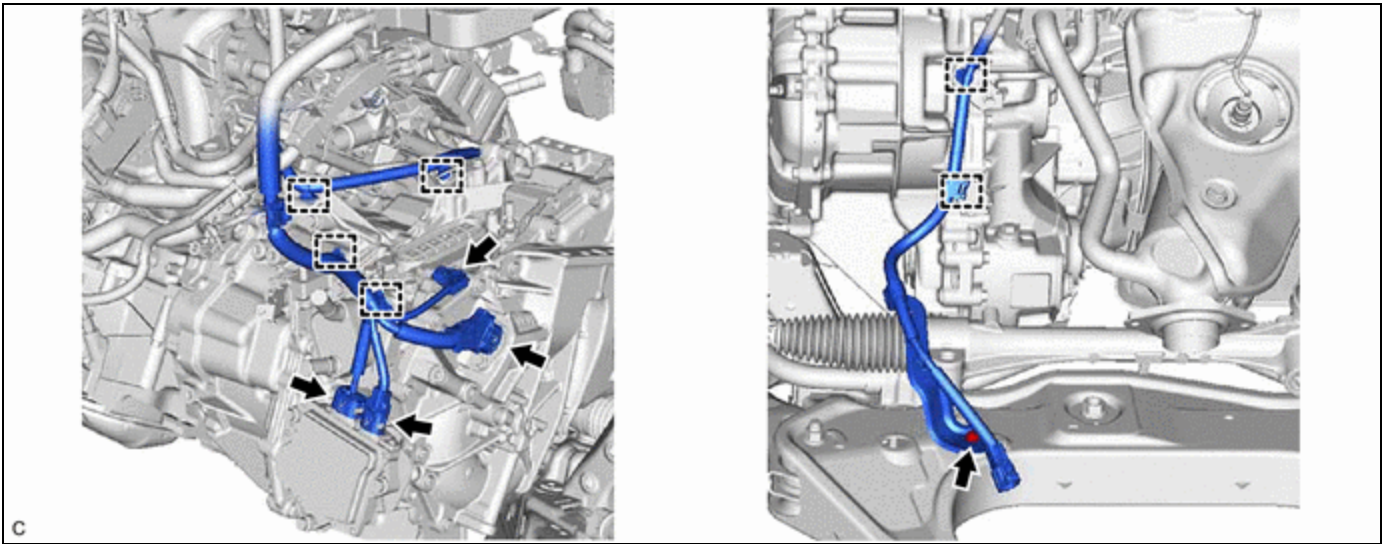

6. REMOVE STARTER HOLE INSULATOR

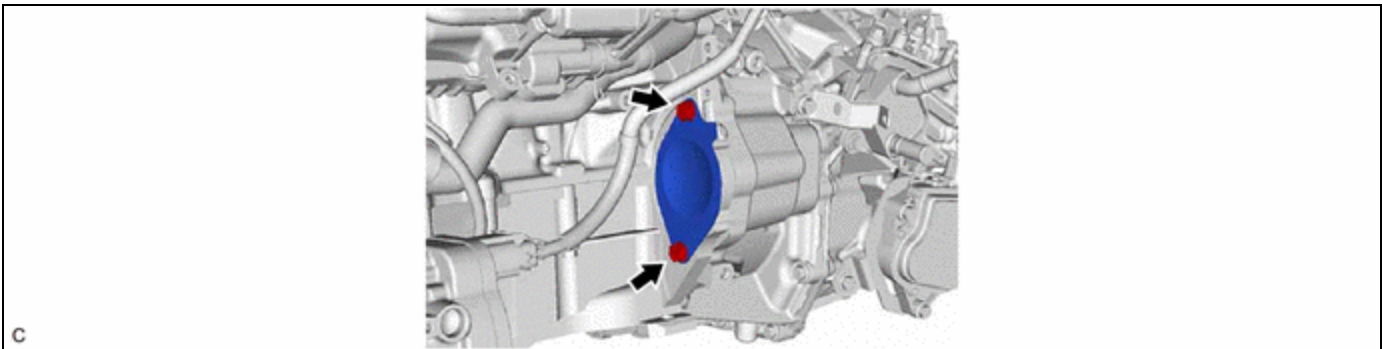

7. REMOVE FLYWHEEL HOUSING SIDE COVER

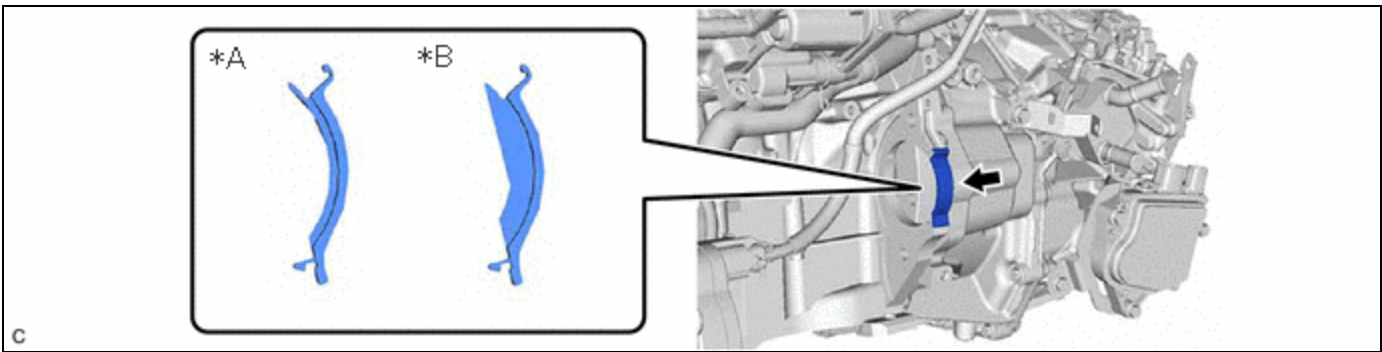

*A	Type A	*B	Type B
----	--------	----	--------

8. REMOVE ENGINE ASSEMBLY

	<p>NOTICE:</p> <ul style="list-style-type: none"> To avoid damaging the knock pins, do not pry between the hybrid vehicle transaxle assembly and engine assembly. To prevent the splines of the transmission input damper assembly from becoming misaligned, do not allow the hybrid vehicle transaxle assembly to hit the transmission input damper assembly during engine assembly removal and installation.
--	---

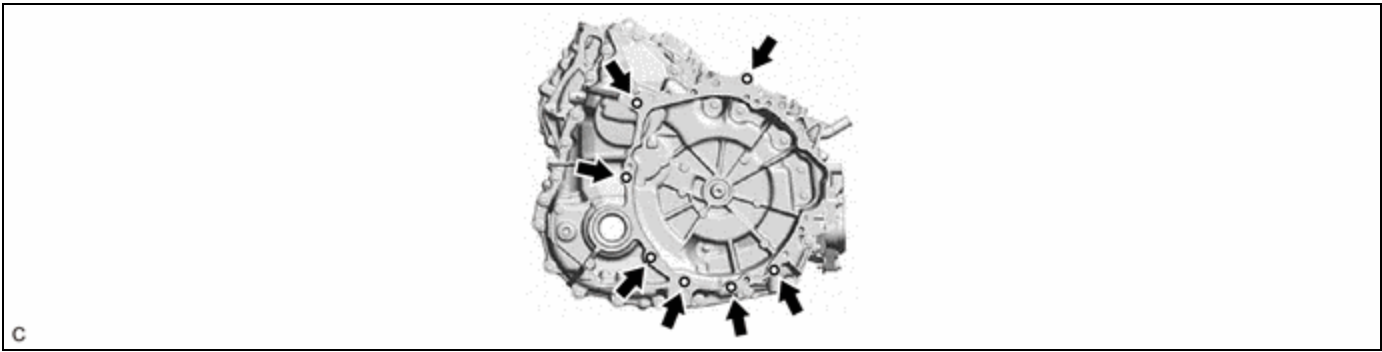

9. REMOVE FRONT SUSPENSION CROSSMEMBER SUB-ASSEMBLY

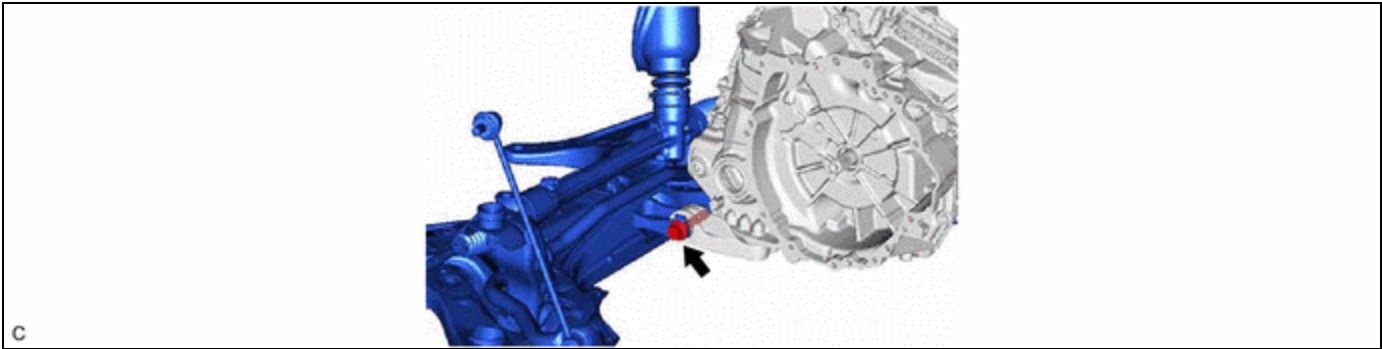

10. REMOVE NO. 2 ENGINE MOVING CONTROL ROD

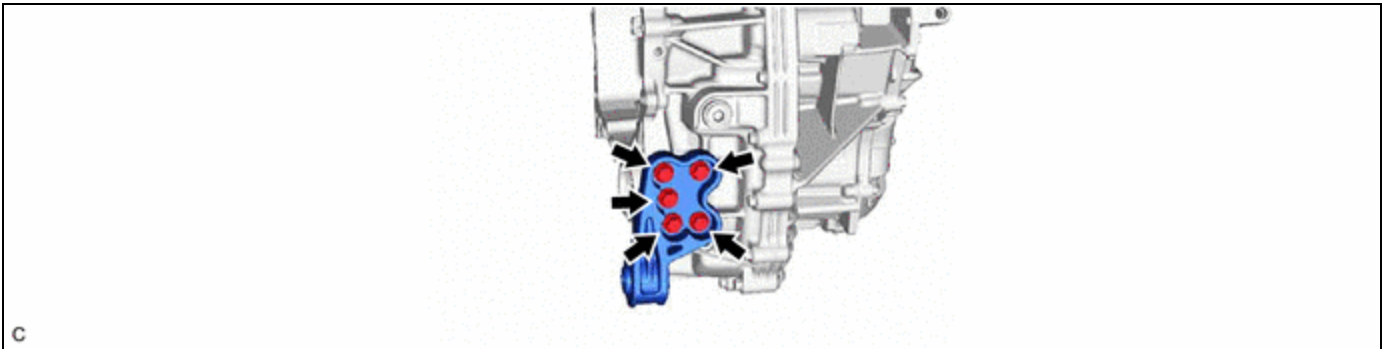

11. REMOVE TERMINAL CAP

	Click here INFO
---	---------------------------------

12. REMOVE MOTOR CABLE

	Click here INFO
---	---------------------------------

13. REMOVE WIRE HARNESS CLAMP BRACKET

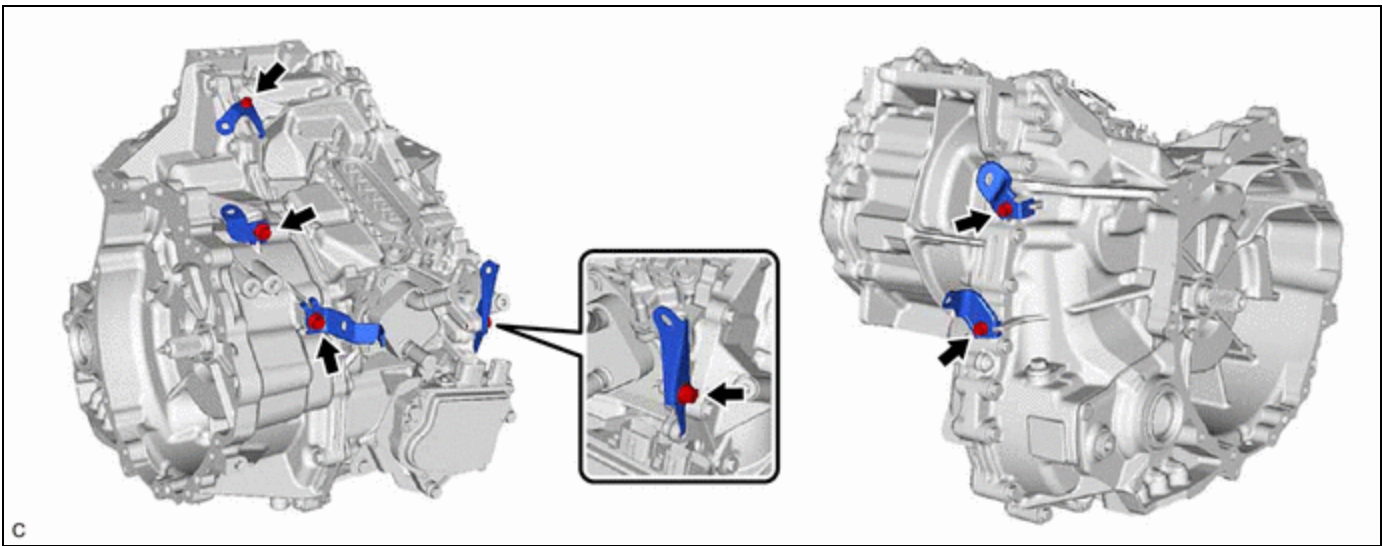

14. REMOVE TRANSAXLE HOUSING PLUG

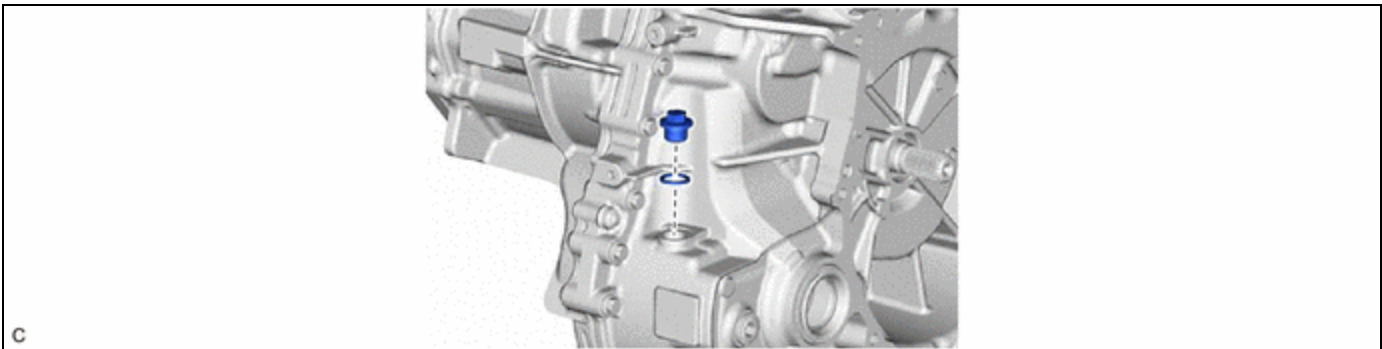

15. REMOVE STUD BOLT

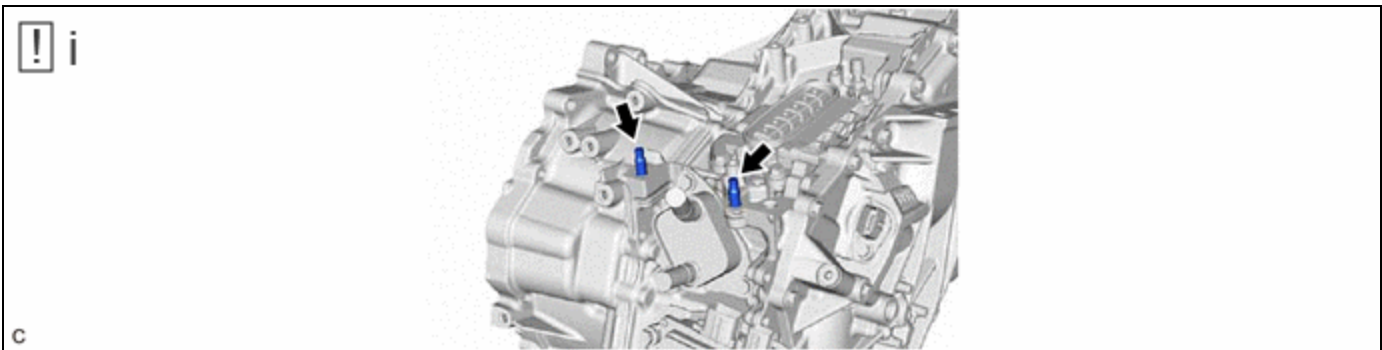

(1) Using an E10 "TORX" socket wrench, remove the 2 stud bolts from the hybrid vehicle transaxle assembly.

16. REMOVE TRANSAXLE BREATHER PLUG

HINT:

Perform this procedure only when replacement of the transaxle breather plug is necessary.

