

Last Modified: 12-04-2024	6.11:8.1.0	Doc ID: RM10000002AVGD
Model Year Start: 2023	Model: Prius Prime	Prod Date Range: [03/2023 -]
Title: BRAKE CONTROL / DYNAMIC CONTROL SYSTEMS: BRAKE ACTUATOR: REMOVAL; 2023 - 2024 MY Prius Prius Prime [03/2023 -]		

REMOVAL

CAUTION / NOTICE / HINT

The necessary procedures (adjustment, calibration, initialization or registration) that must be performed after parts are removed and installed, or replaced during brake actuator assembly removal/installation are shown below.

Necessary Procedures After Parts Removed/Installed/Replaced

REPLACED PART OR PERFORMED PROCEDURE	NECESSARY PROCEDURE	EFFECT/INOPERATIVE FUNCTION WHEN NECESSARY PROCEDURE NOT PERFORMED	LINK
No. 2 skid control ECU (brake actuator assembly)	Update ECU security key	Vehicle Control History (RoB) are stored	INFO
	<ul style="list-style-type: none"> Bleed air Perform "Calibration" 	<ul style="list-style-type: none"> DTCs are stored ABS warning light illuminates Brake system warning light (yellow indicator) illuminates Slip indicator light illuminates Electronically controlled brake system disabled or malfunctions 	Bleeding: INFO Calibration: INFO
	Operate the electric parking brake switch	Electric Parking Brake System	INFO
Tires	<ul style="list-style-type: none"> Initialization*1*2 Tire Position Identification*1*2 	Tire Pressure Warning System	Refer to Procedures Necessary When Replacing Parts (for Tire Pressure Warning System) INFO
	Rear television camera assembly optical axis (Back camera position setting)	Parking Assist Monitor System	INFO
	Parking assist ECU initialization	Panoramic View Monitor System	INFO

*1: Also necessary after performing a tire rotation.

*2: It is not necessary to perform this procedure if the tire pressure warning valve and transmitters are installed to the same location.

REPLACED PART OR PERFORMED PROCEDURE	NECESSARY PROCEDURE	EFFECT/INOPERATIVE FUNCTION WHEN NECESSARY PROCEDURE NOT PERFORMED	LINK
		Advanced Park	INFO
<p>*1: Also necessary after performing a tire rotation.</p> <p>*2: It is not necessary to perform this procedure if the tire pressure warning valve and transmitters are installed to the same location.</p>			

HINT:

When the cable is disconnected / reconnected to the auxiliary battery terminal, systems temporarily stop operating. However, each system has a function that completes learning the first time the system is used.

Learning completes when vehicle is driven

EFFECT/INOPERATIVE FUNCTION WHEN NECESSARY PROCEDURE NOT PERFORMED	NECESSARY PROCEDURE	LINK
Front Camera System <ul style="list-style-type: none"> Back door opener 	Drive the vehicle straight ahead at 35 km/h (22 mph) or more for 5 seconds or more.	INFO

Learning completes when vehicle is operated normally

EFFECT/INOPERATIVE FUNCTION WHEN NECESSARY PROCEDURE NOT PERFORMED	NECESSARY PROCEDURE	LINK
Power Door Lock Control System*1	Perform door unlock operation with door control switch or electrical key transmitter sub-assembly switch.	INFO
Power Back Door System*2	Reset back door close position	INFO
Air Conditioning System	<p>for HEV Model:</p> <p>After the ignition switch is turned to ON, the servo motor standard position is recognized.</p> <p>for PHEV Model:</p> <p>After the ignition switch is turned to ON, the servo motor and expansion valve standard position is recognized.</p>	-
<p>*1: w/o Power Back Door System</p> <p>*2: w/ Power Back Door System</p>		

CAUTION / NOTICE / HINT**NOTICE:**

- After the ignition switch is turned off, the radio and display receiver assembly records various types of memory and settings. As a result, after turning the ignition switch off, make sure to wait at least 3 minutes before disconnecting the cable from the negative(-) auxiliary battery terminal.
- When the cable is disconnected from the negative (-) auxiliary battery terminal and the security lock setting has been enabled, multi-display operations will be disabled upon next startup unless the password is entered.

Be sure to check the security lock setting before disconnecting the cable from the negative (-) auxiliary battery terminal.

CAUTION / NOTICE / HINT

COMPONENTS (REMOVAL)

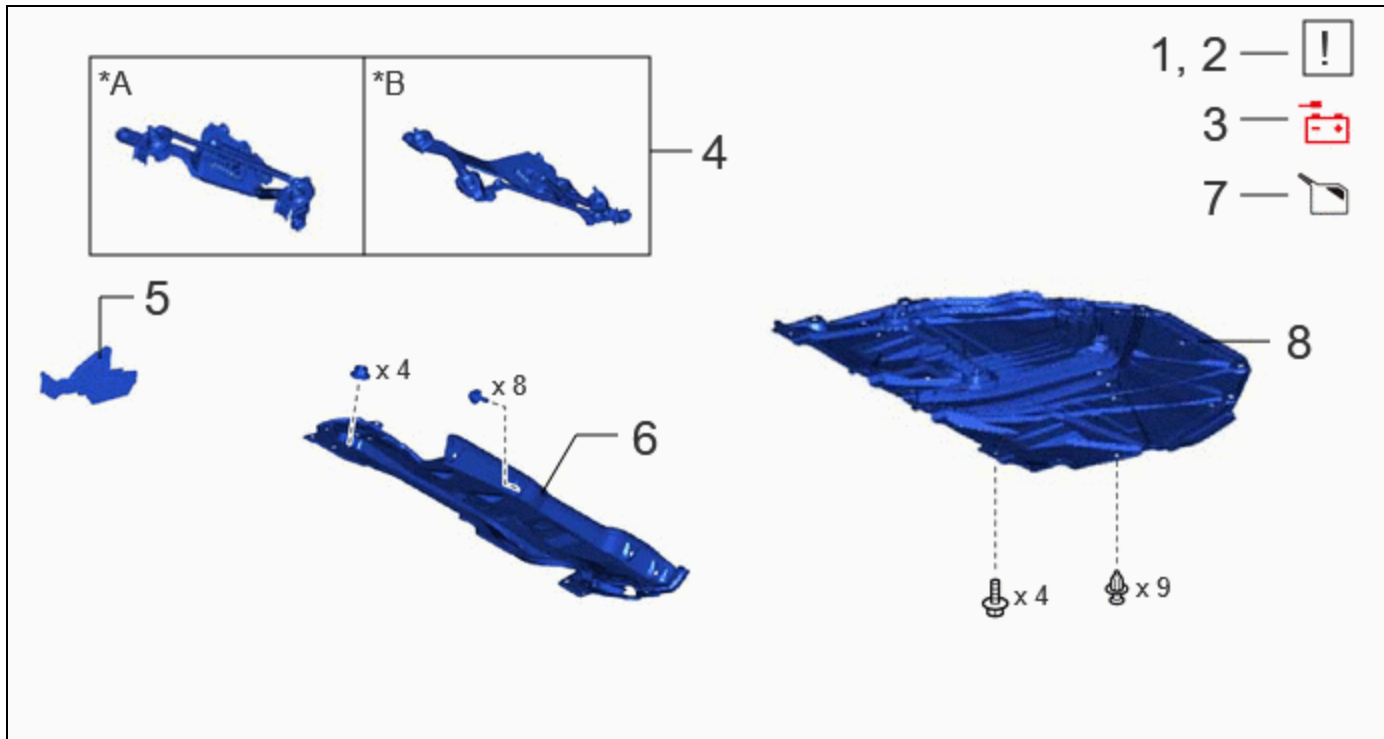

PROCEDURE		PART NAME CODE			
1	PRECAUTION	-	INFO	-	-
2	RECOVER REFRIGERANT FROM REFRIGERATION SYSTEM	-	INFO	-	-
3	DISCONNECT CABLE FROM NEGATIVE AUXILIARY BATTERY TERMINAL	-	-	-	-
4	WINDSHIELD WIPER MOTOR AND LINK	-	-	-	-
5	WATER GUARD PLATE	55734D	-	-	-
6	OUTER COWL TOP PANEL SUB-ASSEMBLY	55701J	-	-	-
7	DRAIN BRAKE FLUID	-	-	INFO	-
8	NO. 1 ENGINE UNDER COVER ASSEMBLY	51410	-	-	-

*A	for 2ZR-FXE	*B	for M20A-FXS
----	-------------	----	--------------

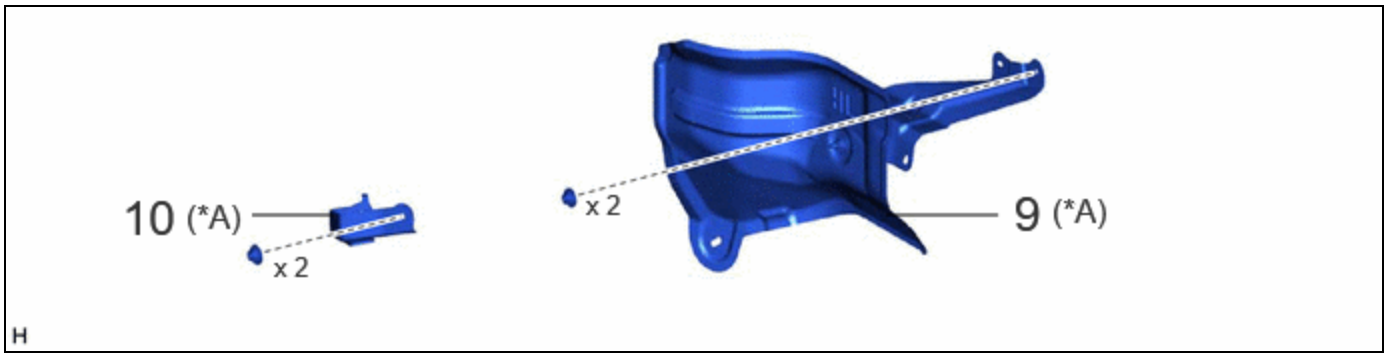

PROCEDURE		PART NAME CODE			
9	DASH PANEL HEAT INSULATOR	55225C	-	-	-
10	NO. 5 DASH PANEL INSULATOR PLATE	55228	-	-	-

*A	for M20A-FXS except PHEV Model	-	-
----	--------------------------------	---	---

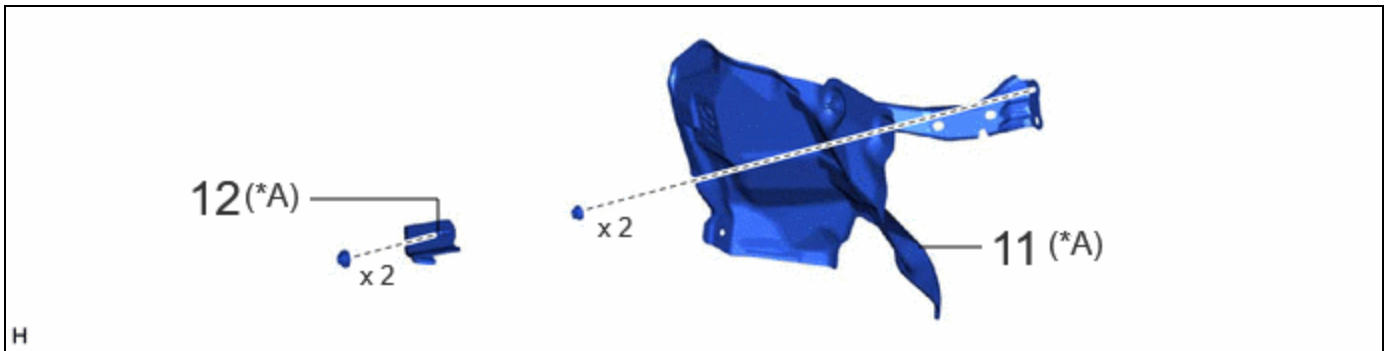

PROCEDURE		PART NAME CODE			
11	DASH PANEL HEAT INSULATOR	55225C	-	-	-
12	NO. 5 DASH PANEL INSULATOR PLATE	55228	-	-	-

*A	for PHEV Model	-	-
----	----------------	---	---

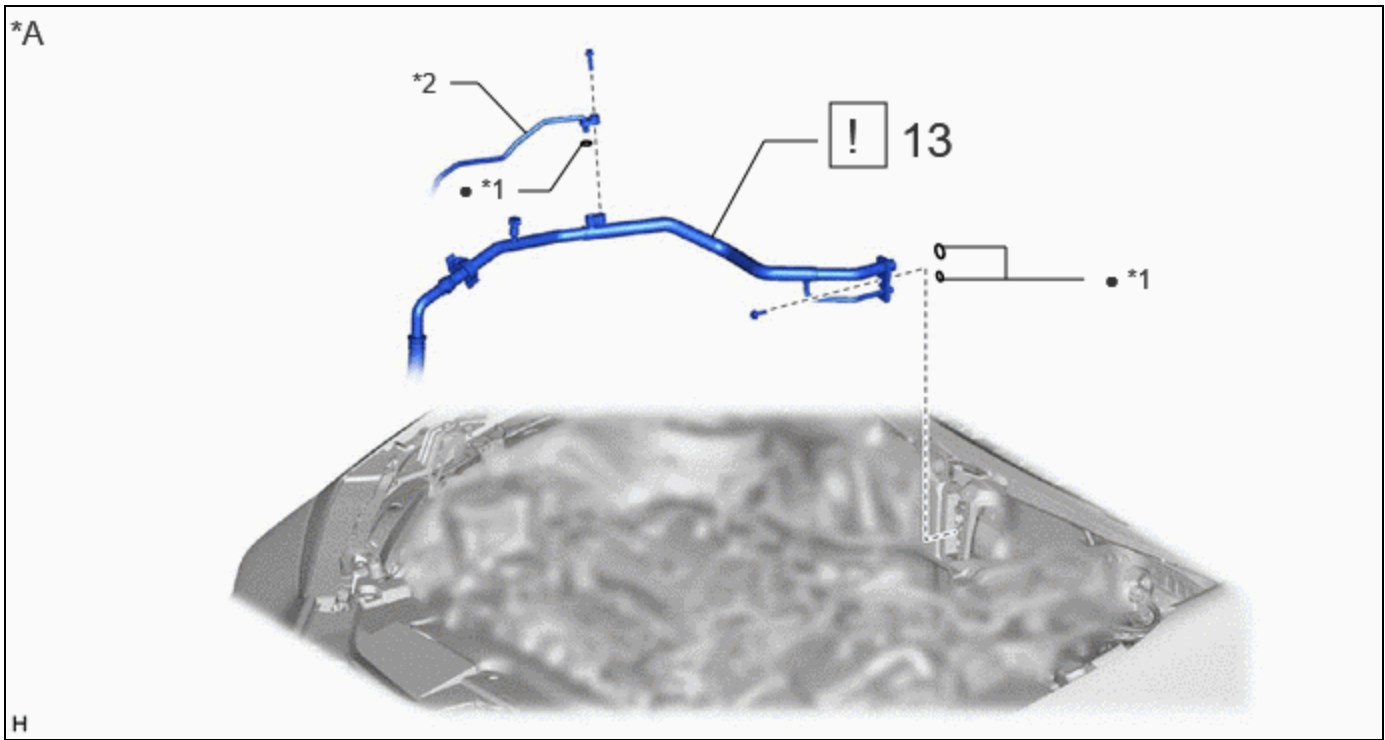

PROCEDURE		PART NAME CODE			
13	SUCTION PIPE SUB-ASSEMBLY	88707	INFO	-	-

*A	except PHEV Model	-	-
*1	O-RING	*2	AIR CONDITIONING TUBE AND ACCESSORY ASSEMBLY
●	Non-reusable part	-	-

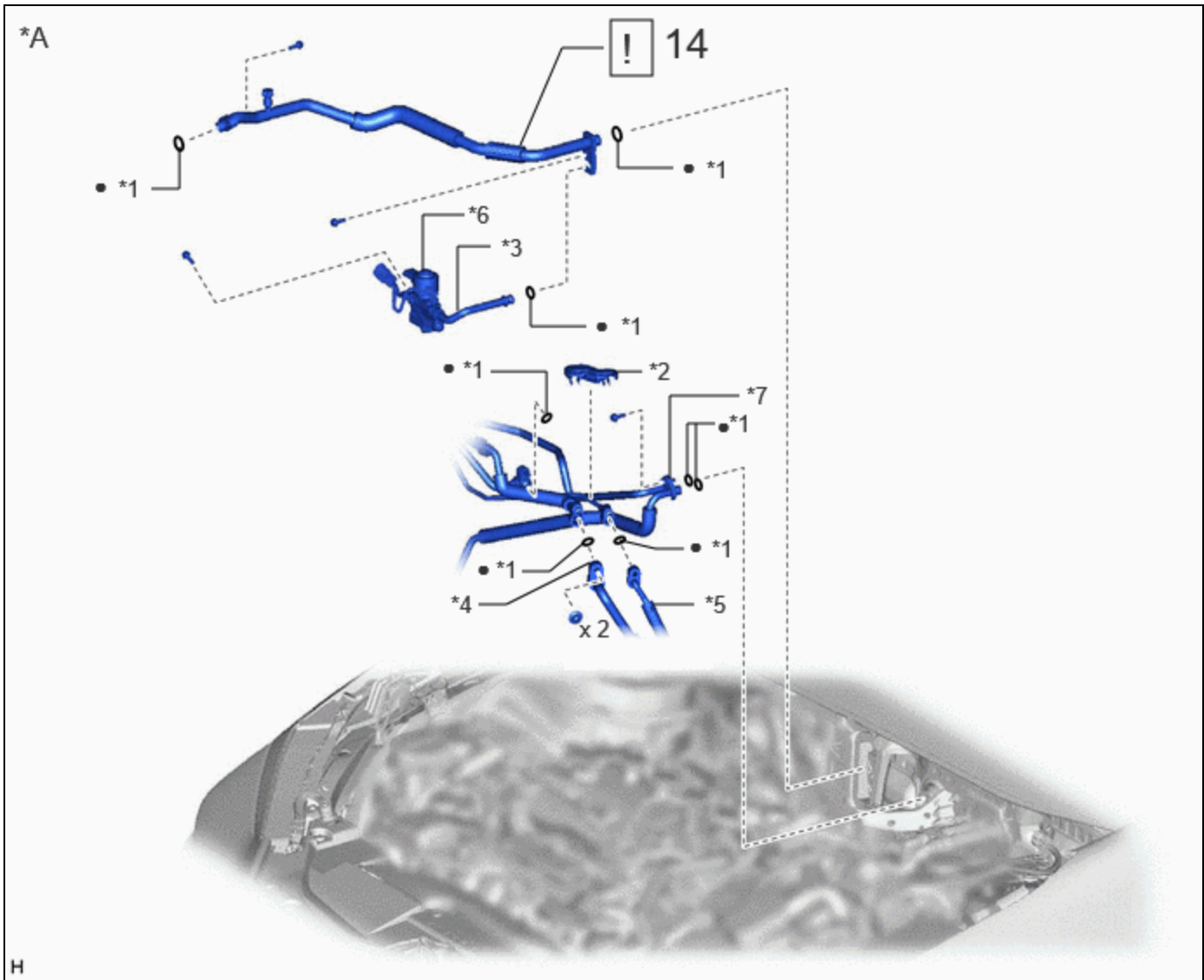

PROCEDURE		PART NAME CODE			
14	NO. 1 SUCTION TUBE	88717U	INFO	-	-

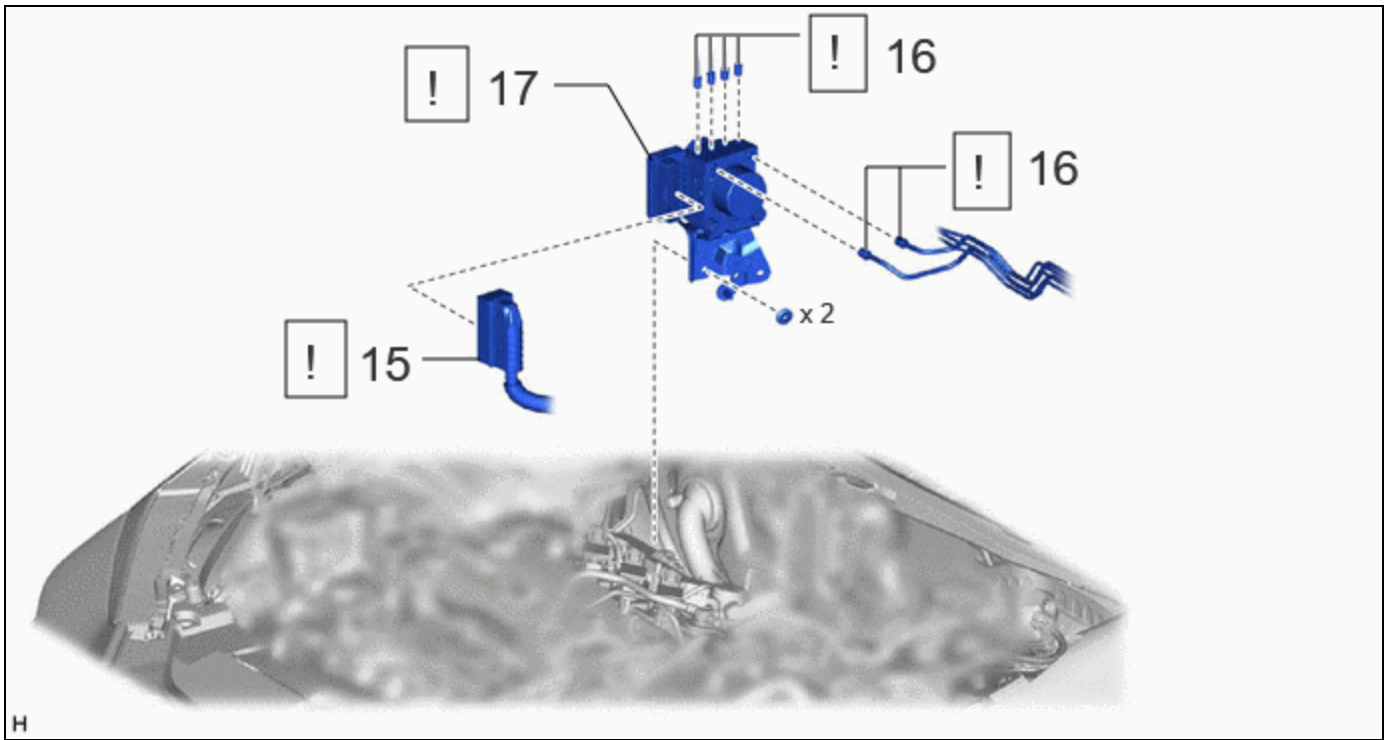

*A	for PHEV Model	-	-
*1	O-RING	*2	PIPING CLAMP
*3	NO. 7 DISCHARGE TUBE	*4	NO. 1 DISCHARGE TUBE
*5	LIQUID TUBE SUB-ASSEMBLY B	*6	COOLER EXPANSION VALVE
*7	DISCHARGE TUBE SUB-ASSEMBLY	-	-
•	Non-reusable part	-	-

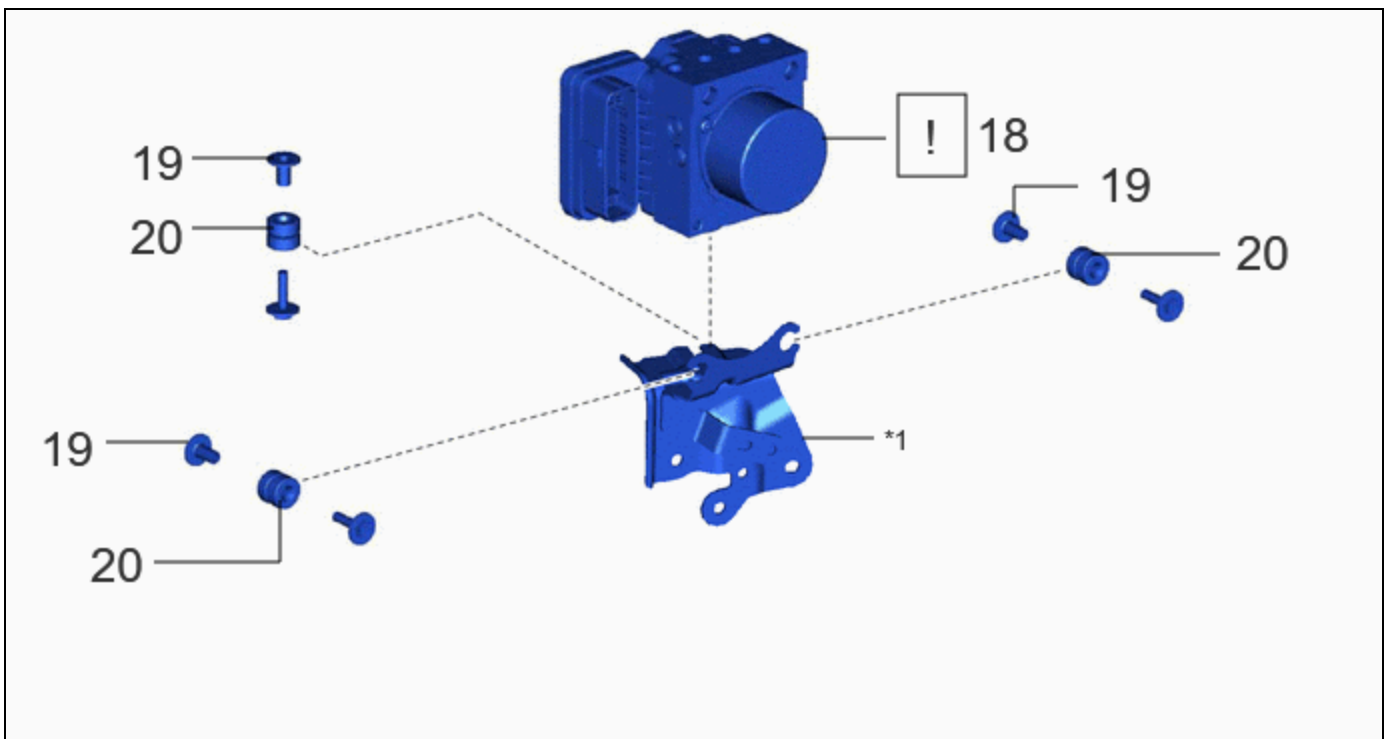

H

	PROCEDURE	PART NAME CODE			
15	ENGINE ROOM MAIN WIRE	82111	INFO	-	-
16	DISCONNECT BRAKE LINE	-	INFO	-	-
17	BRAKE ACTUATOR WITH BRACKET	-	INFO	-	-



	PROCEDURE	PART NAME CODE			
18	BRAKE ACTUATOR ASSEMBLY	44510	INFO	-	-
19	NO. 1 BRAKE ACTUATOR CASE COLLAR	44521A	-	-	-
20	BRAKE ACTUATOR BOLT CUSHION	44546A	-	-	-

*1	BRAKE ACTUATOR BRACKET ASSEMBLY	-	-
----	---------------------------------	---	---

PROCEDURE

1. PRECAUTION

	<p>NOTICE:</p> <p>After the ignition switch is turned off, there may be a waiting time before disconnecting the negative (-) auxiliary battery terminal.</p> <p>Click here INFO</p>
---	--

2. RECOVER REFRIGERANT FROM REFRIGERATION SYSTEM

for HFC-134a(R134a): Click here [INFO](#)

for HFO-1234yf(R1234yf): Click here [INFO](#)

3. DISCONNECT CABLE FROM NEGATIVE AUXILIARY BATTERY TERMINAL

for M20A-FXS: Click here [INFO](#)

for 2ZR-FXE: Click here [INFO](#)

4. REMOVE WINDSHIELD WIPER MOTOR AND LINK ASSEMBLY

Click here [INFO](#)

5. REMOVE WATER GUARD PLATE

Click here [INFO](#)

6. REMOVE OUTER COWL TOP PANEL SUB-ASSEMBLY

Click here [INFO](#)

7. DRAIN BRAKE FLUID

	<p>NOTICE:</p> <p>If brake fluid leaks onto any painted surface, immediately wash it off.</p>
---	--

8. REMOVE NO. 1 ENGINE UNDER COVER ASSEMBLY

for M20A-FXS: Click here [INFO](#)

for 2ZR-FXE: Click here [INFO](#)

9. REMOVE DASH PANEL HEAT INSULATOR (for M20A-FXS except PHEV Model)

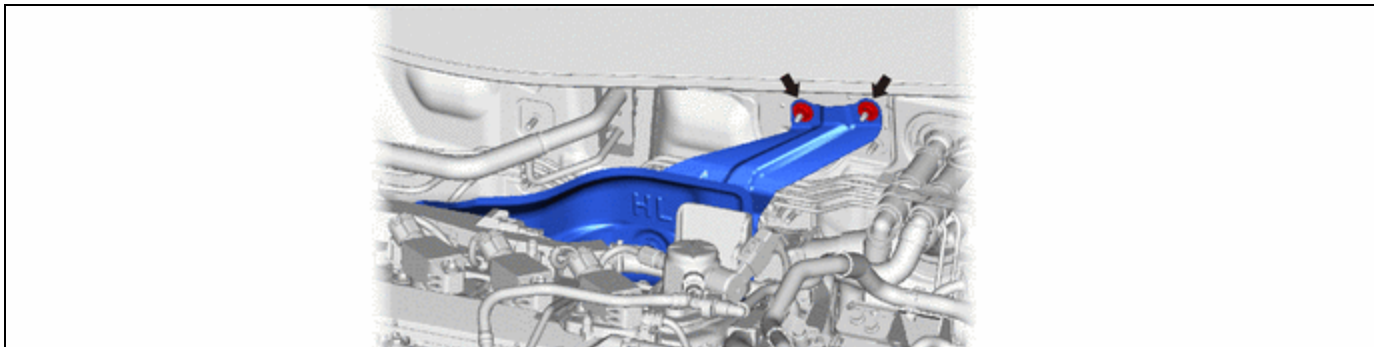

10. REMOVE NO. 5 DASH PANEL INSULATOR PLATE (for M20A-FXS except PHEV Model)

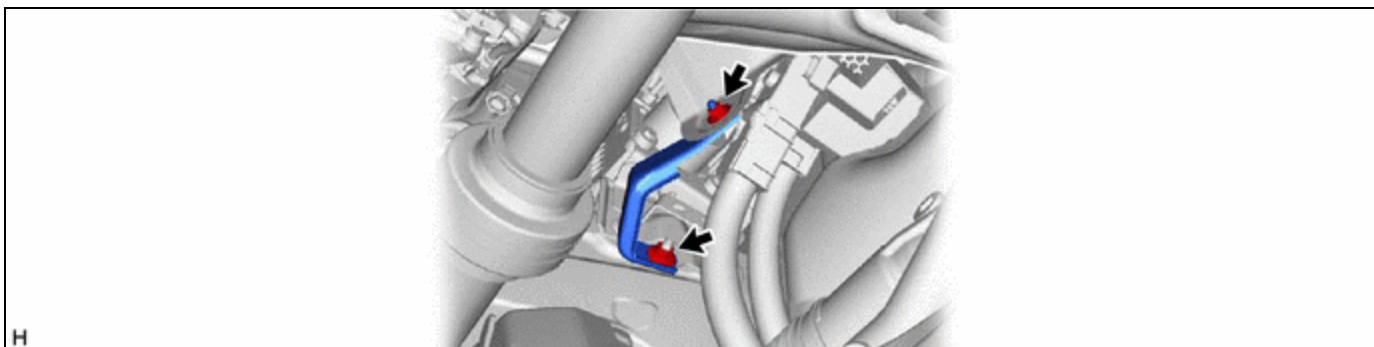

11. REMOVE DASH PANEL HEAT INSULATOR (for PHEV Model)

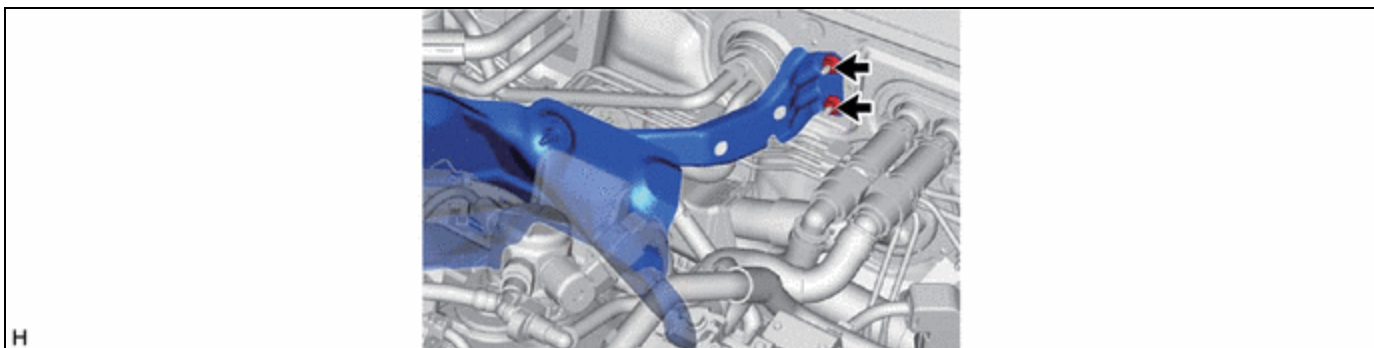

12. REMOVE NO. 5 DASH PANEL INSULATOR PLATE (for PHEV Model)

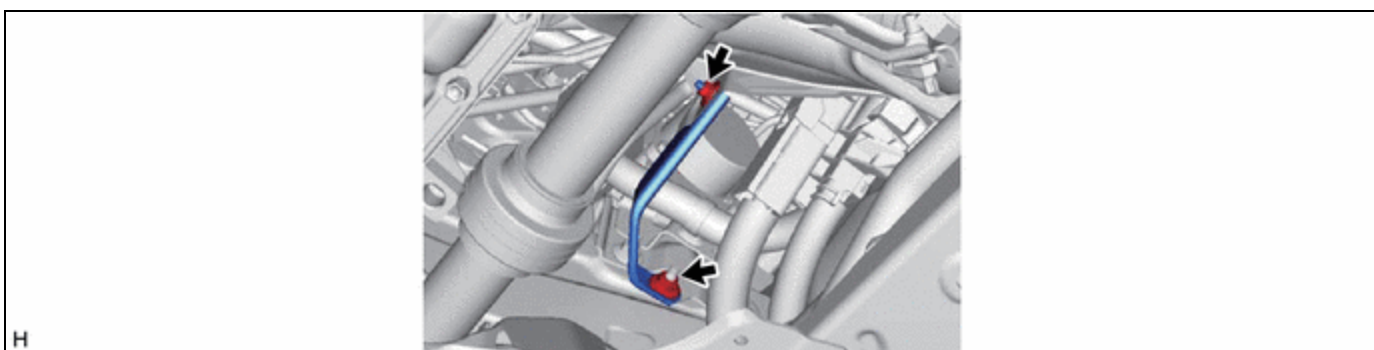

13. SEPARATE SUCTION PIPE SUB-ASSEMBLY (except PHEV Model)

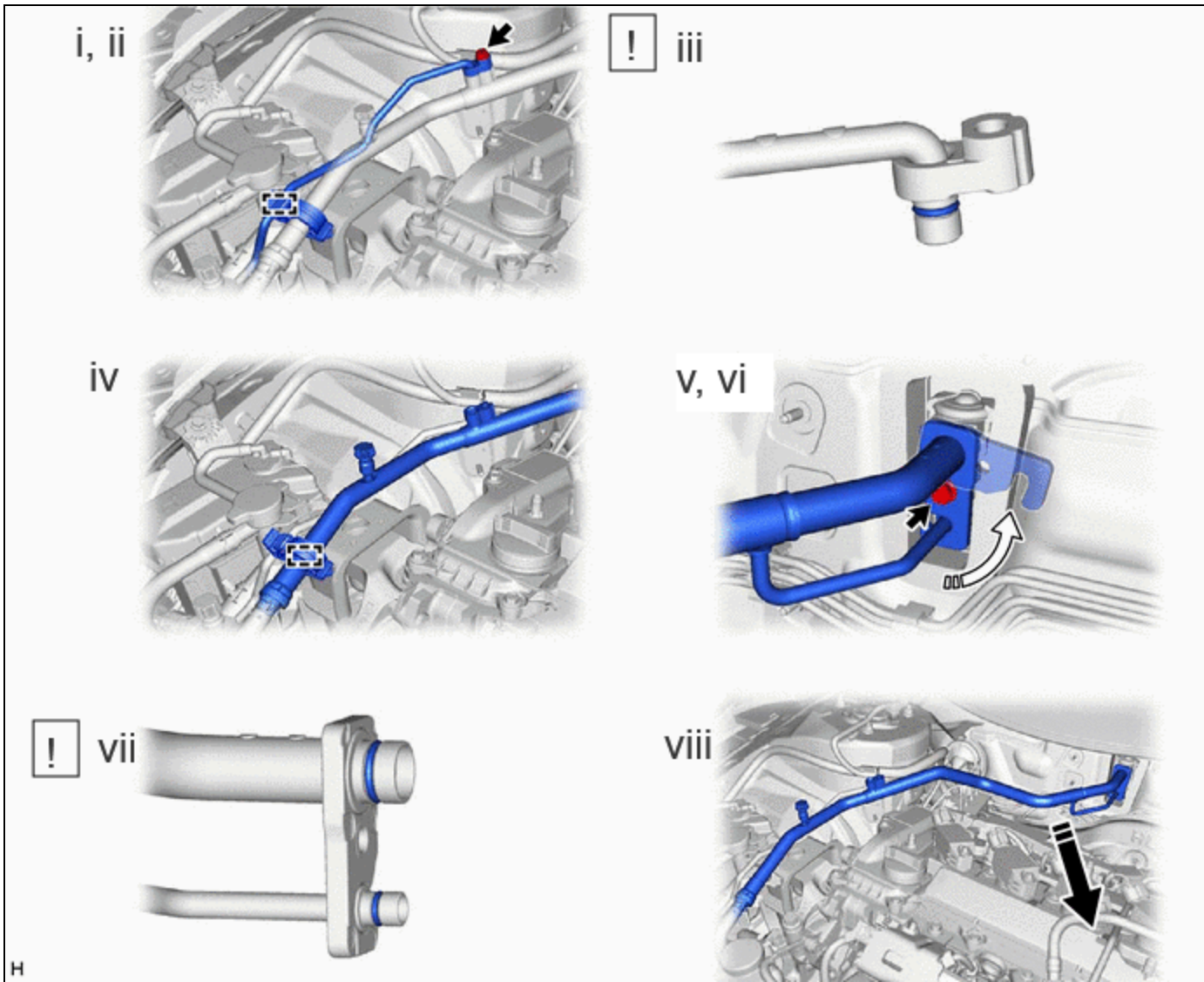

	Move in this Direction		Rotate in this Direction
--	------------------------	--	--------------------------

- (1) Remove the bolt and clamp.
- (2) Separate the air conditioning tube and accessory assembly.
- (3) Remove the O-ring from the air conditioning tube and accessory assembly.

NOTICE:

Seal the openings of the disconnected parts using vinyl tape to prevent moisture and foreign matter from entering them.

- (4) Remove the clamp.
- (5) Remove the bolt and rotate the hook connector as shown in the illustration.
- (6) Disconnect the suction pipe sub-assembly from the air conditioning unit assembly.
- (7) Remove the 2 O-rings from the suction pipe sub-assembly.

NOTICE:

Seal the openings of the disconnected parts using vinyl tape to prevent moisture and foreign matter from entering them.

(8) Move aside the suction pipe sub-assembly as shown in the illustration.

14. SEPARATE NO. 1 SUCTION TUBE (for PHEV Model)

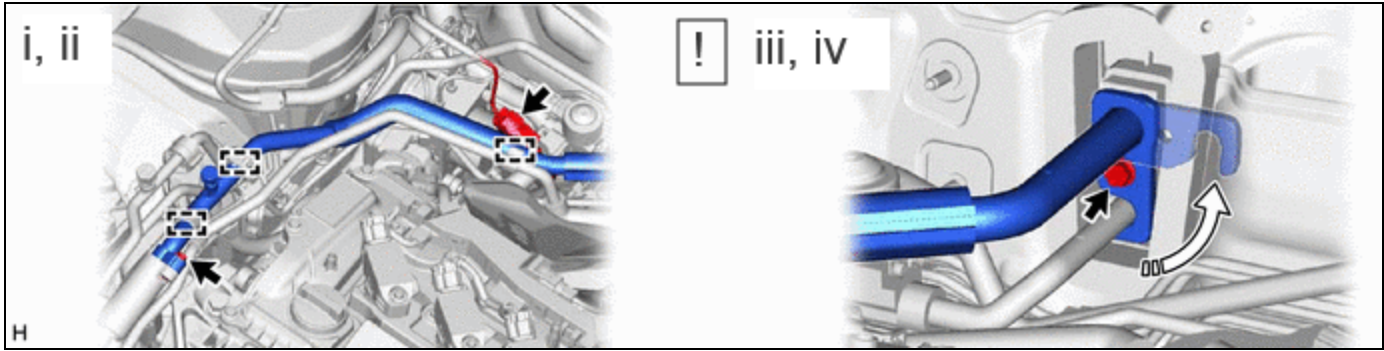

	Rotate in this Direction	-	-
---	--------------------------	---	---

- (1) Remove the bolt and 3 clamps.
- (2) Disconnect the connector and separate the connector from cooler expansion valve.
- (3) Remove the bolt and rotate the hook connector as shown in the illustration.
- (4) Disconnect the No. 1 suction tube from the air conditioning unit assembly.



- (1) Remove the 2 O-rings from the No. 1 suction tube.

NOTICE:

Seal the openings of the disconnected parts using vinyl tape to prevent moisture and foreign matter from entering them.

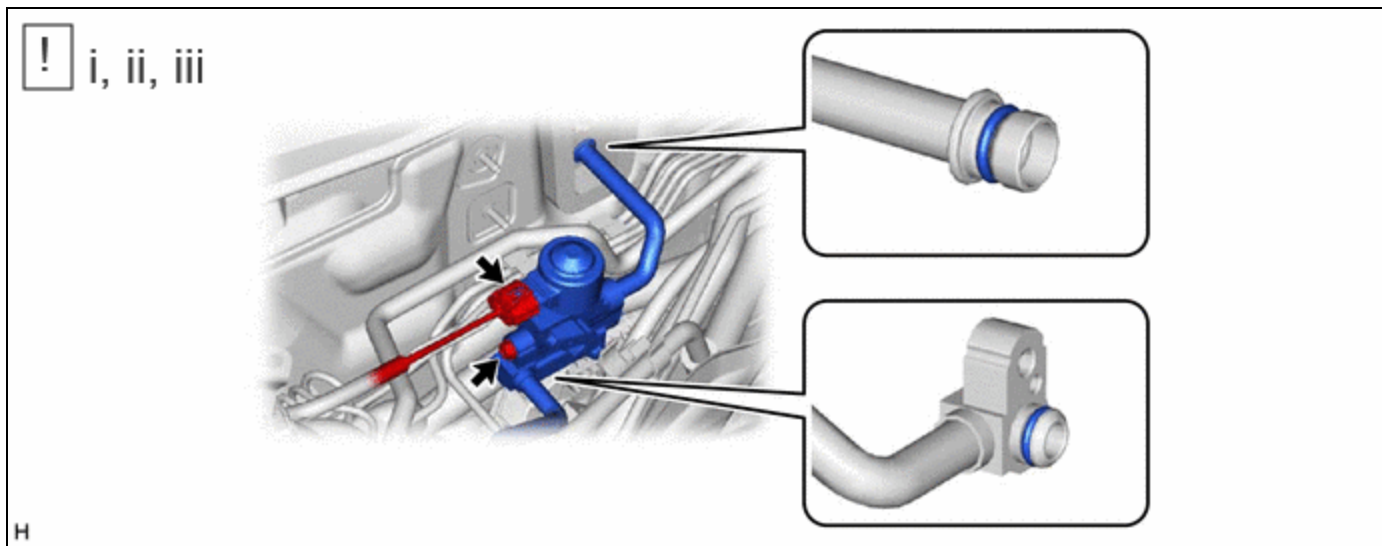

- (1) Disconnect the connector and remove the bolt.
- (2) Disconnect the No. 7 discharge tube from the air conditioning unit assembly.
- (3) Remove the 2 O-rings from the discharge tube.

NOTICE:

Seal the openings of the disconnected parts using vinyl tape to prevent moisture and foreign matter from entering them.

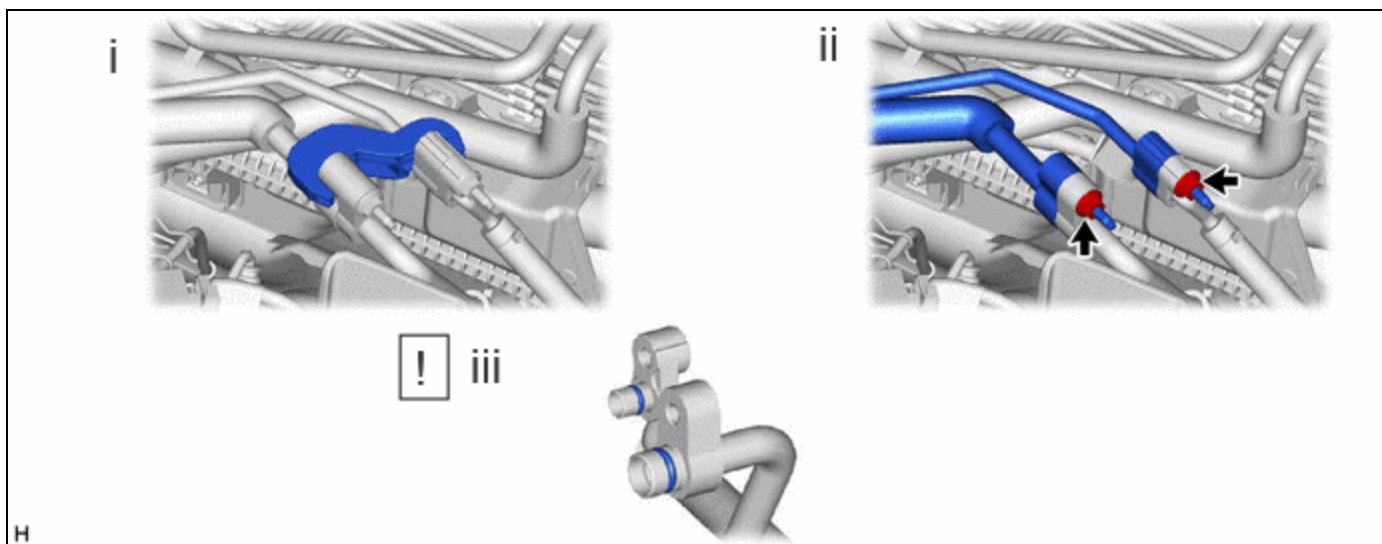

- (1) Remove the piping clamp from No. 1 discharge tube and liquid tube sub-assembly B.
- (2) Remove the 2 nuts and disconnect the No. 1 discharge tube and liquid tube sub-assembly B.
- (3) Remove the 2 O-rings from the No. 1 discharge tube and liquid tube sub-assembly B.

NOTICE:

Seal the openings of the disconnected parts using vinyl tape to prevent moisture and foreign matter from entering them.

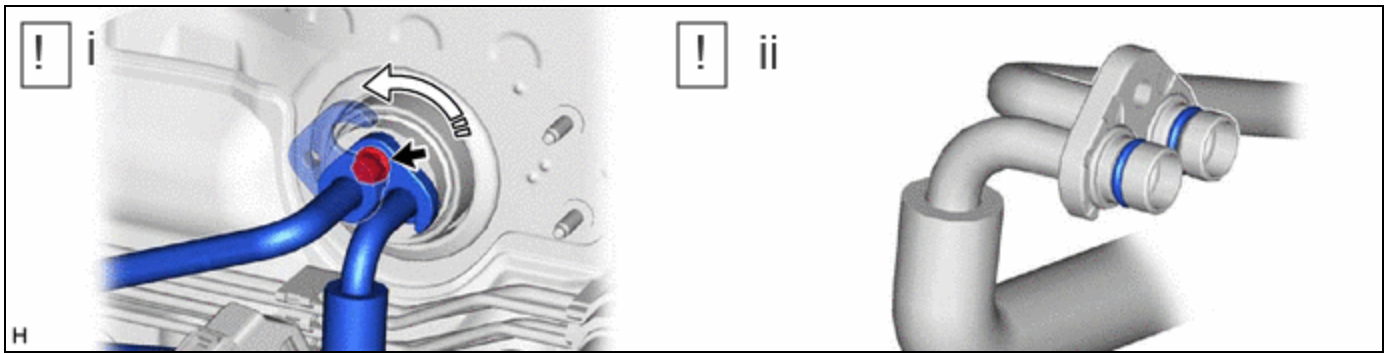



	Rotate in this Direction	-	-
---	--------------------------	---	---

- (1) Remove the bolt and rotate the hook connector as shown in the illustration.
- (2) Remove the 2 O-rings from the No. 8 discharge tube.

NOTICE:

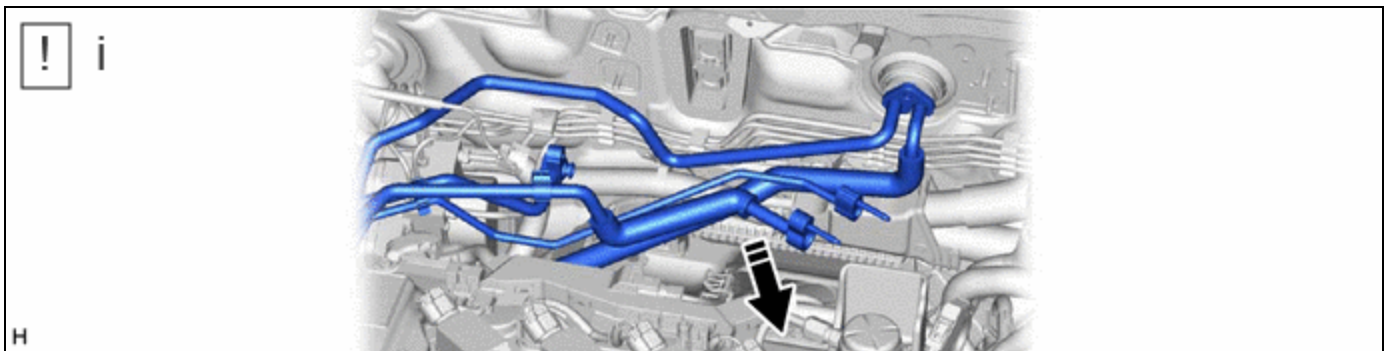
Seal the openings of the disconnected parts using vinyl tape to prevent moisture and foreign matter from entering them.





	Move in this Direction	-	-
---	------------------------	---	---

- (1) Move aside the air conditioning tube and accessory assembly as shown in the illustration.

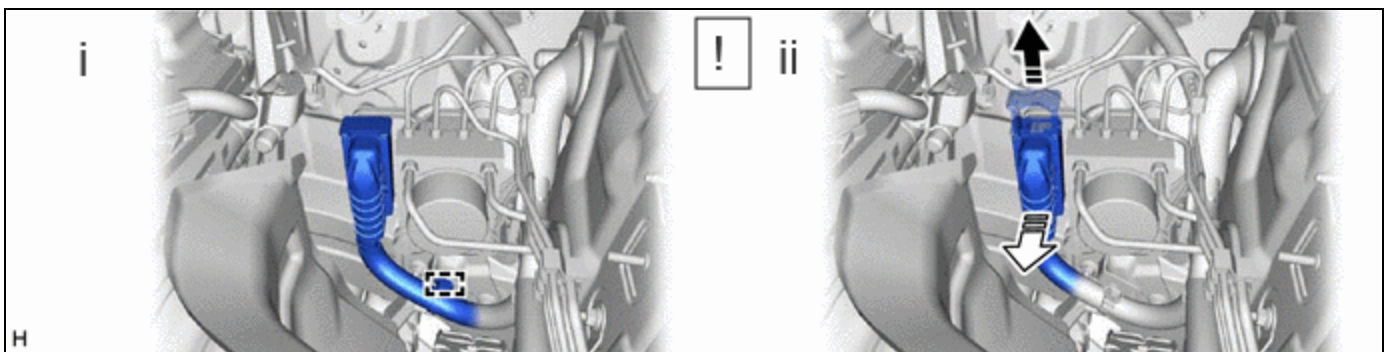
15. DISCONNECT ENGINE ROOM MAIN WIRE



	Release the lock lever		Disconnect the connector
---	------------------------	---	--------------------------

- (1) Disengage the clamp to separate the engine room main wire from the brake actuator bracket assembly.
- (2) Release the lock lever and disconnect the connector from the brake actuator assembly.

NOTICE:

Be careful not to allow any brake fluid to enter the connector.

16. DISCONNECT BRAKE LINE

	<p>NOTICE:</p> <ul style="list-style-type: none"> Do not kink or damage the brake lines. Do not allow any foreign matter such as dirt or dust to enter the brake lines from the connecting parts.
---	--

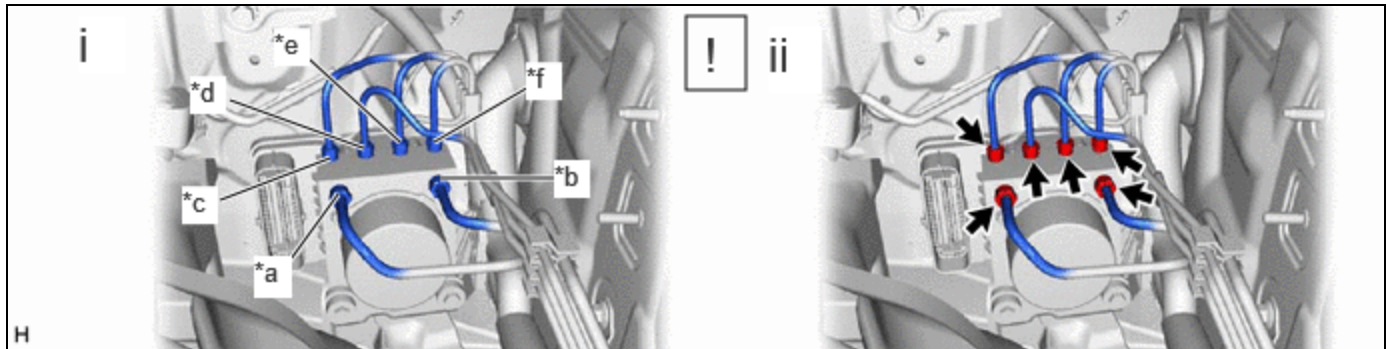

*a	From 1st Chamber of Brake Master Cylinder Assembly	*b	From 2nd Chamber of Brake Master Cylinder Assembly
*c	To Front Disc Brake Cylinder Assembly RH	*d	To Front Disc Brake Cylinder Assembly LH
*e	To Rear Disc Brake Cylinder Assembly RH	*f	To Rear Disc Brake Cylinder Assembly LH

- (1) Use tags or make a memo to identify the places to reconnect the brake lines.
- (2) Using a union nut wrench, disconnect the 6 brake lines from the brake actuator assembly.

17. REMOVE BRAKE ACTUATOR WITH BRACKET

	<p>NOTICE:</p> <ul style="list-style-type: none"> Do not kink or damage the brake lines. Do not allow any foreign matter such as dirt or dust to enter the brake lines from the connecting parts. Be careful not to allow any brake fluid to enter the connector. Do not hold the brake actuator with bracket by the connector. Do not drop the brake actuator with bracket when carrying it. <p>HINT:</p> <p style="color: green;">Remove the brake actuator with bracket while avoiding the brake lines.</p>
---	---

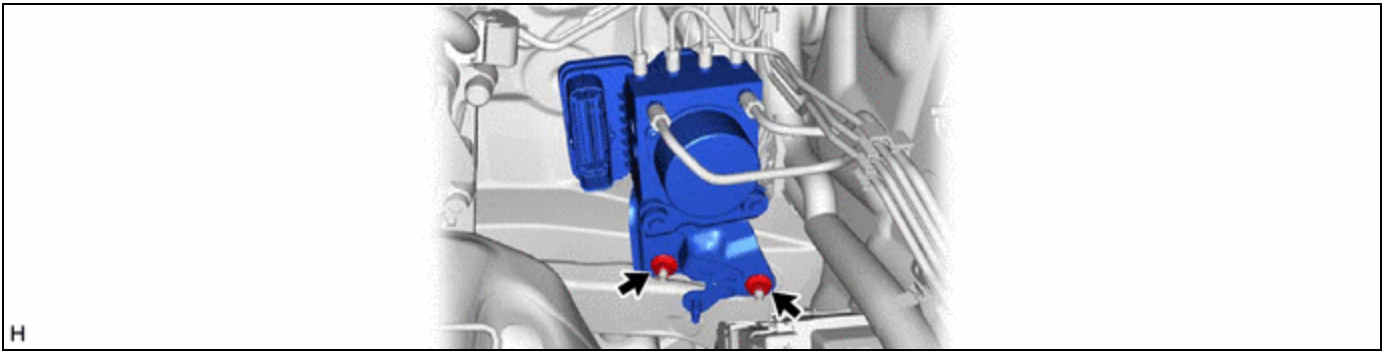

18. REMOVE BRAKE ACTUATOR ASSEMBLY



NOTICE:

- Do not hold the brake actuator assembly by the connector.
- Do not drop the brake actuator assembly when carrying it.

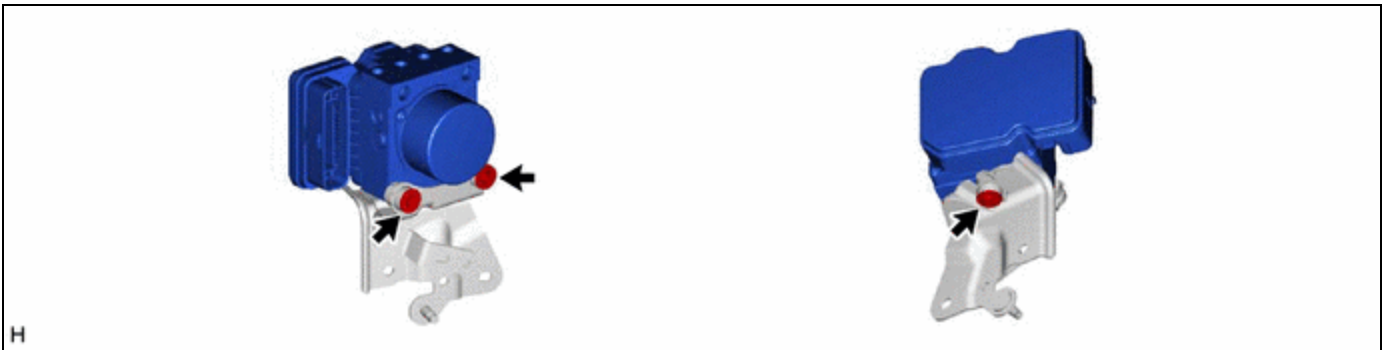

19. REMOVE NO. 1 BRAKE ACTUATOR CASE COLLAR

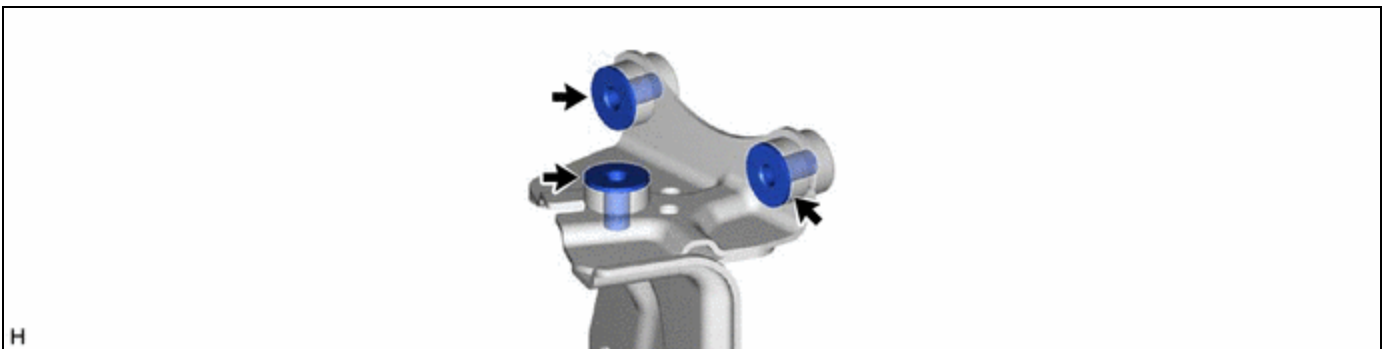

20. REMOVE BRAKE ACTUATOR BOLT CUSHION

