

Last Modified: 12-04-2024	6.11:8.1.0	Doc ID: RM100000028TZE
Model Year Start: 2023	Model: Prius Prime	Prod Date Range: [12/2022 -]
Title: GARAGE DOOR OPENER: GARAGE DOOR OPENER SYSTEM (for EC Inner Mirror): REGISTRATION; 2023 - 2024 MY Prius Prius Prime [12/2022 -]		

REGISTRATION

PROCEDURE

1. REGISTER TRANSMITTER CODE

HINT:

- The vehicle garage door opener records transmitter codes for systems such as garage doors, gates, entry gates, door locks, home lighting systems, security systems or other transmitter code based systems.
- The garage door opener is built into the inner rear view mirror assembly. If replacing the inner rear view mirror assembly, transmitter codes for any systems previously registered in the garage door opener must be re-registered.

(a) Re-registration of codes in the garage door opener system (registration mode).

CAUTION:

Do not perform transmitter code registration for a system if people or objects are near the system. When registering transmitter codes for a system, injury or damage can occur because the system may open, close, unlock or otherwise operate.

NOTICE:

- Before transmitter code registration, confirm that all the electrical systems (headlight, blower motor, rear defogger, etc.) are turned off and no key is in the vehicle.
- The garage door opener cannot be used with systems that:
 - (1) Were manufactured before April 1, 1982.
 - (2) Do not meet federal safety standards (for example, garage doors without a jam protection function).

HINT:

- A maximum of 3 transmitter codes can be registered with the garage door opener system. It is possible to register 1 handheld transmitter code (original transmitter) for each of the 3 garage door opener system switches.
- Disconnecting the vehicle battery will not clear the transmitter codes registered in the garage door opener system.
- An attempt to overwrite a previously registered code may fail. In this case, the previously registered transmitter code will not be cleared.
- To successfully program the garage door opener system, it may be necessary to replace the handheld transmitter battery before programming.
- If registration is performed when the battery level of the transmitter is low, the transmitted radio waves may be too weak and registration may not complete properly.

(1) Step 1:

Select a garage door opener ("HomeLink") switch for transmitter code registration and check that the ("HomeLink") indicator light flashes.

HINT:

Perform step 3 within 60 seconds of step 1, or the indicator light will stop flashing and programming will not be able to be completed.

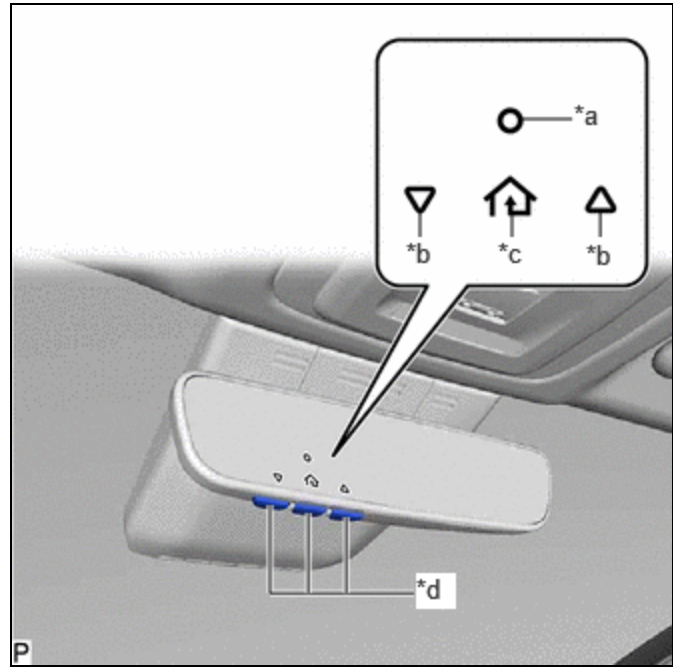

*a	("HomeLink") Indicator Light
*b	Garage Door Operation Indicators
*c	("HomeLink") Icon
*d	Garage Door Opener ("HomeLink") Switches

(2) Step 2:

Point the remote control transmitter for the device at the inner rear view mirror assembly, 2.5 to 7.5 cm (1.0 to 3.0 in.) from the garage door opener ("HomeLink") switches.

HINT:

Keep the ("HomeLink") indicator light in view while programming.

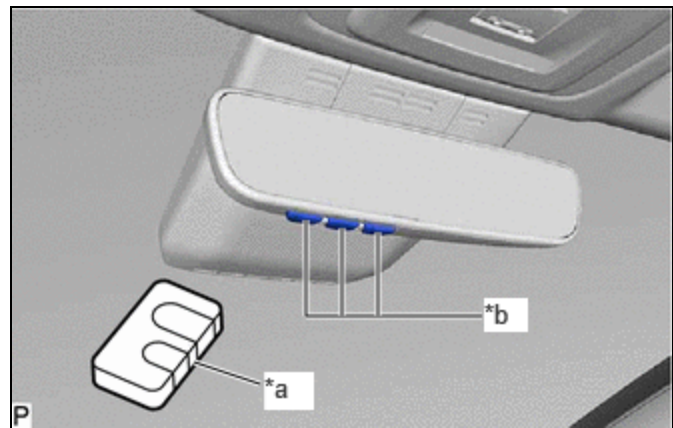

*a	Handheld Transmitter
*b	Garage Door Opener ("HomeLink") Switches

(3) Step 3:

for USA:

except Entry Gate

Press and hold the handheld transmitter button until the ("HomeLink") indicator light changes from slowly flashing (orange) to rapidly flashing (green) (rolling code) or continuously lit (green) (fixed code), then release the handheld transmitter button.

for Entry Gate

Repeatedly press and release the handheld transmitter button at 2 second intervals until the ("HomeLink") indicator light changes from slowly flashing (orange) to rapidly flashing (green) (rolling code) or continuously lit (green) (fixed code).

for Canada:

Repeatedly press and release the handheld transmitter button at 2 second intervals until the ("HomeLink") indicator light changes from slowly flashing (orange) to rapidly flashing (green) (rolling code) or continuously lit (green) (fixed code).

(4) Step 4:

Test the ("HomeLink") operation by pressing the newly programmed switch and observing the indicator light.

HINT:

- Device with fixed code: if the indicator light is solid and continuous, programming has been completed and the device should activate when the garage door opener ("HomeLink") switch is pressed and released.
- Device with rolling code: if the indicator light flashes rapidly, the garage door opener motor (or other device) is equipped with a rolling code. Complete the programming process by firmly pressing and holding the programmed garage door opener ("HomeLink") switch for 2 seconds and then release the handheld transmitter button.
- If the garage door or other device does not operate, proceed to "Programming a rolling code system".

(5) If the transmitter code registration was successful, the ("HomeLink") indicator light of the garage door opener flashes (green) at a cycle of 10 Hz (rapidly). If no malfunction occurs, release both the garage door opener ("HomeLink") switch and handheld transmitter button.

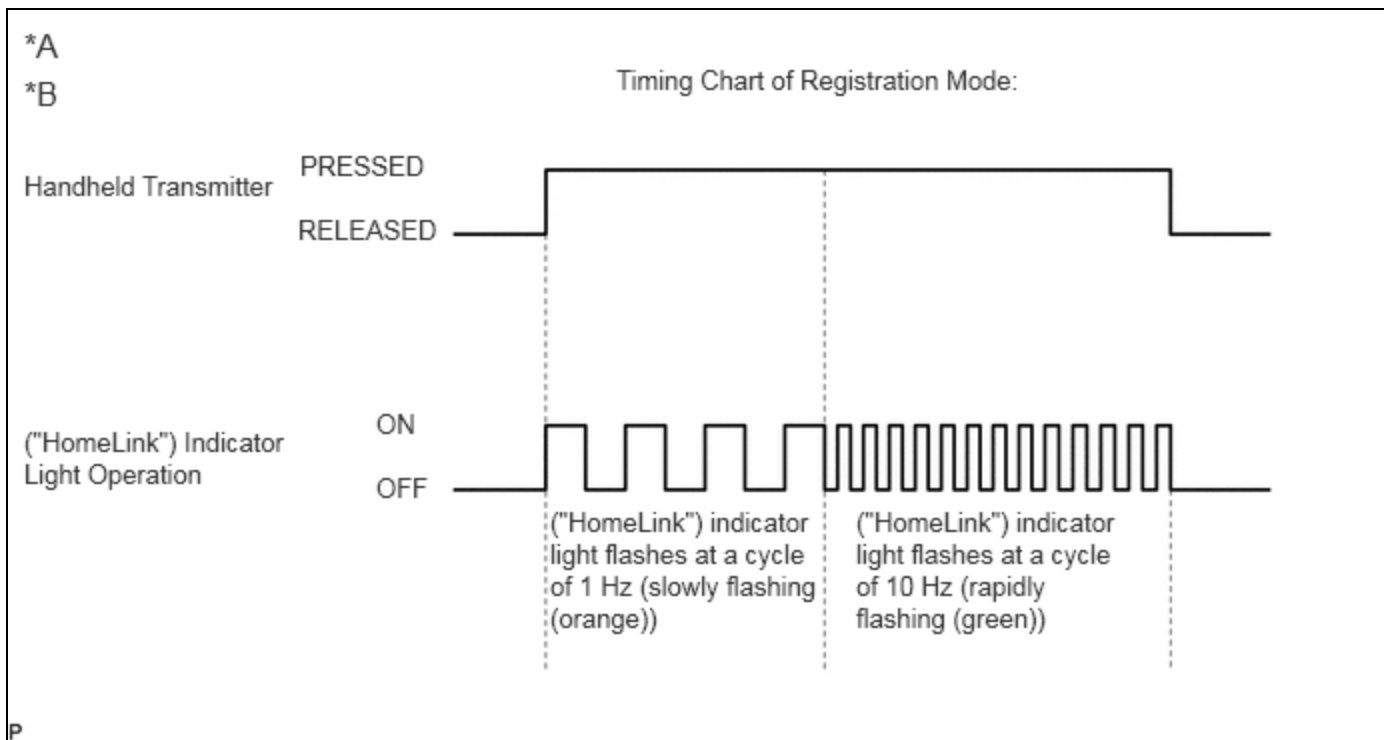

*A	for USA	*B	except Entry Gate
----	---------	----	-------------------

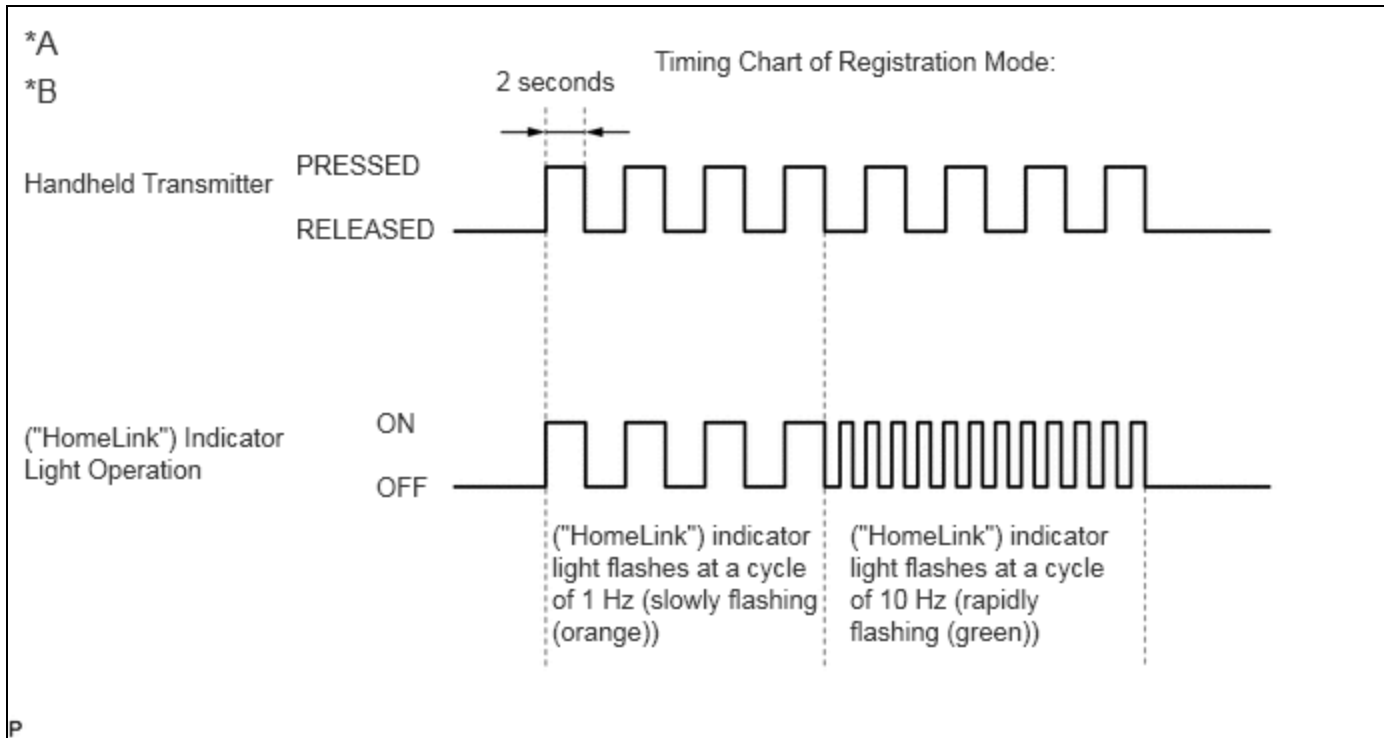

*A	for USA	*B	for Entry Gate
----	---------	----	----------------

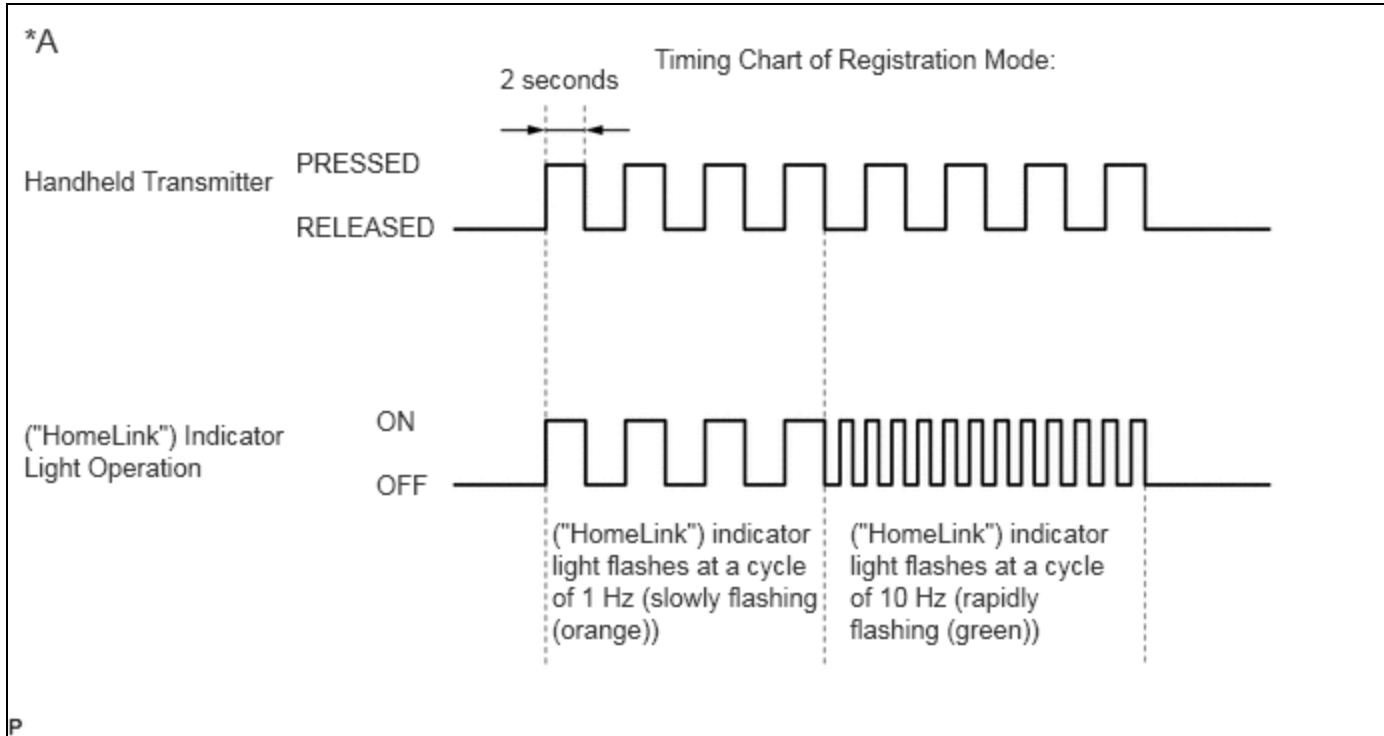

*A	for Canada	-	-
----	------------	---	---

HINT:

- If transmitter code registration fails:
 - (1) The battery in the handheld transmitter may be weak or needs to be replaced.
 - (2) The handheld transmitter and opener device to be registered may not be compatible with the garage door opener.
- Some transmitter signals stop after 1 to 2 seconds. For these types of transmitters:
 - (1) Press and hold one of the garage door opener ("HomeLink") switches.

(2) Press and release the handheld transmitter button every 2 seconds. Check if the transmitter code was successfully registered.

- After entering the garage door opener registration mode, transmitter code registration must be completed within 60 seconds. If 60 seconds elapse, the garage door opener will enter low power mode (refer to "Low Power Mode" below).

(6) Repeat the steps above to program another device for any of the remaining garage door opener ("HomeLink") switches.

(b) Clearing transmitter codes in the garage door opener system (clear mode).

HINT:

All 3 registered transmitter codes will be cleared. No option exists for only erasing one transmitter code.

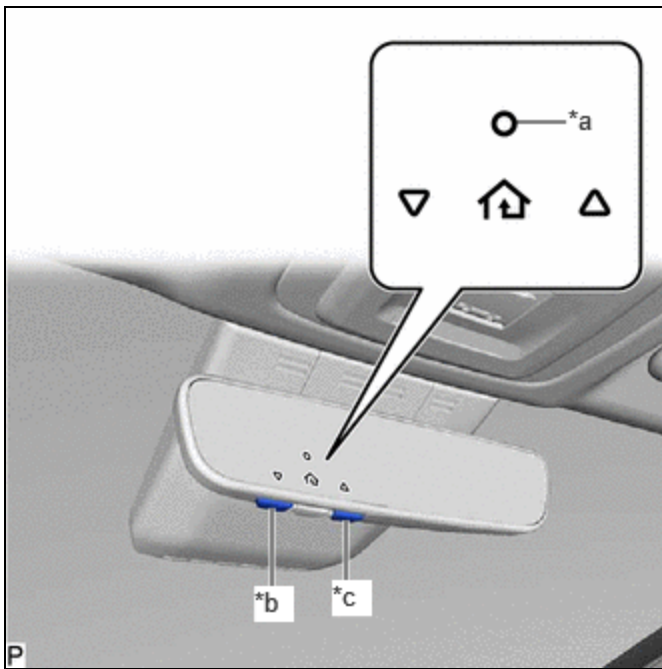

*a	("HomeLink") Indicator Light
*b	Garage Door Opener ("HomeLink") Switch 1
*c	Garage Door Opener ("HomeLink") Switch 3

(1) Press and hold the garage door opener ("HomeLink") switches 1 and 3 for 10 seconds until the ("HomeLink") indicator light changes from continuously lit orange to rapidly flashing green.

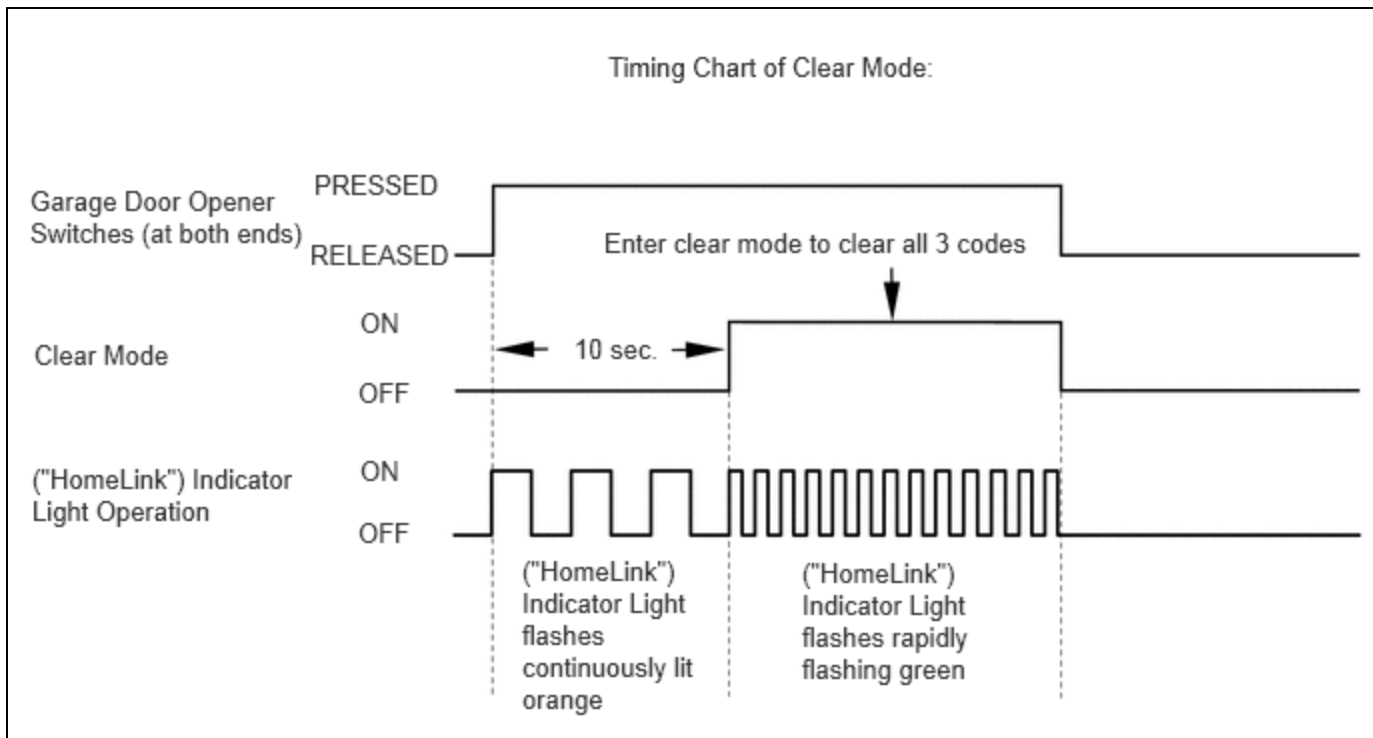

(c) Low power mode:

- (1) If a garage door opener ("HomeLink") switch is held for 60 seconds or more, the garage door opener will enter low power mode to reduce power consumption. When the garage door opener has entered low power mode, the ("HomeLink") indicator light turns off.

2. ROLLING CODE SYSTEMS

(a) If the handheld transmitter for the opener device (customer's garage door) being programmed uses a rolling code, it may be necessary to "train" the garage door opener device.

HINT:

- "Train" refers to causing the opener device (customer's ceiling mounted garage door opener) to recognize a non-rolling code.
- The steps required to "train" an opener device may vary depending on the model, type, age, and manufacturer of the device.

- (1) Locate the training button on the opener device.
- (2) Press the training button.
- (3) Within 30 seconds, press and release the programmed garage door opener ("HomeLink") switch twice. Some opener devices may require the garage door opener ("HomeLink") switch to be pressed 3 times.

HINT:

The vehicle garage door opener system should now operate the opener device. Opener device refers to a device such as a ceiling mounted garage door opener, which is located at the customer's residence. It is necessary to read the instructions

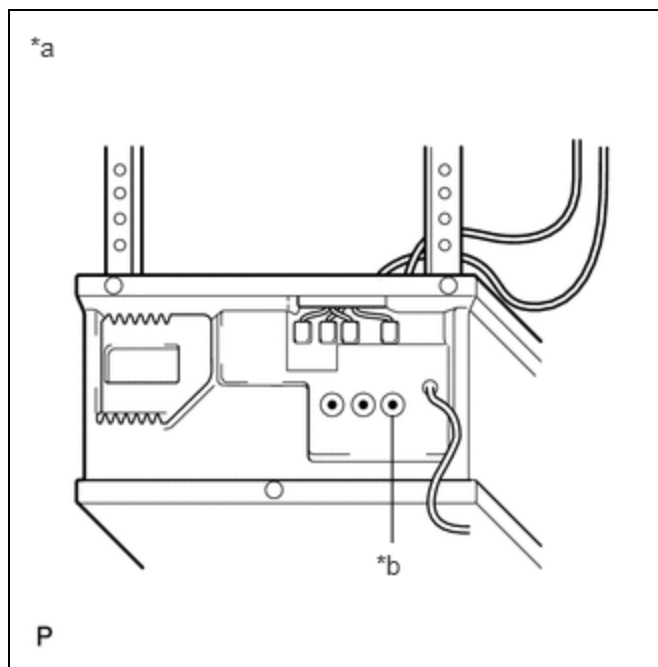

*a	Example
*b	Training Button

for the customer's opener device, to allow the above procedure to be performed safely and successfully. The customer should be aware that performing this procedure will result in a lowered level of security for the customer's opener device.

