

QT523A

Brake Inspection

Start



**TECHNICAL
TRAINING**

INTRODUCTION

This Quick Training Guide has been designed as a job aid to support technicians performing brake inspections. To navigate through the document, select the tabs from the top or the side of the screen.

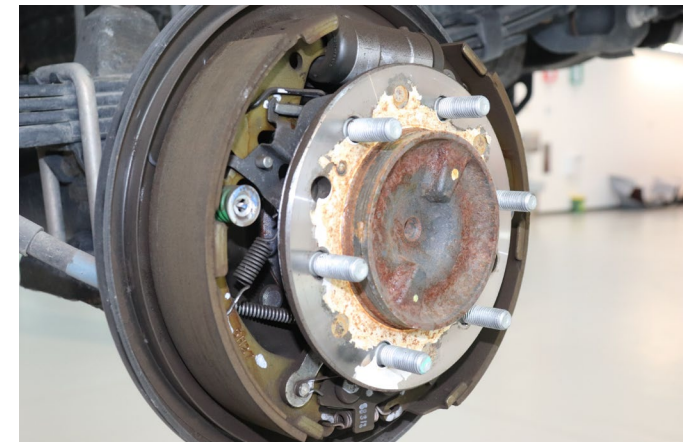
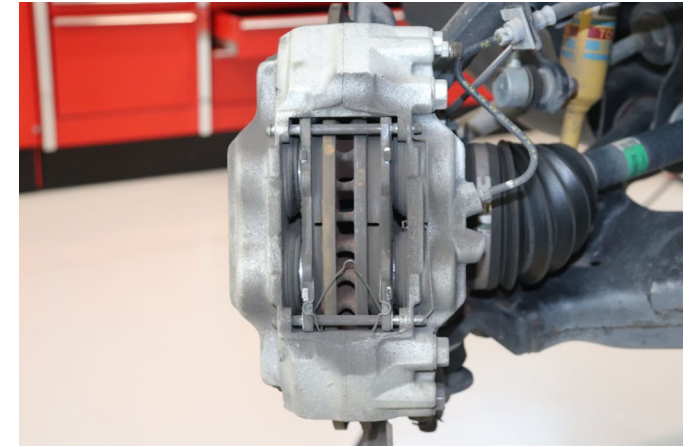

FLUID CHECK

- Brake fluid level could be an indicator of pad/lining wear. As the brake lining wears, the fluid will drop in the reservoir. This is due to the brake caliper piston's extended travel distance to engage the brake pads onto the brake disc, therefore, additional brake fluid is required to overcome the travel distance of the caliper piston
- If the brake fluid is below the MAX line, but above the MIN line, do not top off unless you are replacing brake pads/linings. Topping off the fluid before brake pad service could lead to an overflow of the reservoir during brake pad service. Adjust the fluid level to the MAX line when refilling (after brake pad service)
- If the fluid level is below the MIN line, inspect for brake fluid leaks. When adjusting the fluid level after it has been below the MIN line, the brake system may require bleeding (air purging)
- When servicing vehicles with a hydraulic brake booster, pressure must be released from the brake accumulator and fluid returned to the reservoir before checking brake fluid level. (Procedures may vary depending on model- Refer to the Repair Manual for details)
- When checking fluid level on vehicles with Electronically Controlled Brakes (ECB), the ECB system must be operating. Fluid inspection procedures for ECB systems vary by model. Refer to the Repair Manual for details
- The fluid reservoir cap indicates the type of brake fluid that is required for the brake system

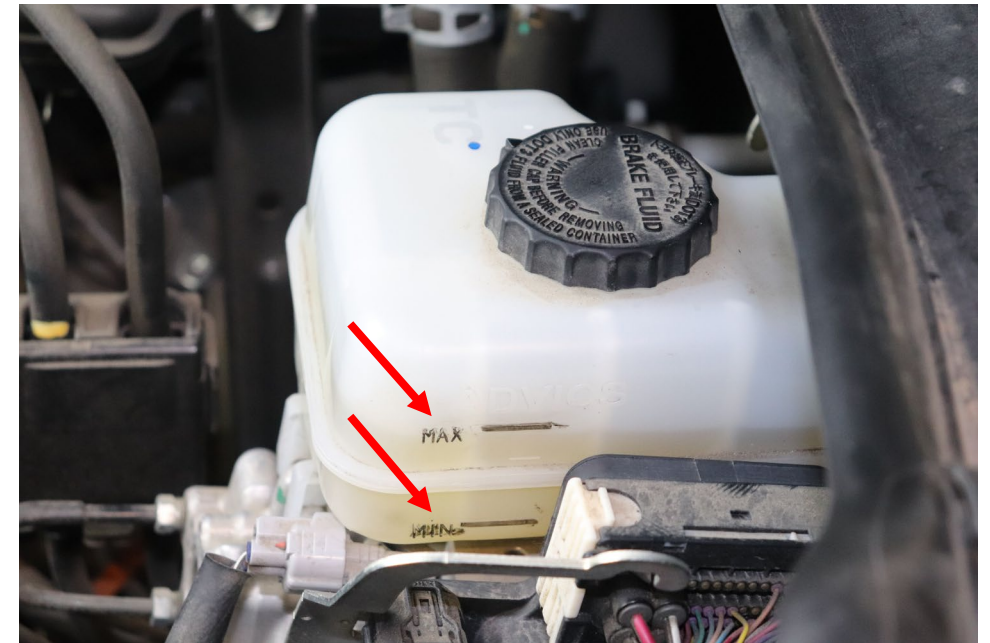

Hydraulic Brake Booster Reservoir

FLUID CONDITION

- Fluid should be clear with a light amber color
- Fluid that is brown or muddy indicates a problem
- On vehicles with a hydraulic brake booster, fluid that appears “milky” contains excessive air and should be bled
- Brake fluid is hygroscopic, meaning it absorbs moisture from the air. Uncapped brake fluid absorbs moisture, which will reduce the boiling point and can lead to system corrosion; this can lead to seized caliper pistons and/or wheel cylinders
- “Supplemental services,” such as brake fluid flushing, are among those repairs that are not recommended in Toyota’s Service Bulletins, Repair Manuals, etc. However, to aid in the brake fluid inspection process, commercially available test equipment is available. Brake fluid can be inspected for a range of conditions such as moisture content, PH level, and suspended copper content, which can be an indicator of internal system condition



Moisture Tester

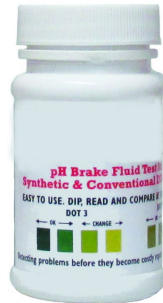

PH Test Strips



Copper Test Strips

- Petroleum products, such as power steering fluid or motor oil, tend to float on top of brake fluid and will swell rubber brake components and seals. The bottom right picture demonstrates how rubber brake parts will swell in the presence of petroleum products. The same rubber cap was submerged in DOT 3 brake fluid only and in a combination of DOT 3 brake fluid and Power Steering Fluid. The rubber cap in the DOT 3 and Power Steering Fluid combination has swelled

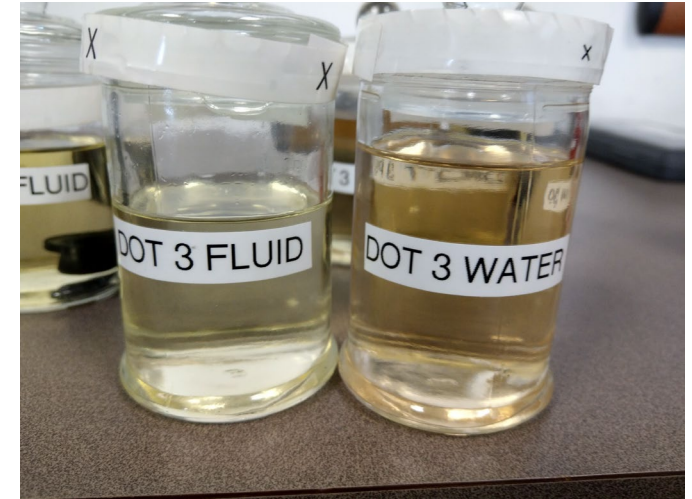

Brake fluid vs. brake fluid contaminated with water

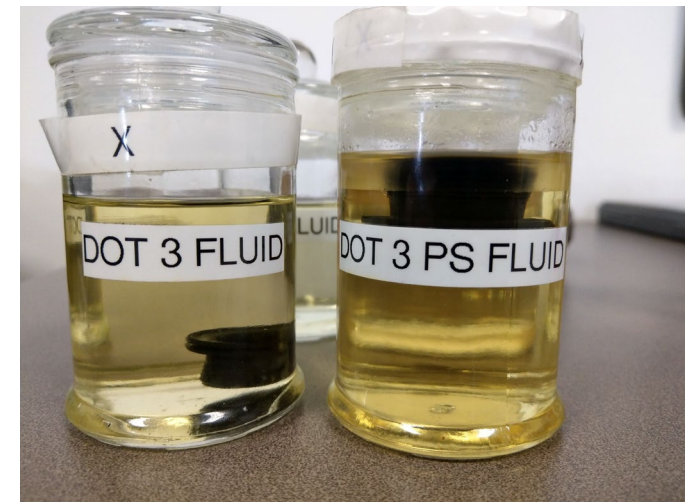

Brake fluid vs. brake fluid contaminated with power steering fluid

FLUID HANDLING

- Brake fluid is a solvent; it can dissolve paint on contact. Wash brake fluid off painted surfaces immediately with soap and water
- Brake fluid must be disposed of according to local regulations and EPA guidelines



Paint Damage from Brake Fluid



Typical fluid recycling containers

HOSE AND LINE INSPECTION

Check for Leaks

- Check for leaks at the master cylinder, brake booster, all visible hoses, and brake lines and fittings

Check Condition of Hoses and Brake Lines

- Flexible hoses should be free of any cracks, abrasions or bulges
- Metal brake lines should not show any signs of rust, damage, or wear
- Check for any vehicle modifications that may affect the brake lines or hoses

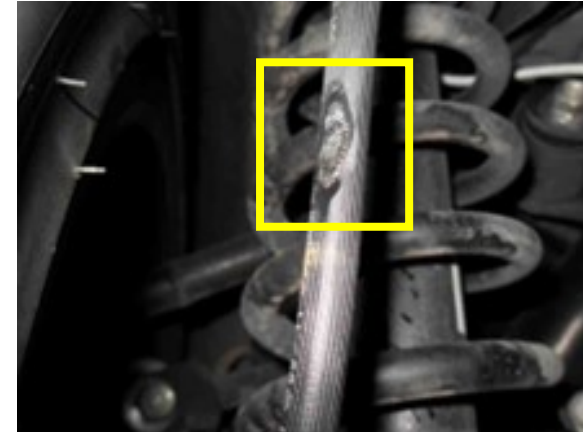

Abrasion damage



Cracked / split brake hose



Bulge in brake hose

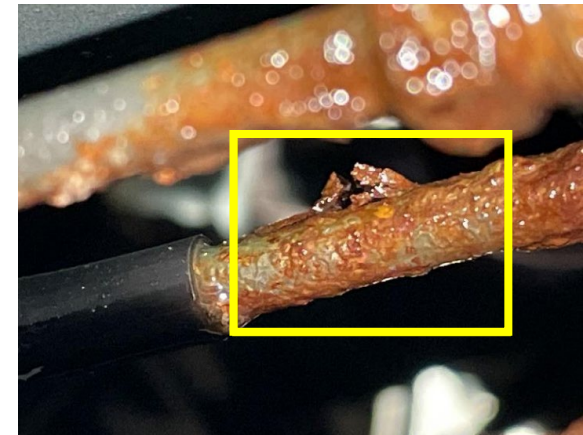

Rust / corrosion causing leak in steel line

PAD MEASUREMENT

- On floating brake caliper designs, insert the brake lining thickness gauge into the inspection hole to measure the inner brake pad thickness; inspect the outer pad in the location shown using a steel or pocket ruler
- On fixed caliper brake designs, full access to the inner and outer pads is available; measure with the brake lining thickness gauge
- Measure the thickness of the pad lining only, not the metal backing. Replace pads when thickness has reached 1mm or less
- Record the brake pad "Before" measurements on the back of the paper Repair Order or in the notes section of the Electronic Repair Order, and on the MPI Sheet. "After" measurements may be required for certain warranty repairs. Refer to Toyota Warranty Policy and Procedures for details



Brake Lining Thickness Gauge

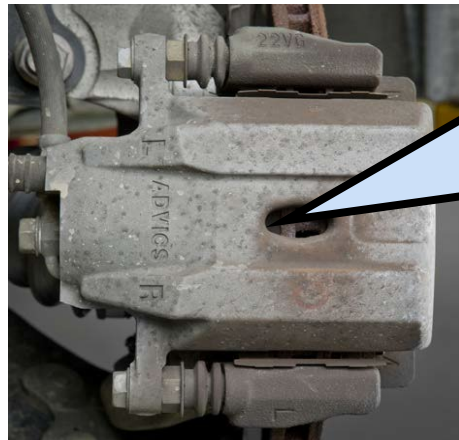

Brake Caliper Inspection Hole



Measuring inner brake pad



Measuring outer brake pad



PAD WEAR

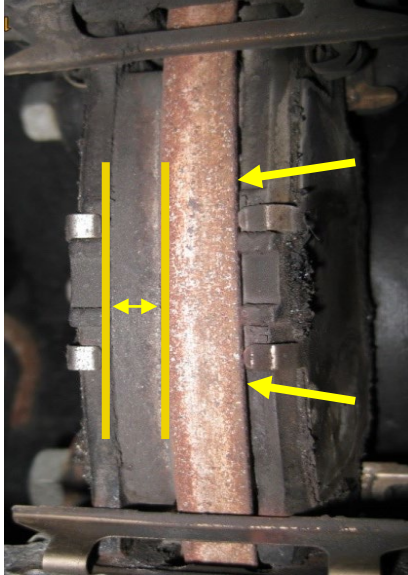

Unequal Wear

Unequal Pad Wear is a difference in lining thickness from inner to outer pads on the same brake assembly.

When unequal wear is found, inspect for sticking caliper slide pins, caliper piston, or pads seized in the support plates.



Tapered Wear

Tapered Wear is a difference in lining thickness between the top and bottom or between the left and right sides of a pad.

When tapered wear is found, inspect the brakes for sticking slide pins, disc runout, axle hub bearing looseness, or some other cause of the tapered wear.



Example of leaking caliper

Pad Glazing

- Examine pads for signs of glazing (unusually shiny friction surface)
- Replace the pads if they are glazed

Calipers

- Check caliper assembly for leakage, missing components, or inoperability
- Check piston for rust or scoring
- Check dust boot for cracks, leaks or deterioration

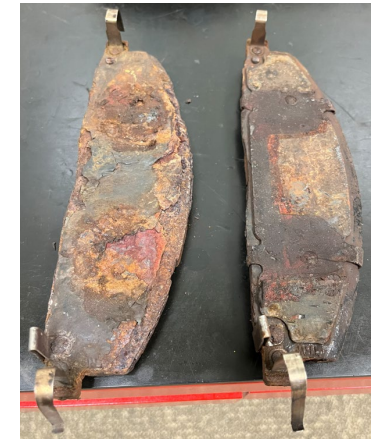

Rusted/deteriorated brake pad shims

Brake Pad Shims

- Check for rust and deterioration
- Rusted shims can cause a low, soft brake pedal feel condition
- Rusted shims may create abnormal noise conditions
- To fully inspect the brake pad shims, removal of the caliper may be necessary

DISC INSPECTION

- When inspecting the disc, check for excessive discoloration, rust, scoring or uneven wear
- The disc should be uniformly shiny from the inside to the outer edge, with no rust or signs of glazing, hot spots, and no visible cracks
- If you see slight lines in the disc braking surface, use the back of your fingernail to drag across the disc to check for scoring. There should not be any feel of scoring
- If there is excessive wear, measure disc thickness and runout



Visible cracking of the disc



Disc with hot spots



Scored Disc



HINT: The disc may also be referred to as a rotor.

DISC MEASUREMENTS

DISC THICKNESS

Using a rotor (disc) micrometer, measure the disc thickness

- If the disc thickness is less than the minimum specified in the Repair Manual, replace the disc
- If a new disc is needed on one side of the axle, replace the disc on the other side as well

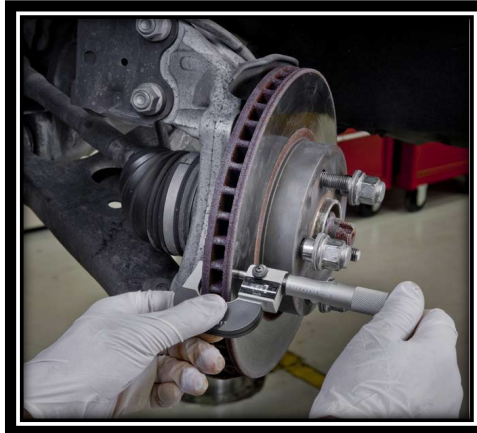

Measuring disc thickness with a micrometer

THICKNESS VARIATION

- When there is a brake vibration concern, measure the thickness at 8 equidistant points on the disc
- If the difference between any two measurements exceeds 0.02 mm (0.0008 in.), machine the disc or replace it

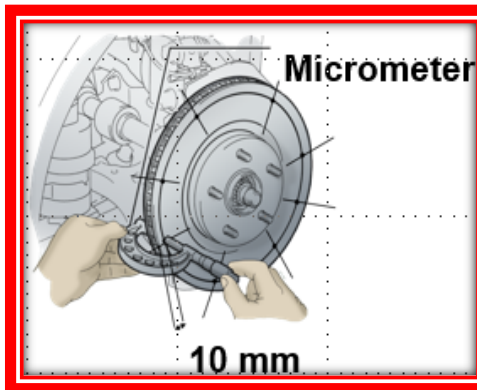

Measuring disc thickness variation

Thickness variation can be caused by:

- Improper wheel torque
- Wear from excessive disc runout
- Axle hub bearing looseness

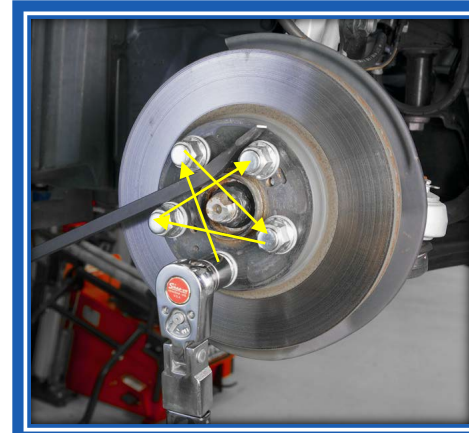

Torquing wheel nuts to measure runout

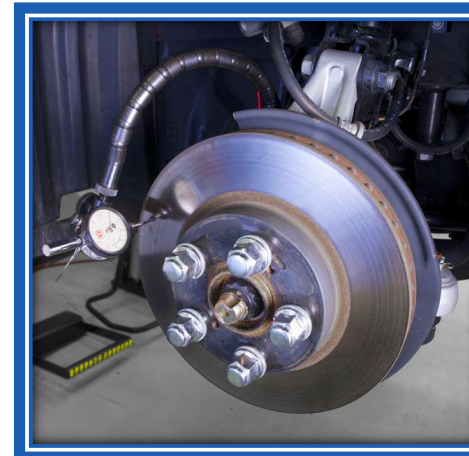

Measuring disc runout

Disc Runout

To measure disc runout:

- Use a suitable tool to hold the disc, then tighten the wheel nuts in a star pattern, and torque to specifications
- If the runout exceeds the specification in the Repair Manual, remove the disc and remove any corrosion from the mounting surfaces with a hub cleaning tool
- If there is no corrosion or debris, change the installation position of the disc to minimize the runout and measure again
- If the runout exceeds the maximum after the installation position is changed, measure hub flange runout
- If hub flange is within specification, machine the disc with an on-car brake lathe
- After machining, if the disc thickness is less than the minimum, replace the disc

Record the disc "Before" measurements on the back of the paper Repair Order or in the notes section of the Electronic Repair Order. "After" measurements may be required for certain warranty repairs. Refer to Toyota Warranty Policy and Procedures for details.

VISUAL INSPECTION

BRAKE DRUM

- Check for excessive discoloration, hot spots, scoring, rust or uneven wear



Minor discoloration of brake drum is ok

BRAKE LININGS

- Check for uneven wear, cracking, or signs of glazing (unusually shiny friction surface)
- Also check for contaminated brake lining due to either a leaking wheel cylinder or an axle seal



Lining contaminated with axle lubricant

WHEEL CYLINDERS

- Check for leakage, cracked boots, corrosion, also check for a seized piston



Inspecting for wheel cylinder leakage



Lining contaminated with brake fluid

ADJUSTER

- Check for broken or damaged components, corrosion or inoperative condition

RETURN SPRING

- Check for excessively rusted, stretched, bent, or broken springs

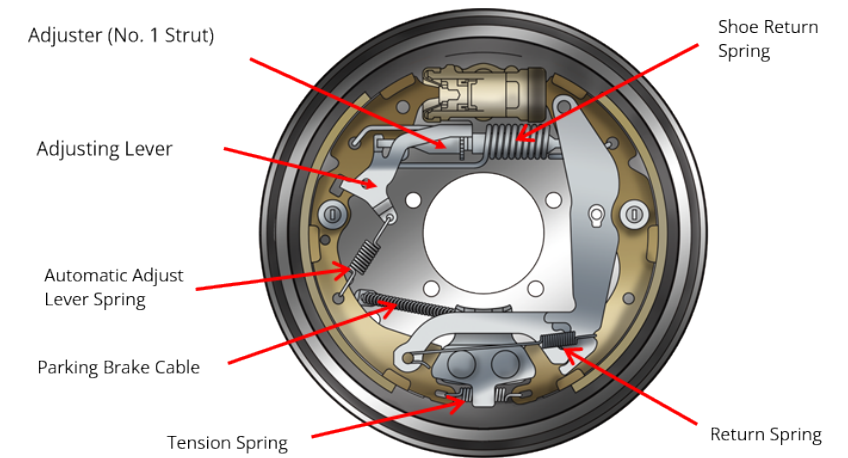

MEASUREMENTS

BRAKE DRUM

Inside Diameter: Using a brake drum gauge or equivalent, measure the inside diameter of the drum.

- If the diameter is greater than the Repair Manual specification, replace the drum

Out of Round: Check with a drum micrometer.

- If the drum is out of round by 0.0508 mm (0.002 in) or more replace the drum
- If a new drum is needed on one side of the axle, replace the drum on the other side as well

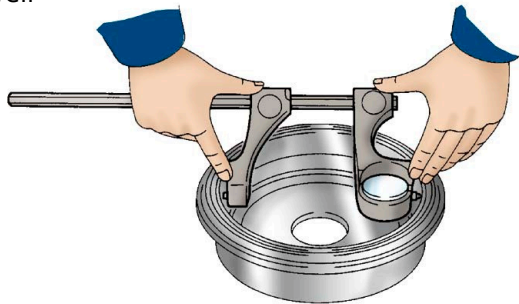

Measuring brake drum with a drum micrometer

- Record the drum brake "Before" measurements on the back of the paper Repair Order or in the notes section of the Electronic Repair Order, and on the MPI Sheet. "After" measurements may be required for certain warranty repairs. Refer to Toyota Warranty Policy and Procedures for details

BRAKE LININGS

Use a ruler or brake lining thickness gauge to measure the thickness of the lining material.

- Measure the lining only. Do not include the metal backing in the measurement
- If the thickness is less than 1.0 mm, or if the lining shows signs of uneven wear or glazing, replace the brake shoes



Measuring brake lining with thickness gauge



Measuring brake lining with steel ruler

INSPECT AND ADJUST BRAKE PEDAL HEIGHT

Measure the shortest distance between the brake pedal pad surface and floor panel. (Turn back the carpet if necessary)-Refer to the Repair Manual for complete procedure.

- If the pedal height differs from the specification in the Repair Manual, adjust the push rod length at the clevis

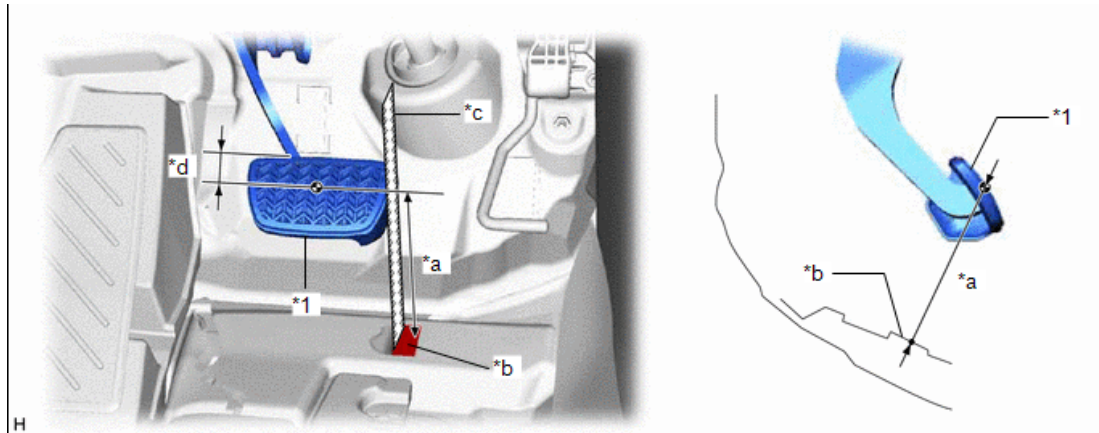

*1	Brake Pedal Pad	-	-
*a	Brake Pedal Height	*b	Measuring Plane of Floor Panel
*c	Ruler	*d	41 mm (1.61 in.)

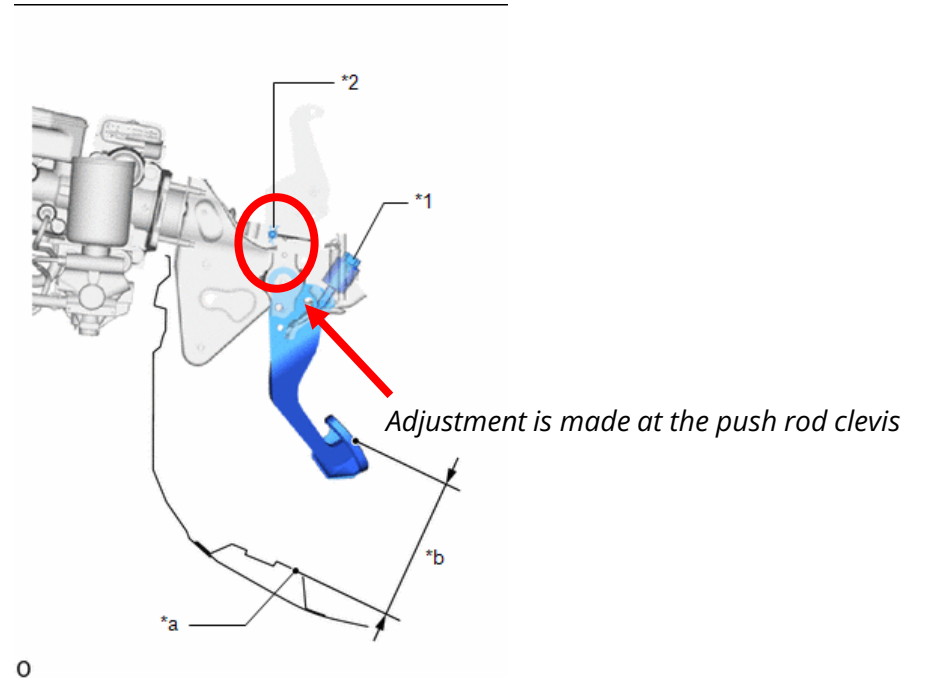

*1	Stop Light Switch Assembly
*2	Lock Nut
*a	Measuring Plane of Floor Panel
*b	Brake Pedal Height



HINT: Verify the pedal height is correct before measuring freeplay and reserve distance.

INSPECT AND ADJUST BRAKE PEDAL STROKE SENSOR (FOR ELECTRIFIED POWERTRAIN VEHICLES)



HINT: This procedure is for HV, PHEV, BEV, and FCHV vehicles.

- Using GTS +, navigate to the data list for the brake pedal stroke sensor (varies by model)
- Inspect the Stroke Sensor voltage without depressing the brake pedal; compare to Repair Manual specification
- If the value is out of specification, adjustment is necessary

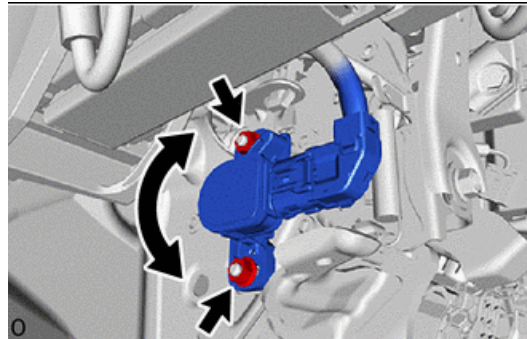

Brake Pedal Stroke Sensor Adjustment

- Adjustment is made by loosening the 2 nuts shown in the picture and turning the brake pedal stroke sensor until the voltage is within the specified range. Torque the 2 nuts according to specifications
- After Adjustment of the brake pedal stroke sensor, memory reset / calibration must be performed
- Refer to the Repair manual for the complete procedure

INSPECT AND ADJUST BRAKE PEDAL FREEPLAY

- For vehicles with a vacuum brake booster, turn off the engine and firmly depress the brake pedal several times to deplete the vacuum
- Depress the pedal until a slight resistance is felt. Measure the distance as shown in the illustration
- If the pedal freeplay is not as specified, check the stop light switch clearance

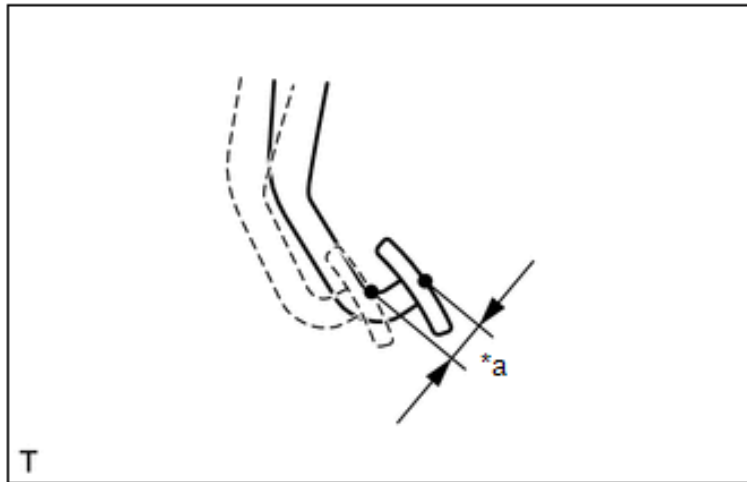

T

*a	Brake Pedal Free Play
----	-----------------------

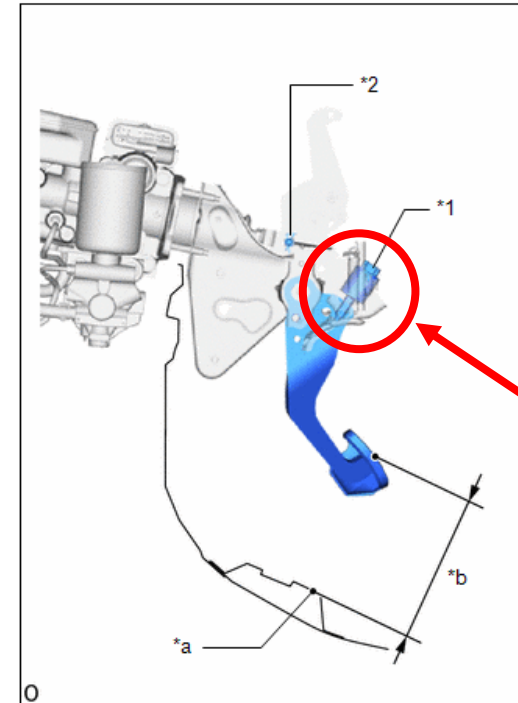

Adjust stoplight clearance at the stoplight switch to correct freeplay

*1	Stop Light Switch Assembly
*2	Lock Nut
*a	Measuring Plane of Floor Panel
*b	Brake Pedal Height

INSPECT BRAKE PEDAL RESERVE DISTANCE

Release the parking brake. With the engine running, (READY on) depress the brake pedal and measure the pedal reserve distance (Measure the distance at the same point used for the brake pedal height inspection)

- Use a pedal force gauge during this measurement to apply the amount of force specified in the Repair Manual
- If the distance is not as specified, troubleshoot the brake system



Brake Pedal Force Gauge SST P/N 09709-00002

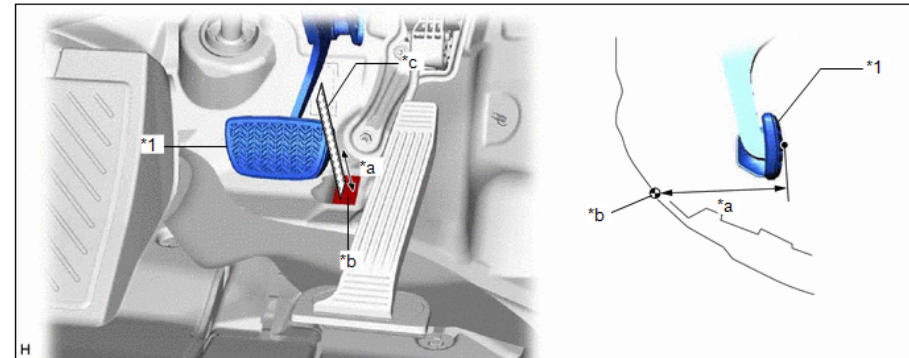

*1	Brake Pedal Pad	-	-
*a	Brake Pedal Reserve Distance	*b	Measuring Plane of Floor Panel
*c	Ruler	-	-

Possible causes of low reserve distance

- Fluid leak in system
- Air in brake system
- Rear shoe (Drum) adjustment
- Faulty master cylinder
- Faulty brake booster
- Incorrect booster pushrod length
- Others

PARKING BRAKE PEDAL / LEVER TRAVEL

- At a slow rate, fully apply the parking brake by pushing on the pedal or pulling the lever at the specified force amount found in the Repair Manual
- Use SST P/N 09709-00002 when applying the brake pedal to measure the application force
- Use a pull type force gauge when pulling the lever to measure the application force
- Count the number of clicks necessary to achieve the force applied
- Compare to specification in the Repair Manual
- If the travel is out of specification refer to the Repair Manual for adjustment procedure (varies by model)
- If equipped with a parking brake warning light, verify that the light illuminates on the first click



Brake Pedal Force Gauge SST P/N 09709-00002



Commercially available pull type force gauge



Foot Pedal for Parking Brake



Hand Pull Lever for Parking Brake

ELECTRIC PARKING BRAKE (EPB)

When the brake pads require service, the caliper piston will need to be retracted to allow for brake pad replacement. There are models that have a service mode available to retract the piston. Here are two methods available to perform this process.

- One uses GTS+ utilizing the menus Chassis> Brake> Utility> EPB Full Release
- The other is a manual method interacting with the EPB switch-Refer to the Repair Manual for correct sequence
- For models that **do not** have a service mode available there is a manual process that requires the use of a special service tool to retract the brake caliper piston-Refer to the Repair Manual for the complete procedure



GTS+



Electric Parking Brake Switch



Electric Parking Brake Caliper