

<b>Last Modified:</b> 12-04-2024	6.11:8.1.0	<b>Doc ID:</b> RM100000002B6LM
<b>Model Year Start:</b> 2023	<b>Model:</b> Prius Prime	<b>Prod Date Range:</b> [03/2023 - ]
<b>Title:</b> INTERIOR PANELS / TRIM: FRONT CONSOLE BOX: REMOVAL; 2023 - 2024 MY Prius Prius Prime [03/2023 - ]		

## REMOVAL

### CAUTION / NOTICE / HINT



#### NOTICE:

- When disconnecting a wire harness of any component connected to the supply power of the integrated capacitor (integration control supply) or when removing the integrated capacitor (integration control supply), make sure to wait 5 minutes or more after turning the ignition switch off for self-diagnosis to complete and the voltage of the integrated capacitor (integration control supply) to discharge.
- After completing a procedure, change the shift position to all positions and check the following items:
  - The shift position indicator illuminates in accordance with the current position
  - The vehicle does not move when in shift state P (parking brake is not engaged)
  - The vehicle does not drive when in shift state N
  - The vehicle drives when in shift state D or R

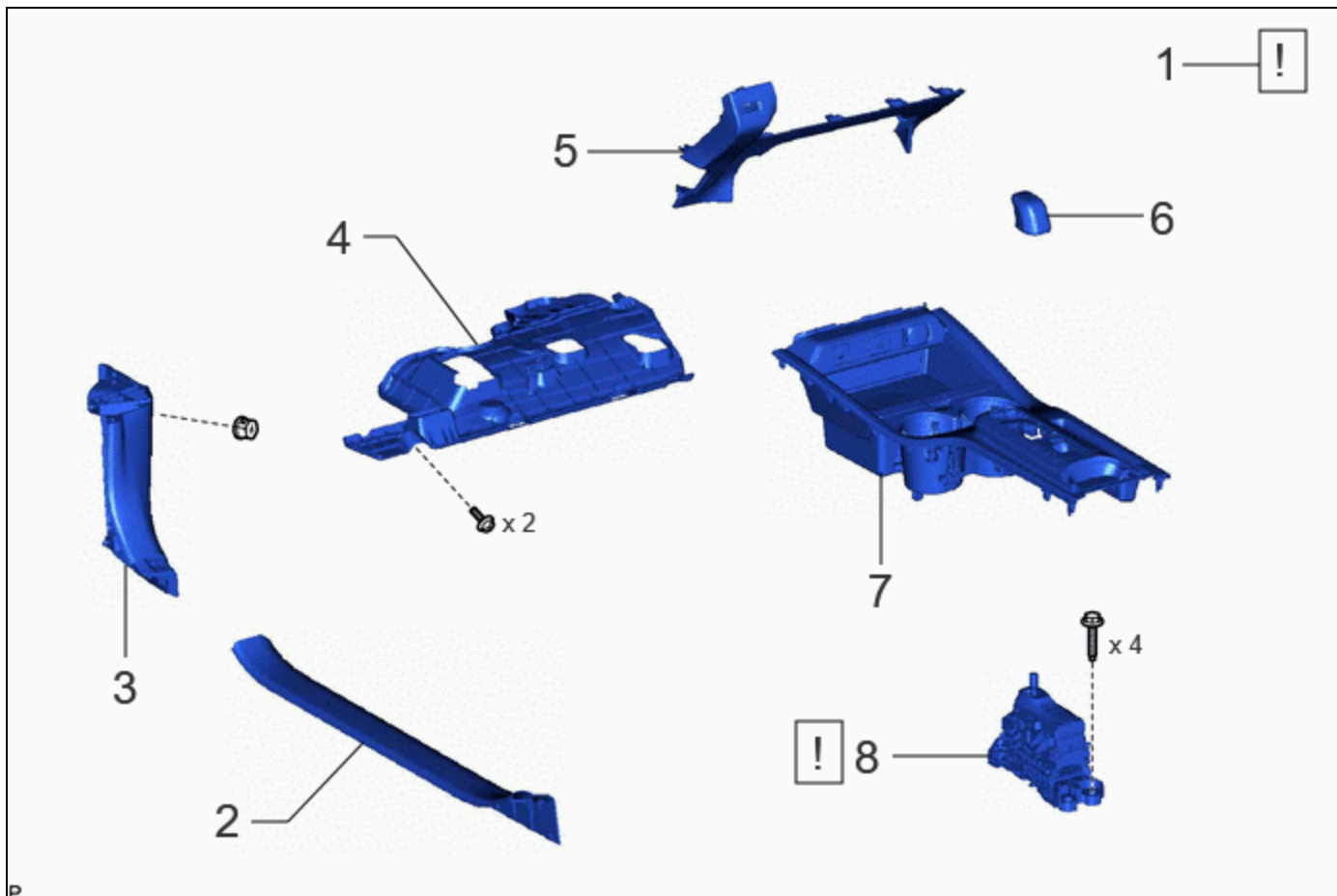

### CAUTION / NOTICE / HINT



#### COMPONENTS (REMOVAL)

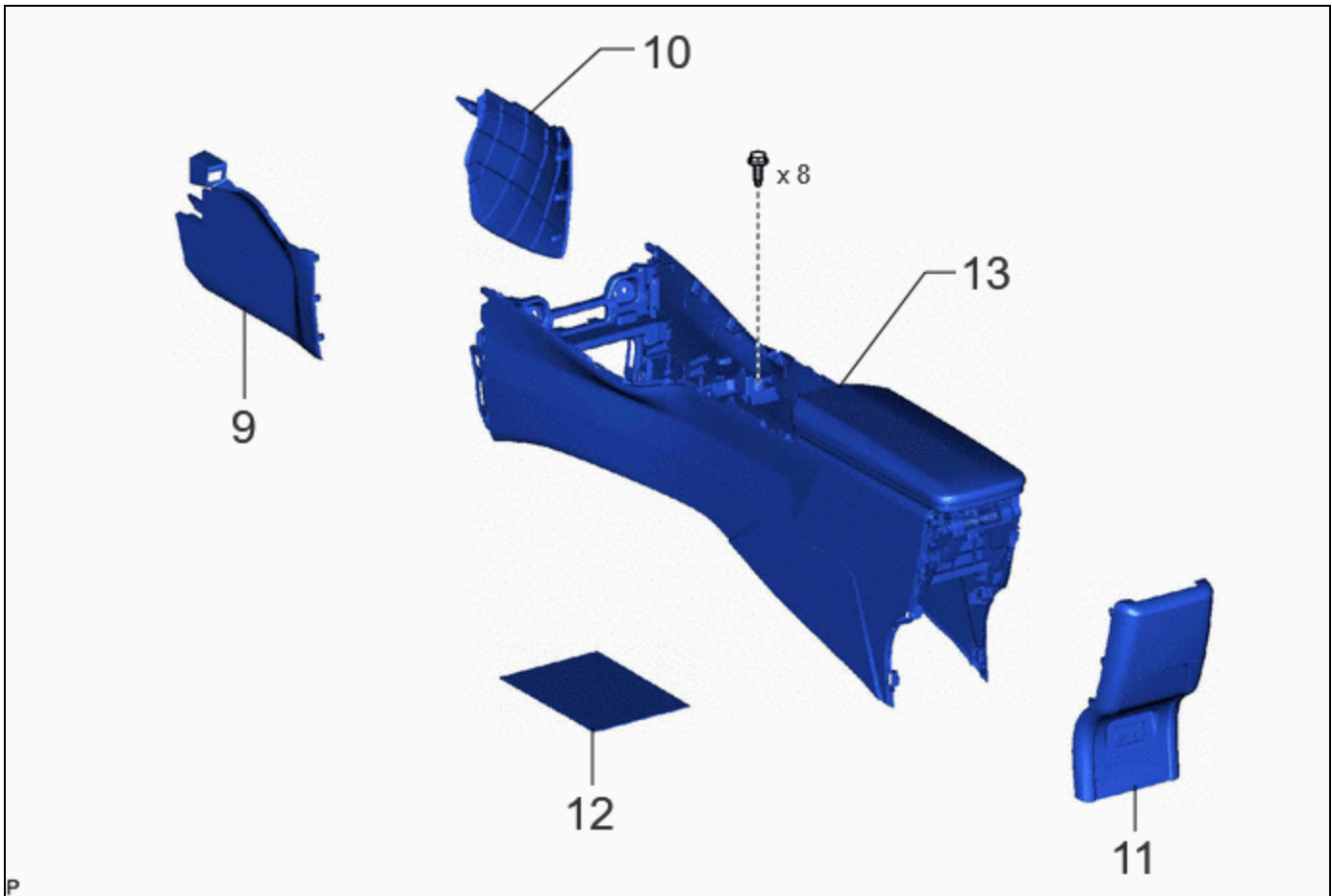





PROCEDURE		PART NAME CODE			
1	SECURE VEHICLE	-	INFO	-	-
2	FRONT DOOR SCUFF PLATE LH	67914	-	-	-
3	COWL SIDE TRIM BOARD LH	62112	-	-	-
4	NO. 1 INSTRUMENT PANEL UNDER COVER SUB-ASSEMBLY	55606	-	-	-
5	LOWER CENTER INSTRUMENT PANEL FINISH PANEL	55434B	-	-	-
6	SHIFT LEVER KNOB SUB-ASSEMBLY	33504F	-	-	-
7	UPPER CONSOLE PANEL SUB-ASSEMBLY	58804A	-	-	-
8	TRANSMISSION FLOOR SHIFT ASSEMBLY	33550	INFO	-	-

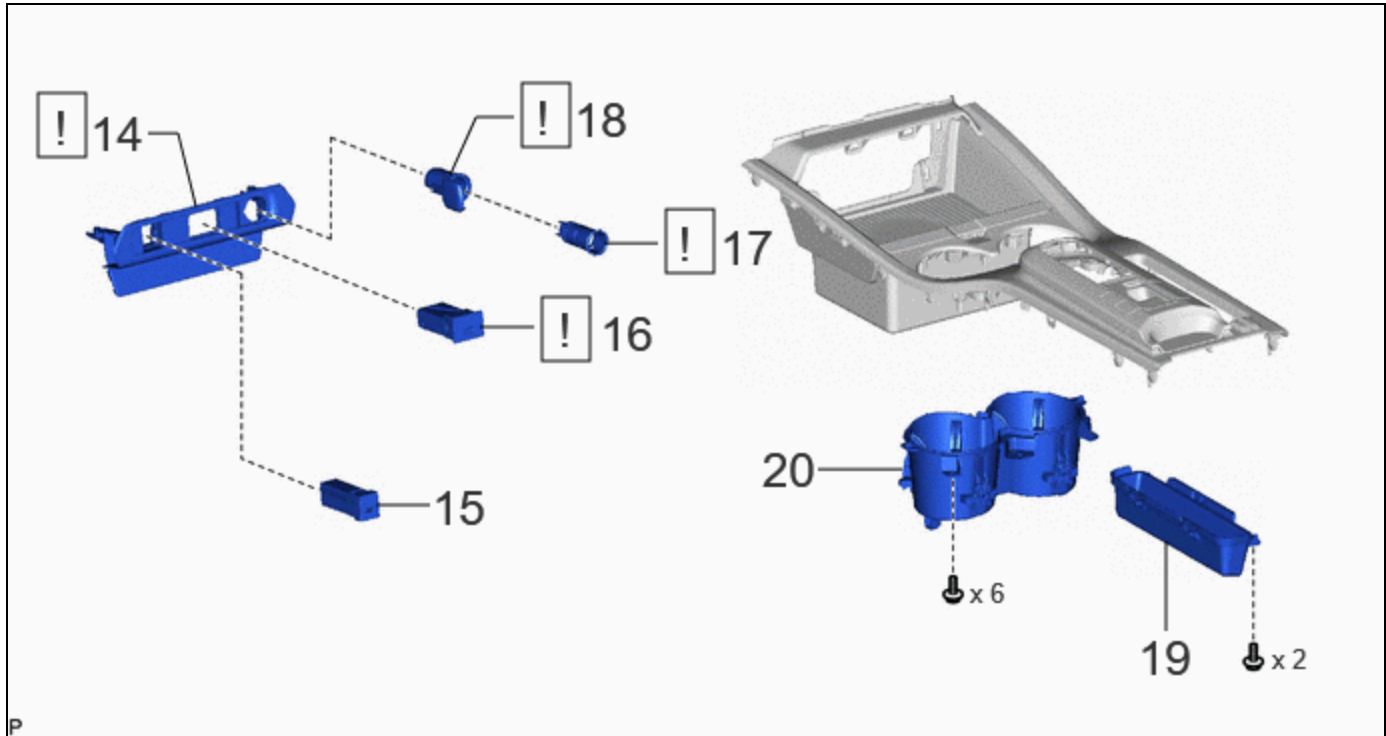

PROCEDURE		PART NAME CODE			
9	FRONT NO. 1 CONSOLE BOX INSERT	58816D	-	-	-
10	FRONT NO. 2 CONSOLE BOX INSERT	58817A	-	-	-
11	CONSOLE REAR END PANEL SUB-ASSEMBLY	58903A	-	-	-

PROCEDURE		PART NAME CODE			
12	CONSOLE BOX CARPET	58815A	-	-	-
13	REAR CONSOLE BOX ASSEMBLY	58910C	-	-	-



PROCEDURE		PART NAME CODE			
14	FRONT CONSOLE BOX COVER	58818A	<a href="#">INFO</a>	-	-
15	STEREO JACK ADAPTER ASSEMBLY	86190E	-	-	-
16	USB CHARGER SOCKET	85532	<a href="#">INFO</a>	-	-
17	NO. 1 POWER OUTLET SOCKET ASSEMBLY	85530	<a href="#">INFO</a>	-	-
18	NO. 1 POWER OUTLET SOCKET COVER	85535B	<a href="#">INFO</a>	-	-
19	CONSOLE BOX POCKET	-	-	-	-
20	CONSOLE CUP HOLDER BOX SUB-ASSEMBLY	58803C	-	-	-

## PROCEDURE

### 1. SECURE VEHICLE

	Click here <a href="#">INFO</a>
---	---------------------------------

**2. REMOVE FRONT DOOR SCUFF PLATE LH**

Click here [INFO](#)

**3. REMOVE COWL SIDE TRIM BOARD LH**

Click here [INFO](#)

**4. REMOVE NO. 1 INSTRUMENT PANEL UNDER COVER SUB-ASSEMBLY**

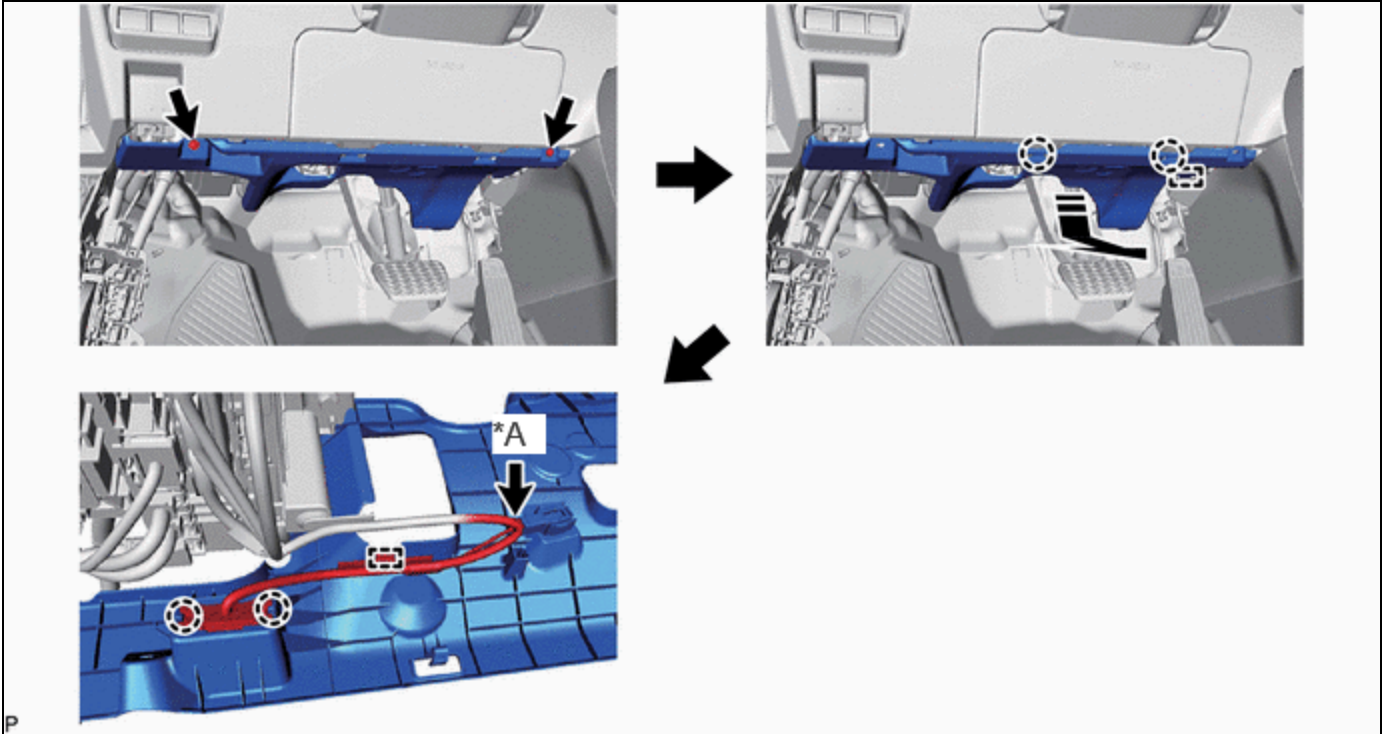

*A	w/ Illumination	-	-
	Remove in this Direction	-	-

**5. REMOVE LOWER CENTER INSTRUMENT PANEL FINISH PANEL**

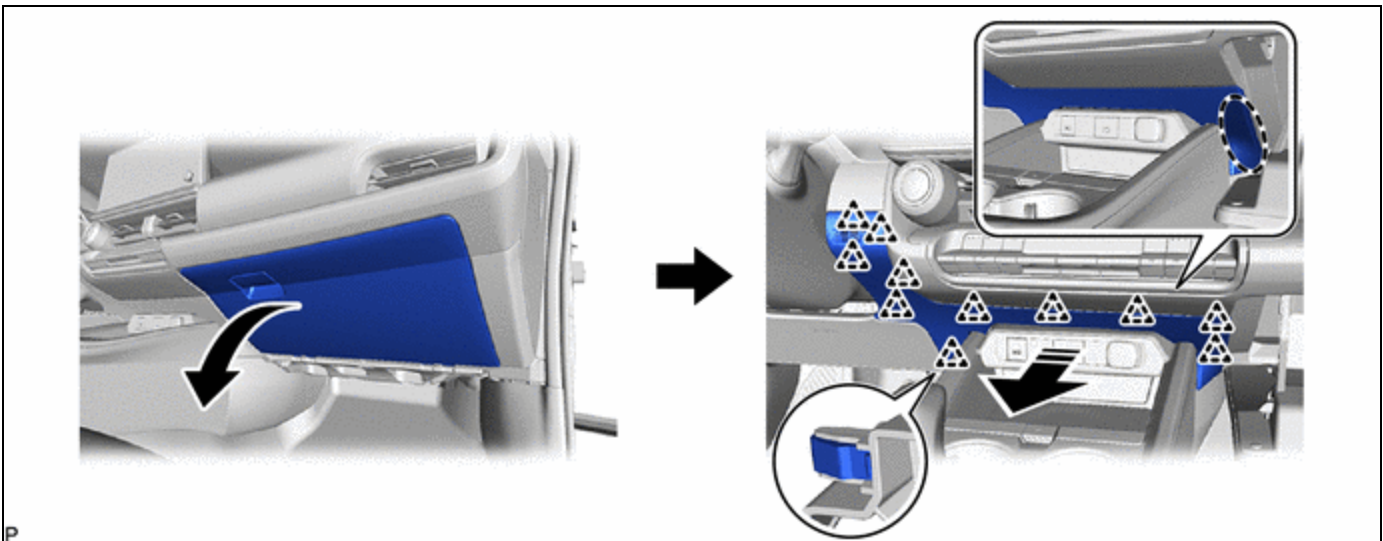

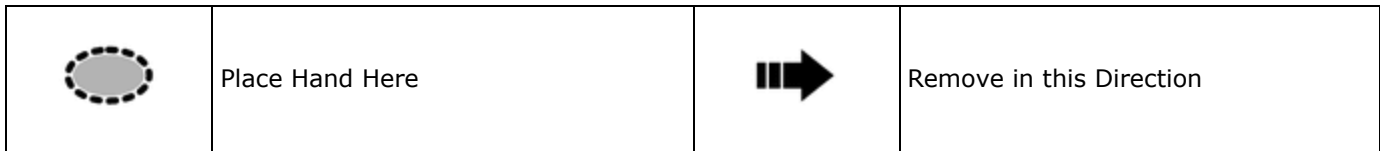

(b) w/ Knee Airbag:

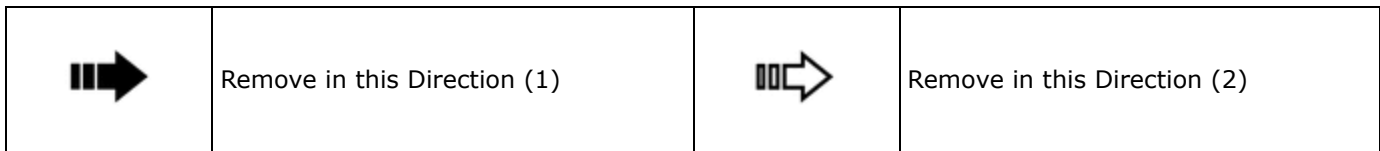
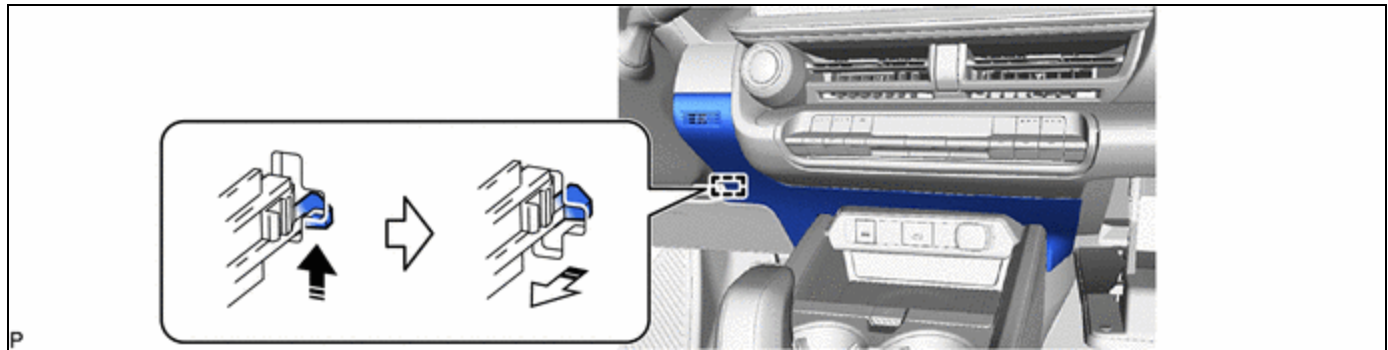

**6. REMOVE SHIFT LEVER KNOB SUB-ASSEMBLY**

Click here [INFO](#)

**7. REMOVE UPPER CONSOLE PANEL SUB-ASSEMBLY**

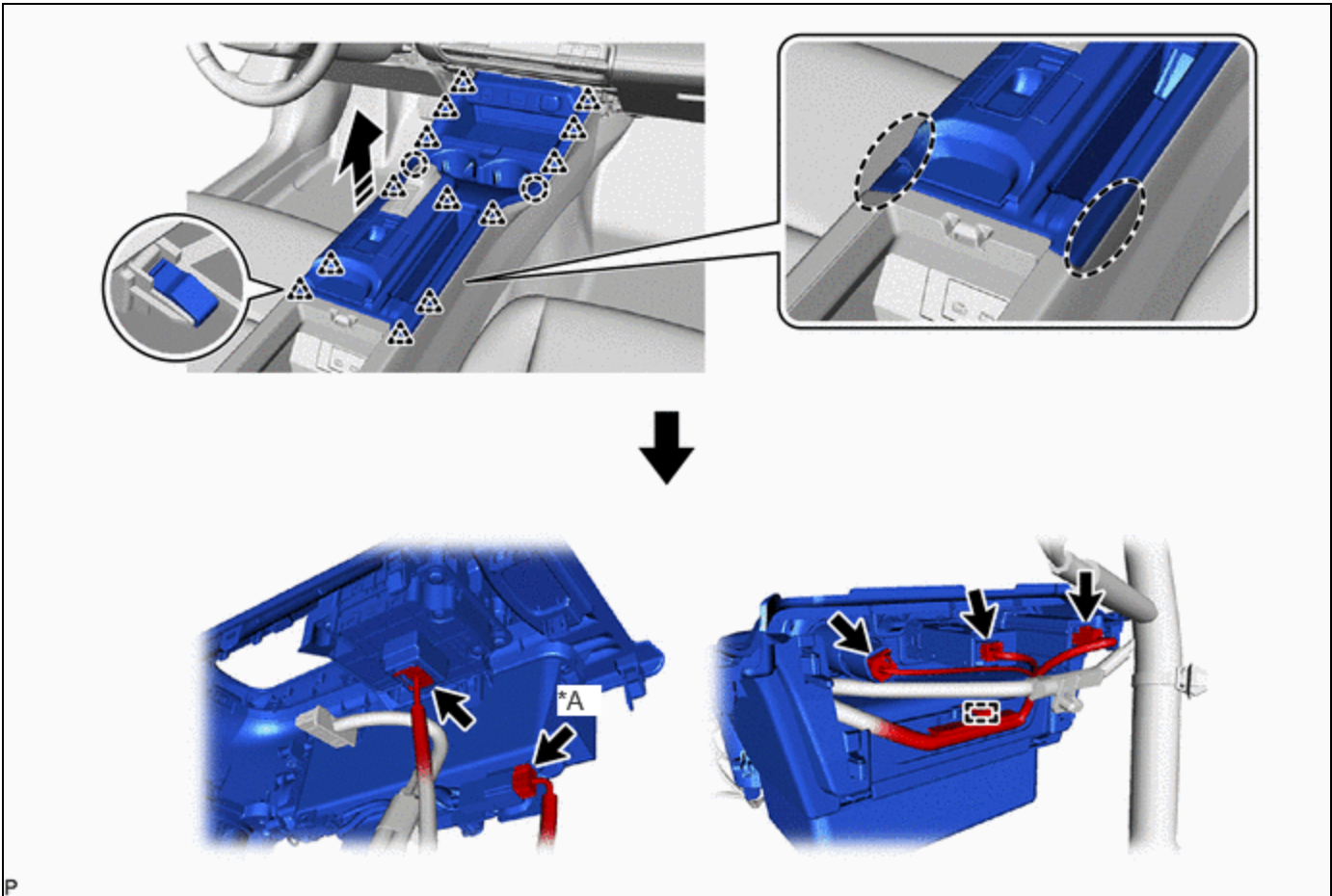
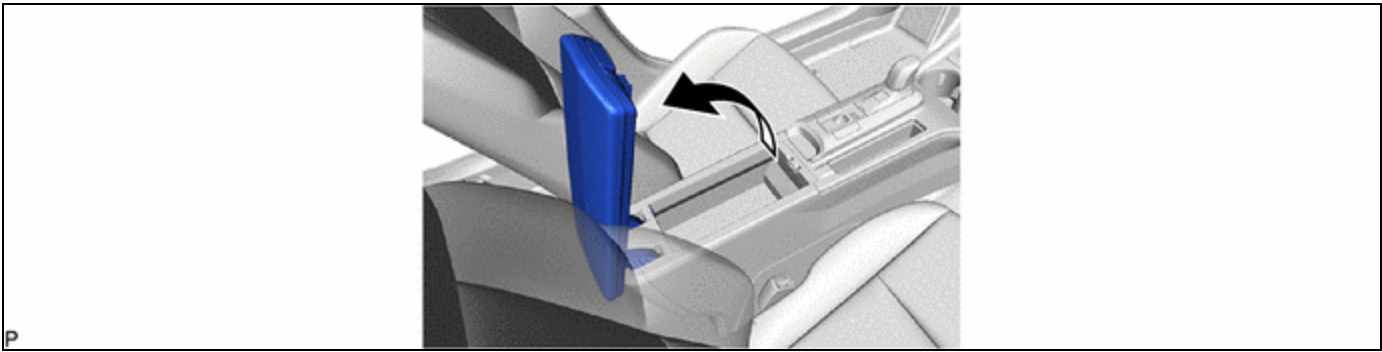



*A	w/ Wireless Charger	-	-
	Place Hand Here		Remove in this Direction

**8. REMOVE TRANSMISSION FLOOR SHIFT ASSEMBLY**

Click here [INFO](#)

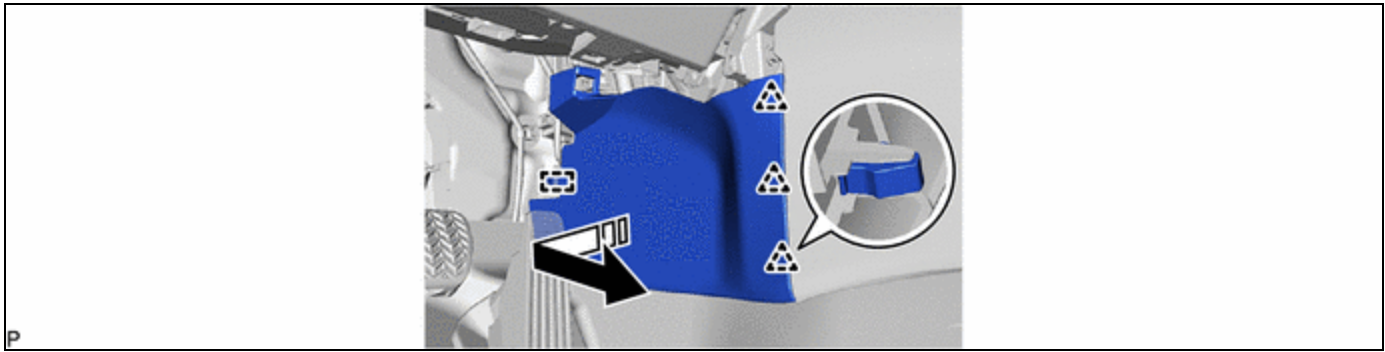
**9. REMOVE FRONT NO. 1 CONSOLE BOX INSERT**



	Remove in this Direction	-	-
---	--------------------------	---	---

**10. REMOVE FRONT NO. 2 CONSOLE BOX INSERT**

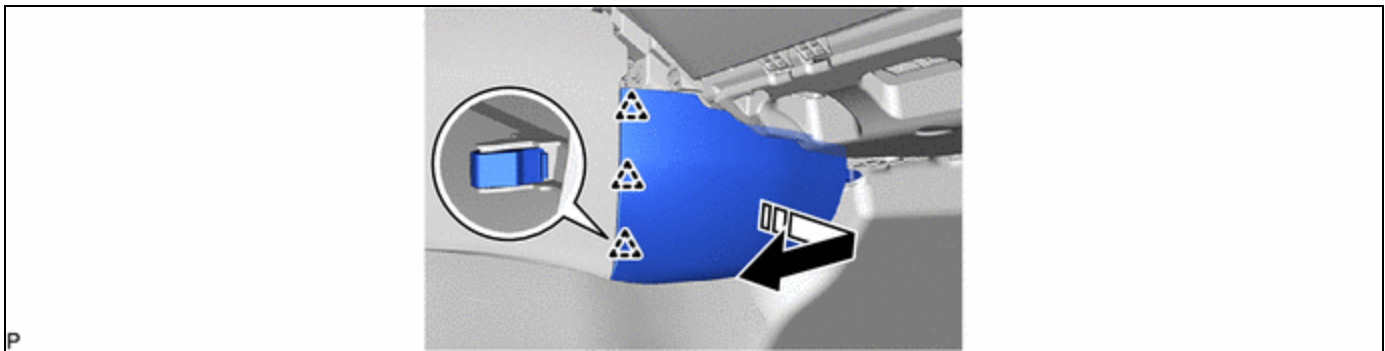

	Remove in this Direction	-	-
---	--------------------------	---	---

**11. REMOVE CONSOLE REAR END PANEL SUB-ASSEMBLY**

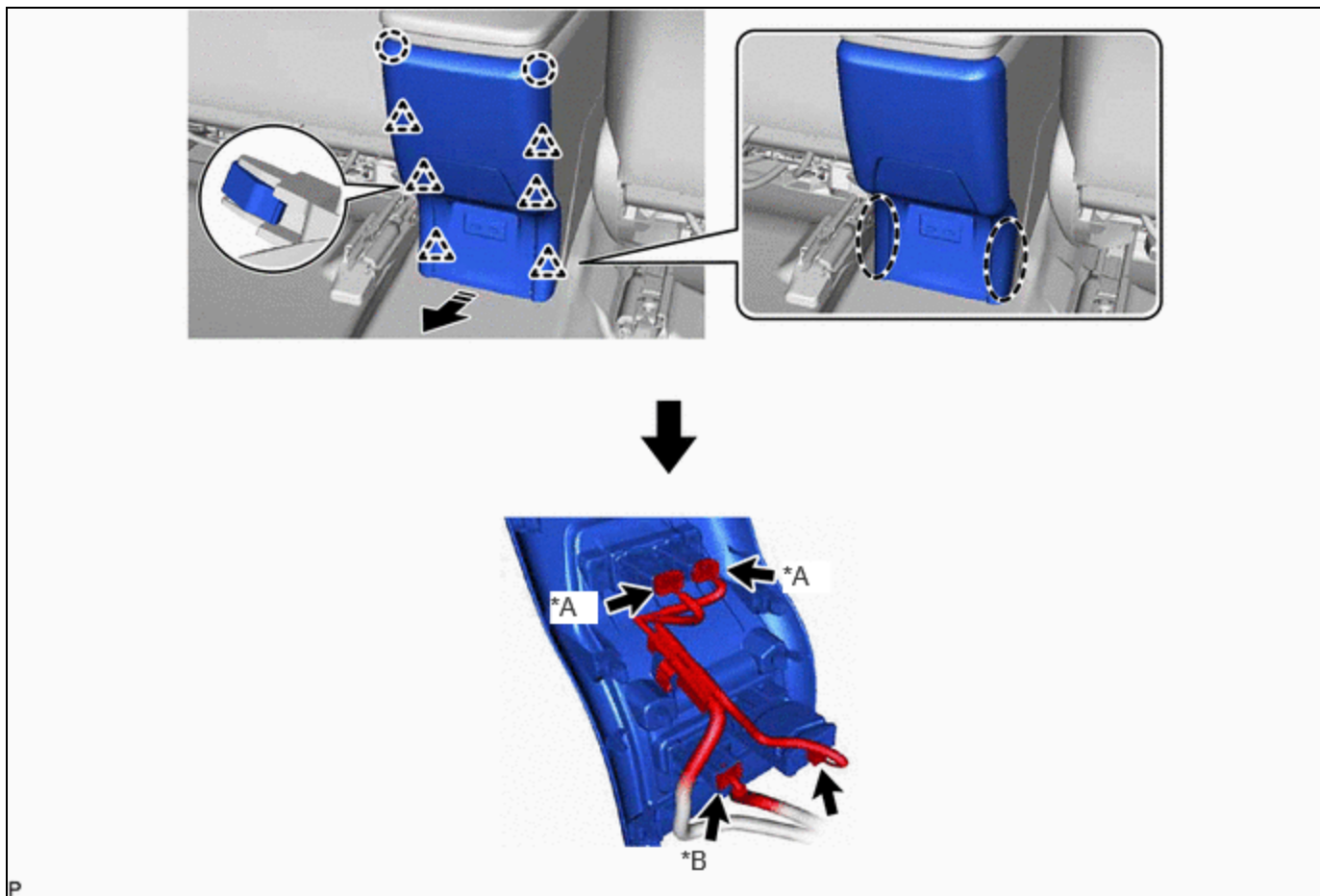

*A	w/ Seat Heater System	*B	w/ Power Outlet Socket
	Place Hand Here		Remove in this Direction

**12. REMOVE CONSOLE BOX CARPET**

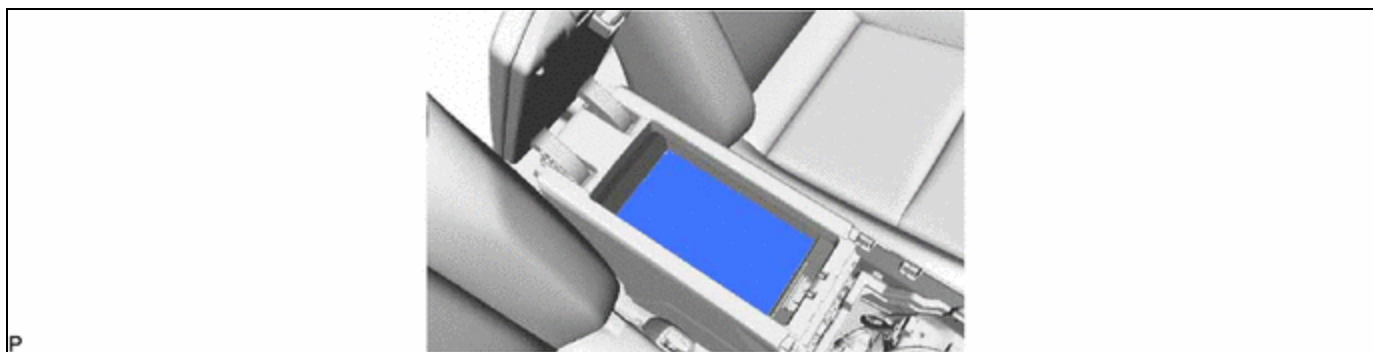

**13. REMOVE REAR CONSOLE BOX ASSEMBLY**



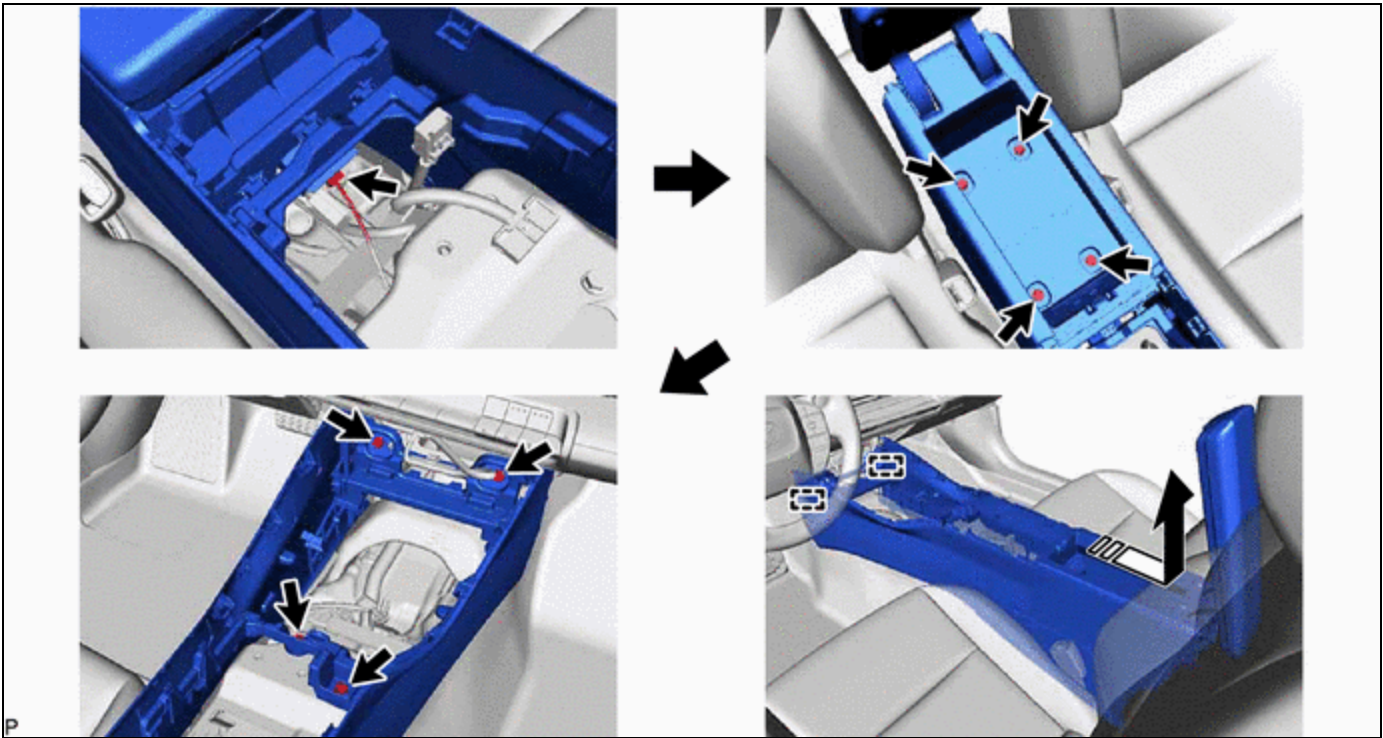

	Remove in this Direction	-	-
--	--------------------------	---	---

### 14. REMOVE FRONT CONSOLE BOX COVER

**HINT:**

Perform this procedure only when replacement of the front console box cover is necessary.

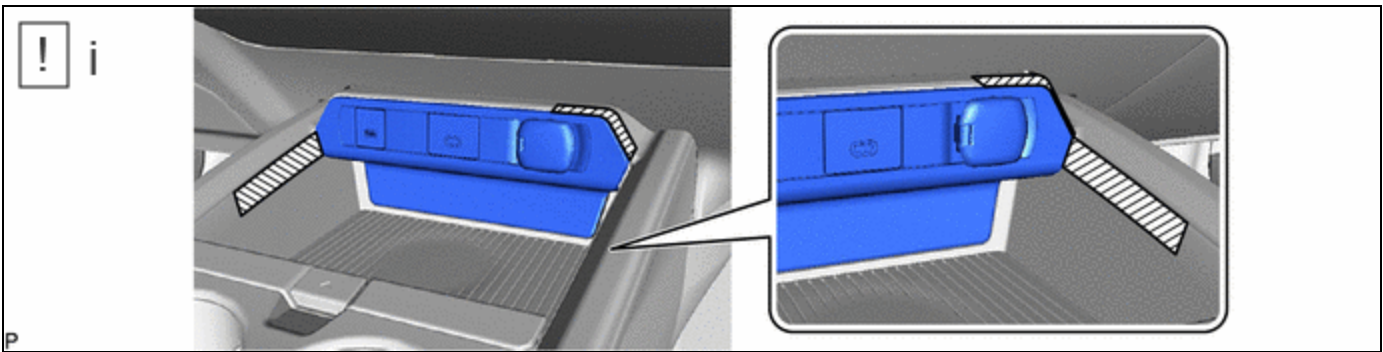

(1) Apply protective tape to the area shown in the illustration.

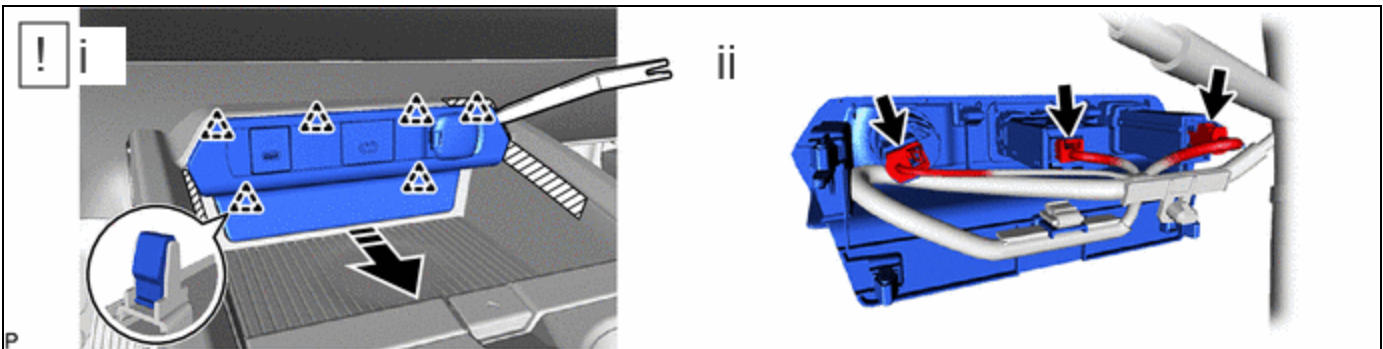

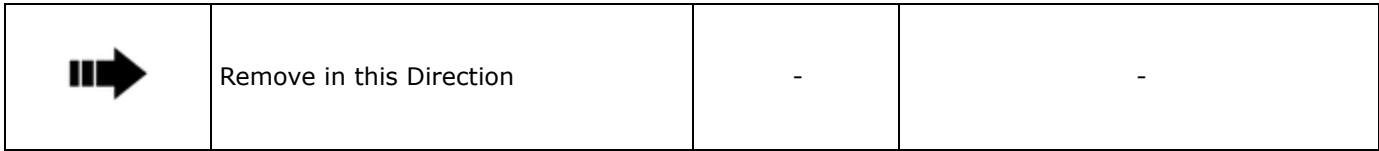

(1) Using a moulding remover, disengage the 6 clips as shown in the illustration to remove the front console box cover.

(2) Disconnect each connector.

### 15. REMOVE STEREO JACK ADAPTER ASSEMBLY

**HINT:**

Perform this procedure only when replacement of the front console box cover is necessary.

Click here [INFO](#)

### 16. REMOVE USB CHARGER SOCKET

**HINT:**

Perform this procedure only when replacement of the front console box cover is necessary.

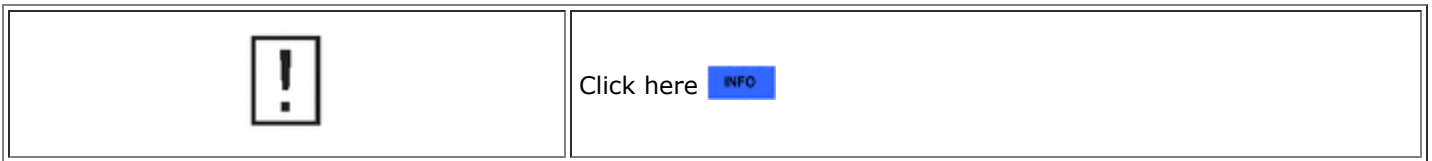

### 17. REMOVE NO. 1 POWER OUTLET SOCKET ASSEMBLY

**HINT:**

Perform this procedure only when replacement of the front console box cover is necessary.

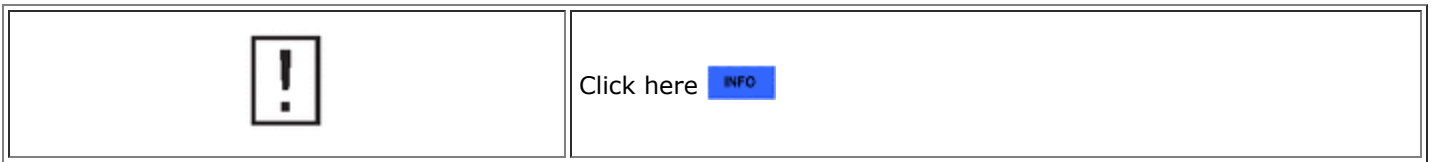

### 18. REMOVE NO. 1 POWER OUTLET SOCKET COVER

**HINT:**

Perform this procedure only when replacement of the front console box cover is necessary.

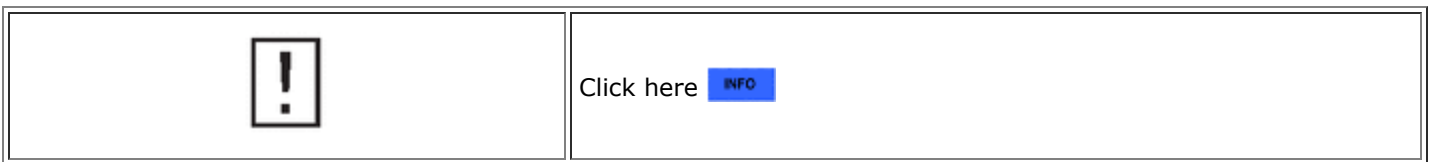

### 19. REMOVE CONSOLE BOX POCKET

**HINT:**

Perform this procedure only when replacement of the console box pocket is necessary.

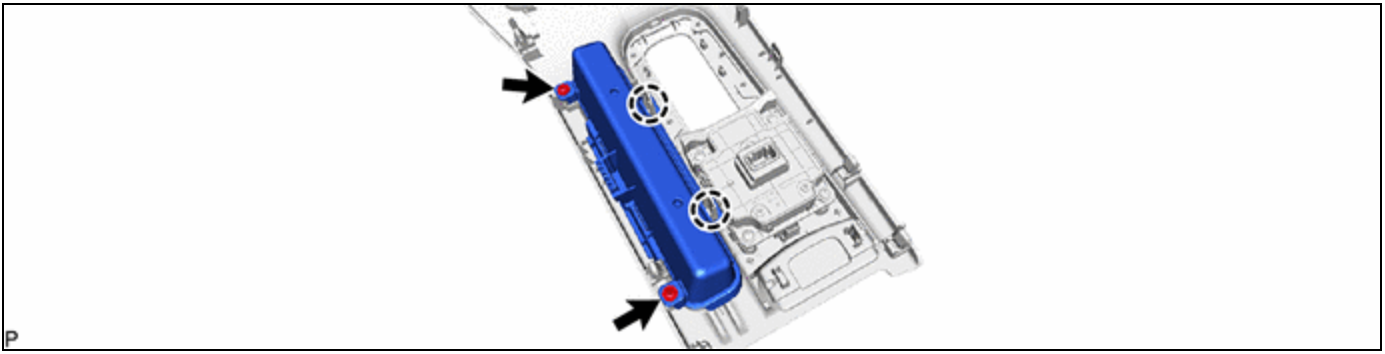

## 20. REMOVE CONSOLE CUP HOLDER BOX SUB-ASSEMBLY

**HINT:**

Perform this procedure only when replacement of the console cup holder box sub-assembly is necessary.

