

<b>Last Modified:</b> 12-04-2024	6.11:8.1.0	<b>Doc ID:</b> RM1000000029TP0
<b>Model Year Start:</b> 2023	<b>Model:</b> Prius Prime	<b>Prod Date Range:</b> [12/2022 - ]
<b>Title:</b> SEAT: FRONT SEATBACK HEATER (for Power Seat): INSTALLATION; 2023 - 2024 MY Prius Prius Prime [12/2022 - ]		

## INSTALLATION

### CAUTION / NOTICE / HINT

**CAUTION:**



Wear protective gloves. Sharp areas on the parts may injure your hands.



### CAUTION / NOTICE / HINT

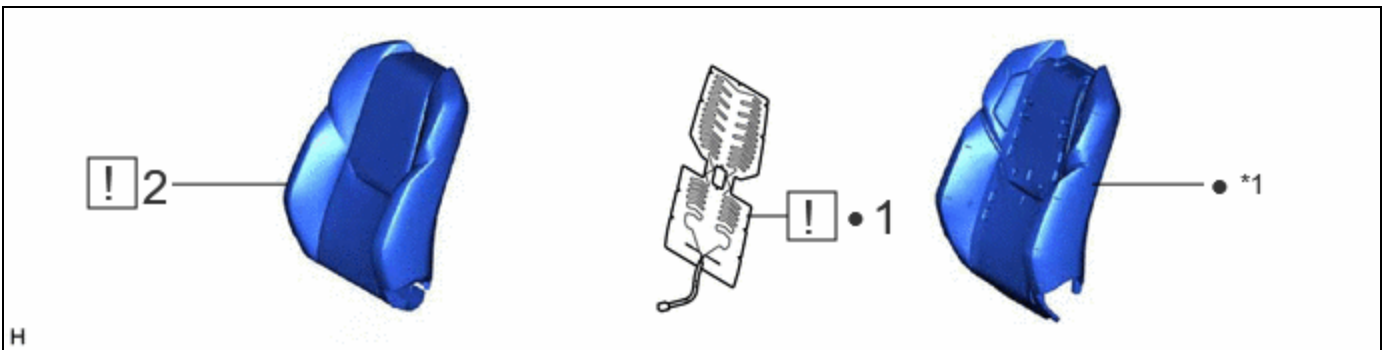

#### COMPONENTS (INSTALLATION)

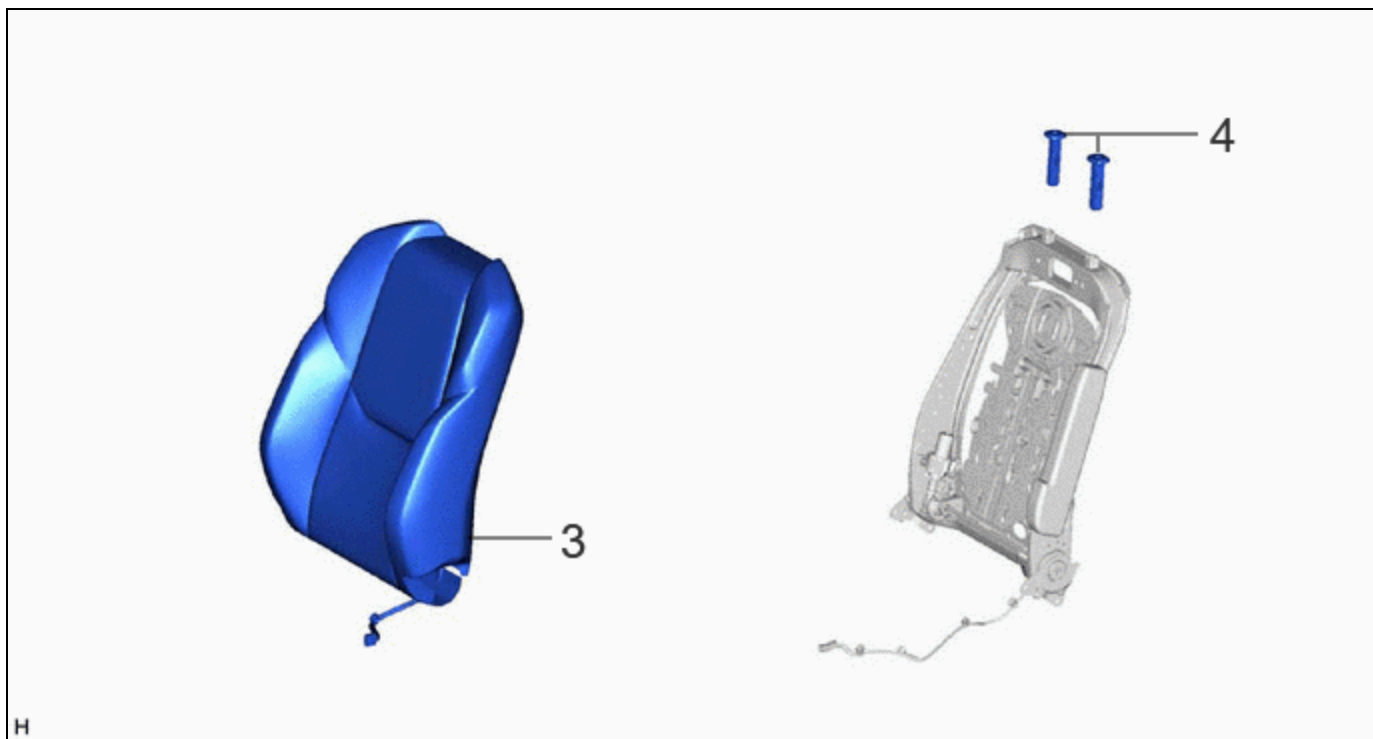

PROCEDURE		PART NAME CODE			
1	FRONT SEATBACK HEATER ASSEMBLY	87510N	<a href="#">INFO</a>	-	-
2	SEPARATE TYPE FRONT SEATBACK COVER	71074S	<a href="#">INFO</a>	-	-

*1	SEPARATE TYPE FRONT SEATBACK PAD	-	-
•	Non-reusable part	-	-



PROCEDURE		PART NAME CODE			
3	SEPARATE TYPE FRONT SEATBACK COVER WITH PAD	-	-	-	-
4	FRONT SEAT HEADREST SUPPORT	71931	-	-	-

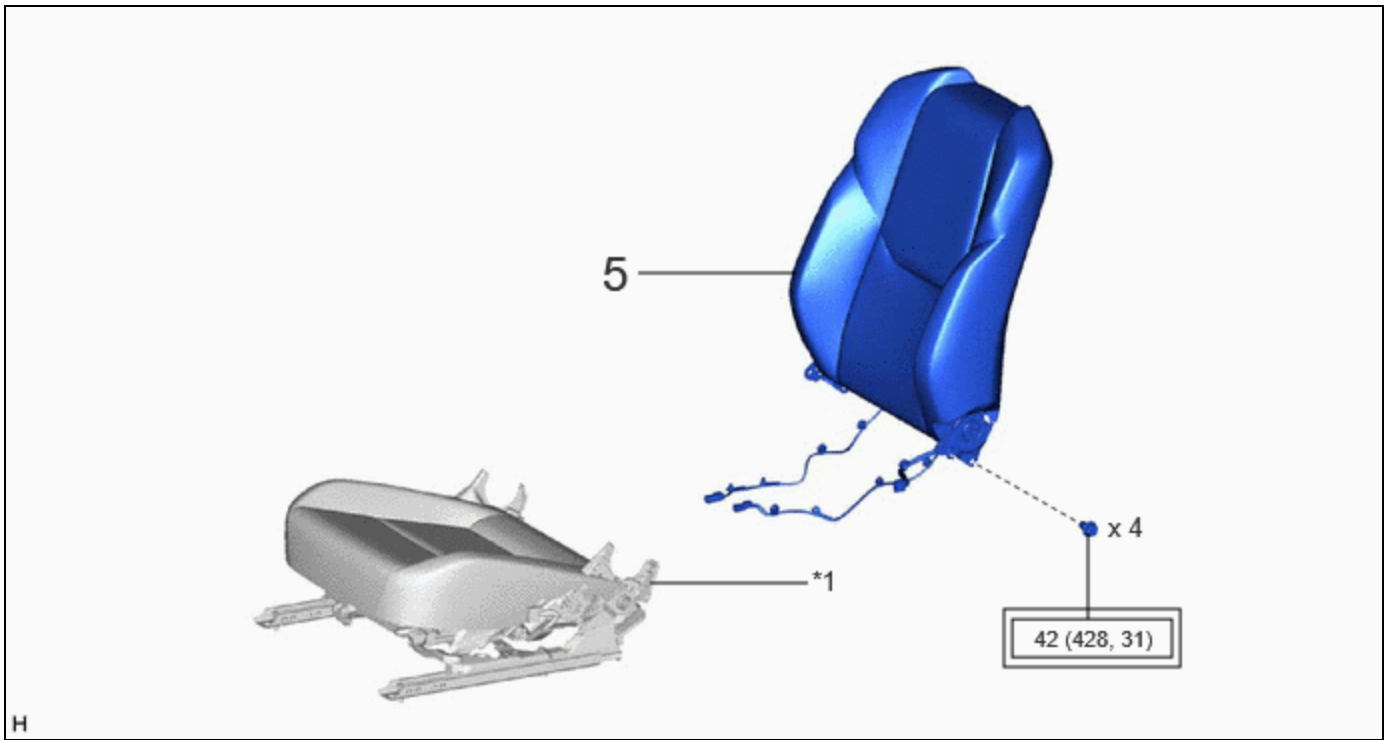

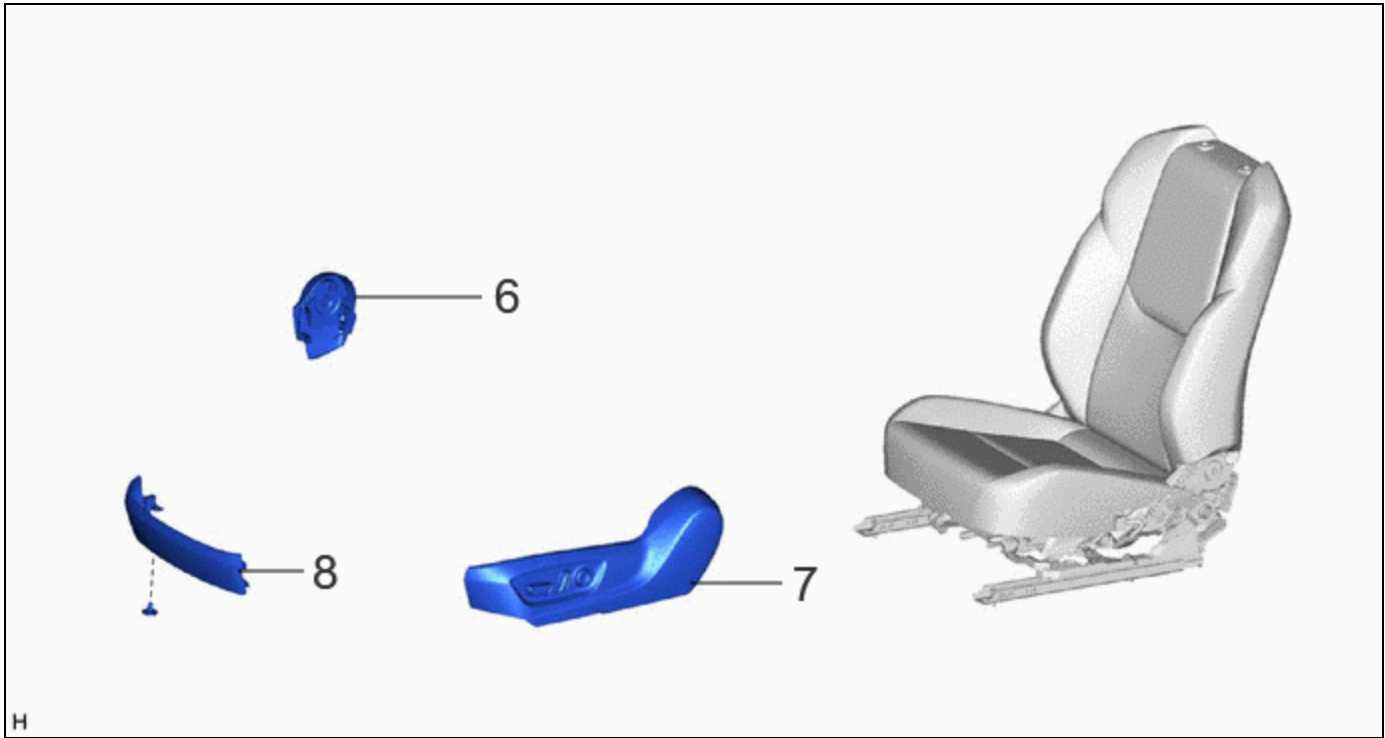

PROCEDURE	PART NAME CODE	!	✍️	⚙️
5 SEPARATE TYPE FRONT SEATBACK ASSEMBLY	-	-	-	-

*1	SEPARATE TYPE FRONT SEAT CUSHION ASSEMBLY	-	-
	Tightening torque for "Major areas involving basic vehicle performance such as moving/turning/stopping": N*m (kgf*cm, ft.*lbf)	-	-







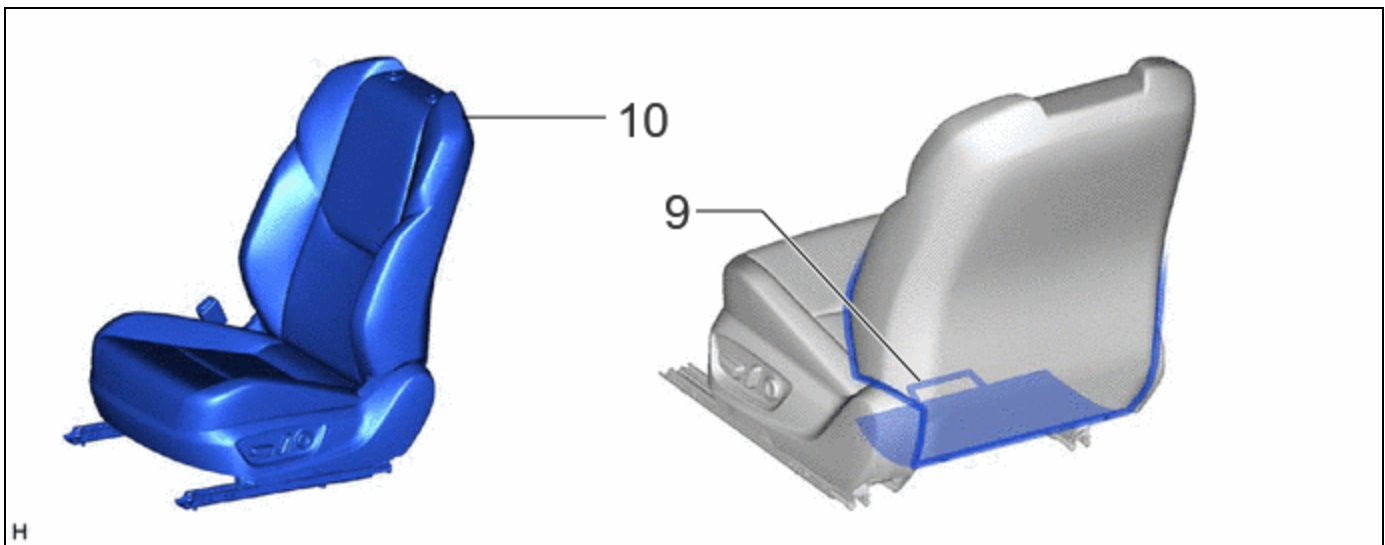

H

PROCEDURE		PART NAME CODE			
6	FRONT SEAT INNER CUSHION SHIELD	71862	-	-	-
7	FRONT SEAT CUSHION SHIELD	71812D	-	-	-
8	FRONT SEAT FRONT CUSHION SHIELD	71868N	-	-	-



H

PROCEDURE		PART NAME CODE			
9	CONNECT SEPARATE TYPE FRONT SEATBACK COVER	71074S	-	-	-

PROCEDURE		PART NAME CODE			
10	FRONT SEAT ASSEMBLY	-	-	-	-

## PROCEDURE

### 1. INSTALL FRONT SEATBACK HEATER ASSEMBLY

	<p><b>NOTICE:</b></p> <p>Replace the front seatback heater assembly and separate type front seatback pad as a set.</p>
---	--

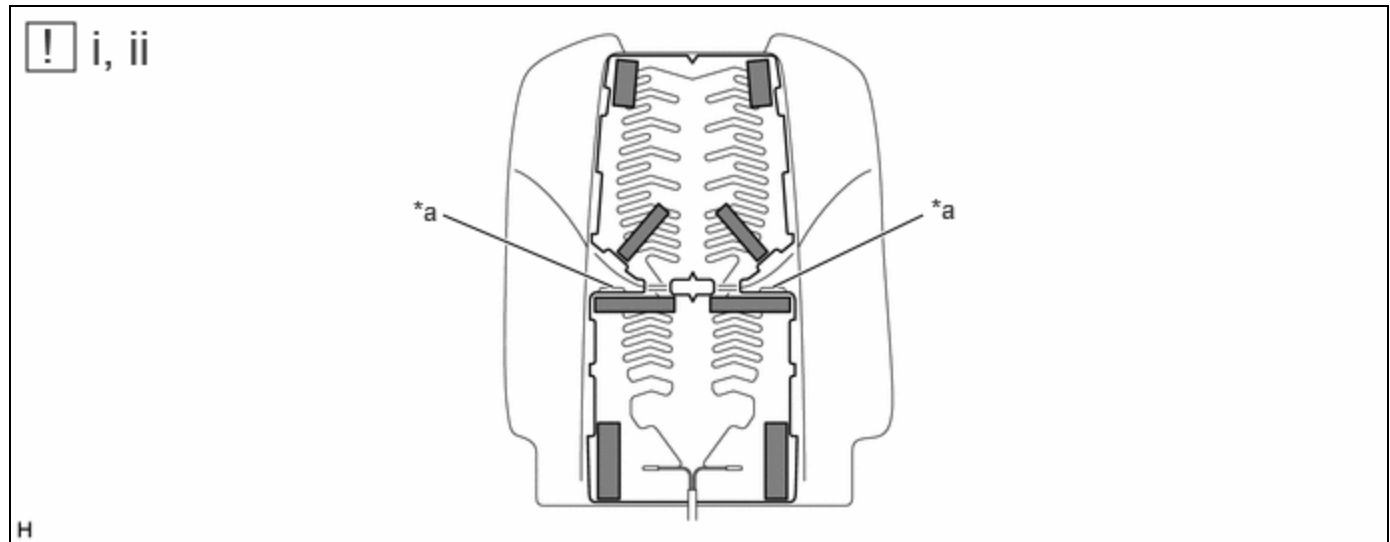

*a	Cutout	-	-
	Double-sided Tape	-	-

- (1) Remove the release paper from a new front seatback heater assembly.
- (2) Install the new front seatback heater assembly while aligning with the cutouts as shown in the illustration.

**NOTICE:**

Press the front seatback heater assembly firmly to install it.

### 2. INSTALL SEPARATE TYPE FRONT SEATBACK COVER

	<p>Click here <a href="#">INFO</a></p>
---	--

### 3. INSTALL SEPARATE TYPE FRONT SEATBACK COVER WITH PAD

### 4. INSTALL FRONT SEAT HEADREST SUPPORT

**5. INSTALL SEPARATE TYPE FRONT SEATBACK ASSEMBLY**

Click here 

**6. INSTALL FRONT SEAT INNER CUSHION SHIELD**

**7. INSTALL FRONT SEAT CUSHION SHIELD**

**8. INSTALL FRONT SEAT FRONT CUSHION SHIELD**

**9. CONNECT SEPARATE TYPE FRONT SEATBACK COVER**

**10. INSTALL FRONT SEAT ASSEMBLY**

Click here 

