

Last Modified: 12-04-2024	6.11:8.1.0	Doc ID: RM100000002C2EP
Model Year Start: 2023	Model: Prius Prime	Prod Date Range: [03/2023 -]
Title: MAINTENANCE: FRONT DISC BRAKE PAD: INSTALLATION; 2023 - 2024 MY Prius Prius Prime [03/2023 -]		

INSTALLATION

CAUTION / NOTICE / HINT

NOTICE:

- Immediately after installing the front disc brake pads, the braking performance may be reduced. Always perform a road test in a safe place while paying attention to the surroundings.
- After replacing the front disc brake pads, the brake pedal may feel soft due to clearance between the front disc brake pads and front disc. Depress the brake pedal several times until the brake pedal feels firm.
- After replacing the front disc brake pads, always perform a road test to check the braking performance and check for vibrations.
- While the auxiliary battery is connected, even if the ignition switch is off, the brake control system activates when the brake pedal is depressed or any door courtesy switch turns on. Therefore, when servicing the brake system components, do not operate the brake pedal or open/close the doors while the auxiliary battery is connected.
- When the brake pedal is first depressed after replacing the brake pads or pushing back the disc brake piston, DTCs may be stored. As there is no malfunction, clear the DTC.

HINT:

- Use the same procedure for the RH side and LH side.
- The following procedure is for the LH side.

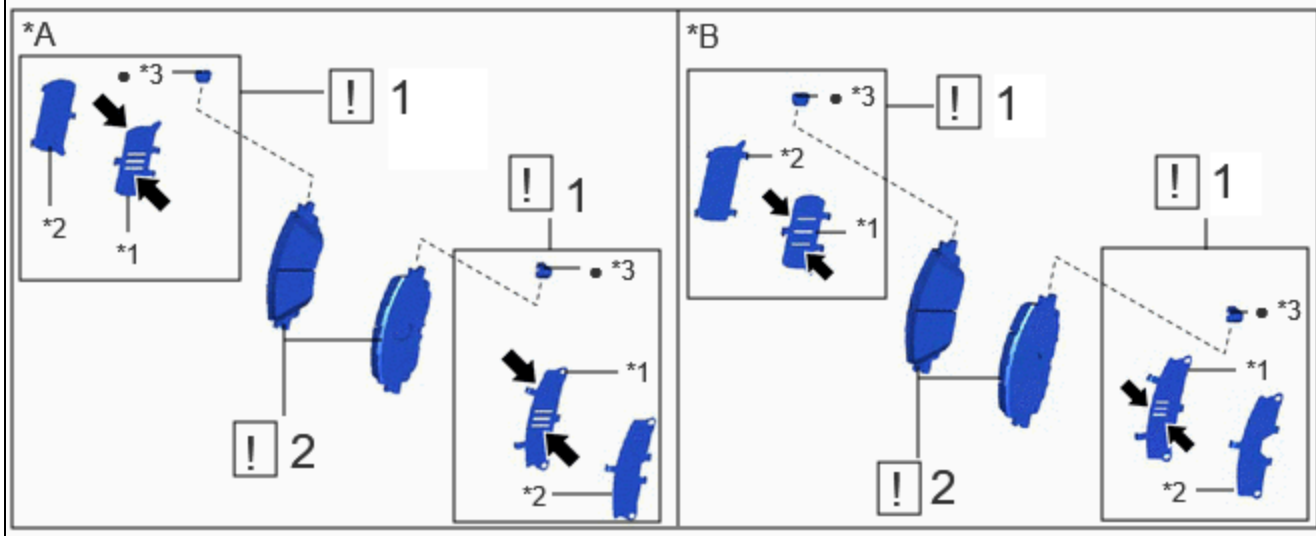
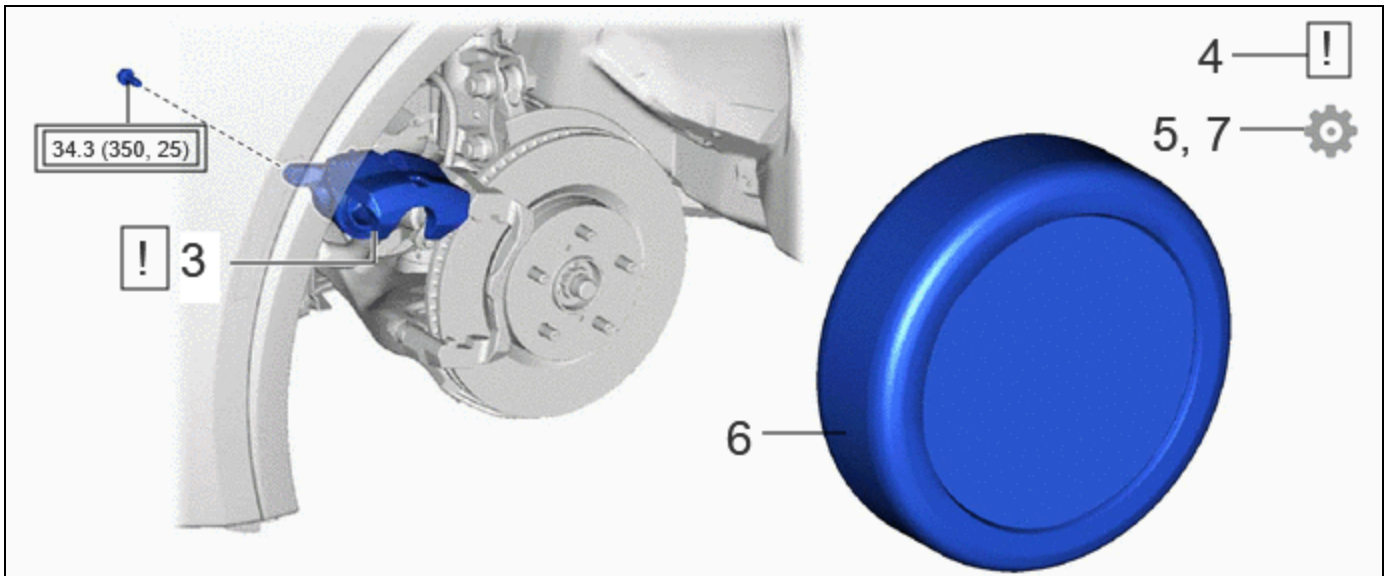

CAUTION / NOTICE / HINT

COMPONENTS (INSTALLATION)



PROCEDURE		PART NAME CODE			
1	FRONT DISC BRAKE ANTI-SQUEAL SHIM KIT	04945	INFO	-	-
2	FRONT DISC BRAKE PAD	-	INFO	-	-
3	FRONT DISC BRAKE CYLINDER ASSEMBLY	-	INFO	-	-
4	CONNECT CABLE TO NEGATIVE AUXILIARY BATTERY TERMINAL	-	INFO	-	-
5	INSPECT BRAKE FLUID LEVEL IN RESERVOIR	-	-	-	INFO
6	FRONT WHEEL	-	-	-	-
7	INITIALIZATION AFTER RECONNECTING AUXILIARY BATTERY TERMINAL	-	-	-	INFO

*A	for HEV Model AWD, PHEV Model	*B	for HEV Model 2WD
----	-------------------------------	----	-------------------

*1	FRONT NO. 1 DISC BRAKE ANTI-SQUEAL SHIM	*2	FRONT NO. 2 DISC BRAKE ANTI-SQUEAL SHIM
*3	FRONT DISC BRAKE PAD WEAR INDICATOR PLATE	-	-
	Tightening torque for "Major areas involving basic vehicle performance such as moving/turning/stopping": N*m (kgf*cm, ft.*lbf)	•	Non-reusable part
	Brake shim grease (Part No. 08887-80409)	-	-

PROCEDURE

1. INSTALL FRONT DISC BRAKE ANTI-SQUEAL SHIM KIT

	<p>NOTICE:</p> <ul style="list-style-type: none"> When replacing worn front disc brake pads, the front disc brake anti-squeal shims and front disc brake pad wear indicator plates must be replaced together with the front disc brake pads. Do not apply lubricants to the lining surface of the brake pad. Install the front disc brake pad wear indicator plates in the correct position and direction. Install the front disc brake anti-squeal shims in the correct position and direction.
---	---

(a) for HEV Model AWD, PHEV Model:

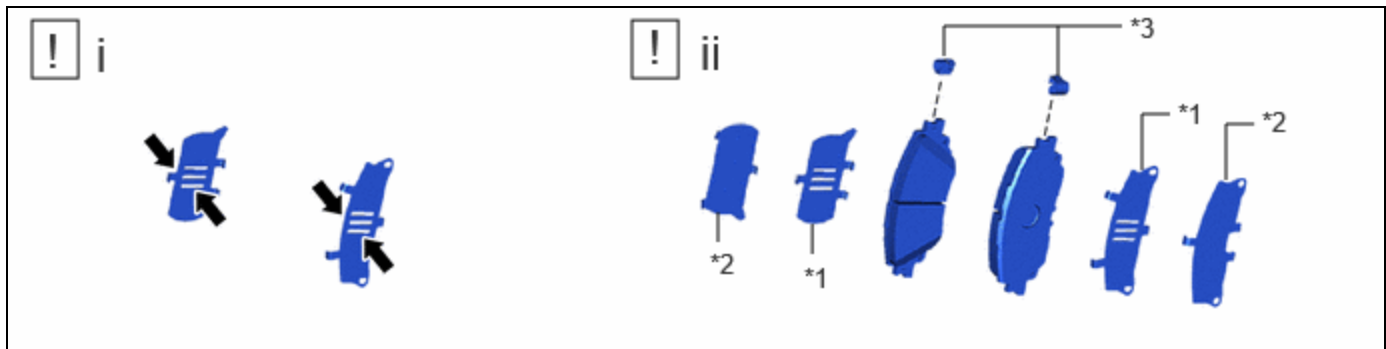

*1	Front No. 1 Disc Brake Anti-squeal Shim	*2	Front No. 2 Disc Brake Anti-squeal Shim
*3	Front Disc Brake Pad Wear Indicator Plate	-	-
	Brake Shim Grease (Part No. 08887-80409)	-	-

- Apply brake shim grease (Part No. 08887-80409) to both sides of each front No. 1 disc brake anti-squeal shim as shown in the illustration.
- Install the front No. 1 disc brake anti-squeal shim and front No. 2 disc brake anti-squeal shim to each front disc brake pad.
- Install a new front disc brake pad wear indicator plate to each front disc brake pad.

(b) for HEV Model 2WD:

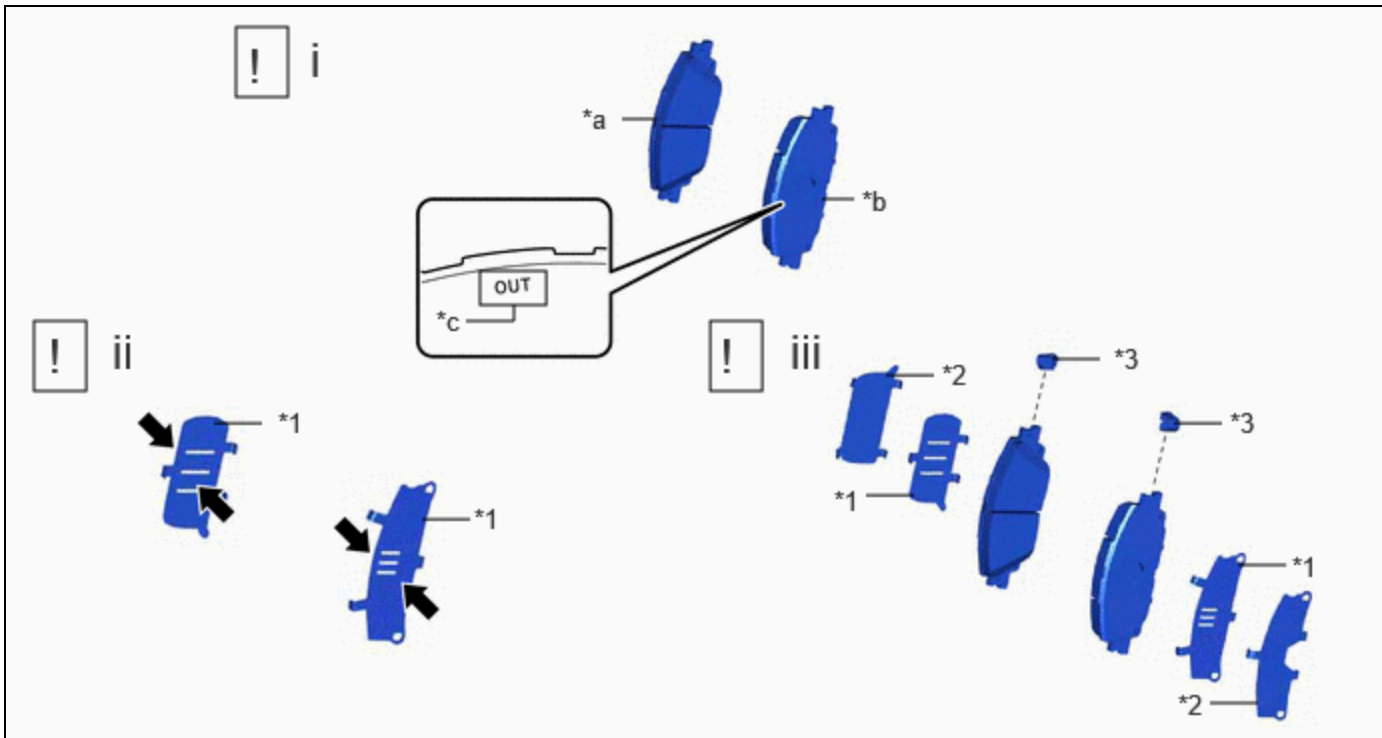

*1	Front No. 1 Disc Brake Anti-squeal Shim	*2	Front No. 2 Disc Brake Anti-squeal Shim
*3	Front Disc Brake Pad Wear Indicator Plate	-	-
*a	Front Disc Brake Pad (Inner Side of the Vehicle)	*b	Front Disc Brake Pad (Outer Side of the Vehicle)
*c	Identification Mark	-	-
	Brake Shim Grease (Part No. 08887-80409)	-	-

(1) Check the front disc brake pad.

HINT:

If the front disc brake pad (outer side) has an identification mark, be sure to confirm the installation location.

- (2) Install the front No. 1 disc brake anti-squeal shim and front No. 2 disc brake anti-squeal shim to each front disc brake pad.
- (3) Install a new front disc brake pad wear indicator plate to each front disc brake pad.

2. INSTALL FRONT DISC BRAKE PAD

CAUTION:

- Be careful not to get pinched by the front disc brake cylinder assembly or other parts when installing the front disc brake pads.
- After lifting up the front disc brake cylinder assembly, secure it in place before performing any work on it.
- The front disc brake cylinder assembly could fall, pinching hands or fingers and causing injury.

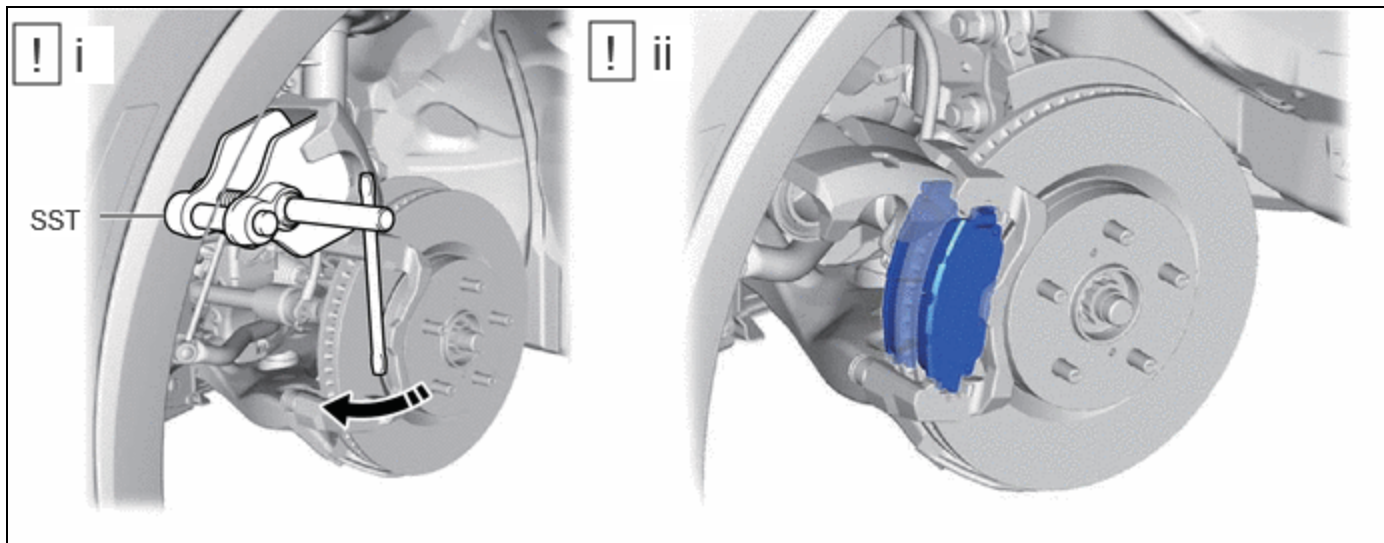
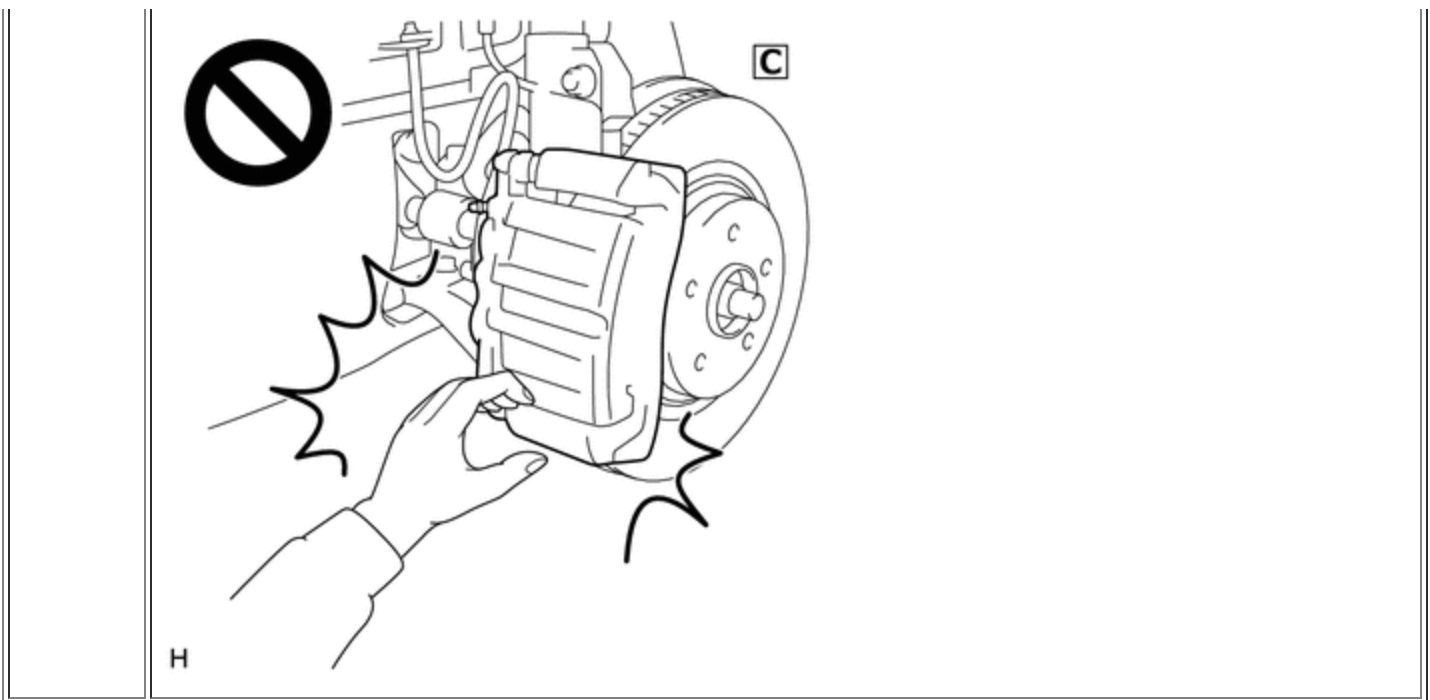

(1) Using SST, push in the front disc brake piston.

SST: 09719-77020

NOTICE:

- Make sure that the brake fluid does not overflow from the reservoir.
- Do not forcibly push in the front disc brake pistons.

(2) Install the 2 front disc brake pads to the front disc brake cylinder mounting.

NOTICE:

- Keep the friction surfaces of the front disc brake pads and front disc free from oil and grease.
- Install the front disc brake pad so that the pad wear indicator plate is mounted on the upper side of the vehicle.

3. INSTALL FRONT DISC BRAKE CYLINDER ASSEMBLY

Torque:

34.3 N·m {350 kgf·cm, 25 ft·lbf}

4. CONNECT CABLE TO NEGATIVE AUXILIARY BATTERY TERMINAL



Click here [INFO](#)

5. INSPECT BRAKE FLUID LEVEL IN RESERVOIR

Click here [INFO](#)

6. INSTALL FRONT WHEEL

Click here [INFO](#)

7. INITIALIZATION AFTER RECONNECTING AUXILIARY BATTERY TERMINAL

HINT:

When disconnecting and reconnecting the auxiliary battery, there is an automatic learning function that completes learning when the respective system is used.

Click here [INFO](#)

