

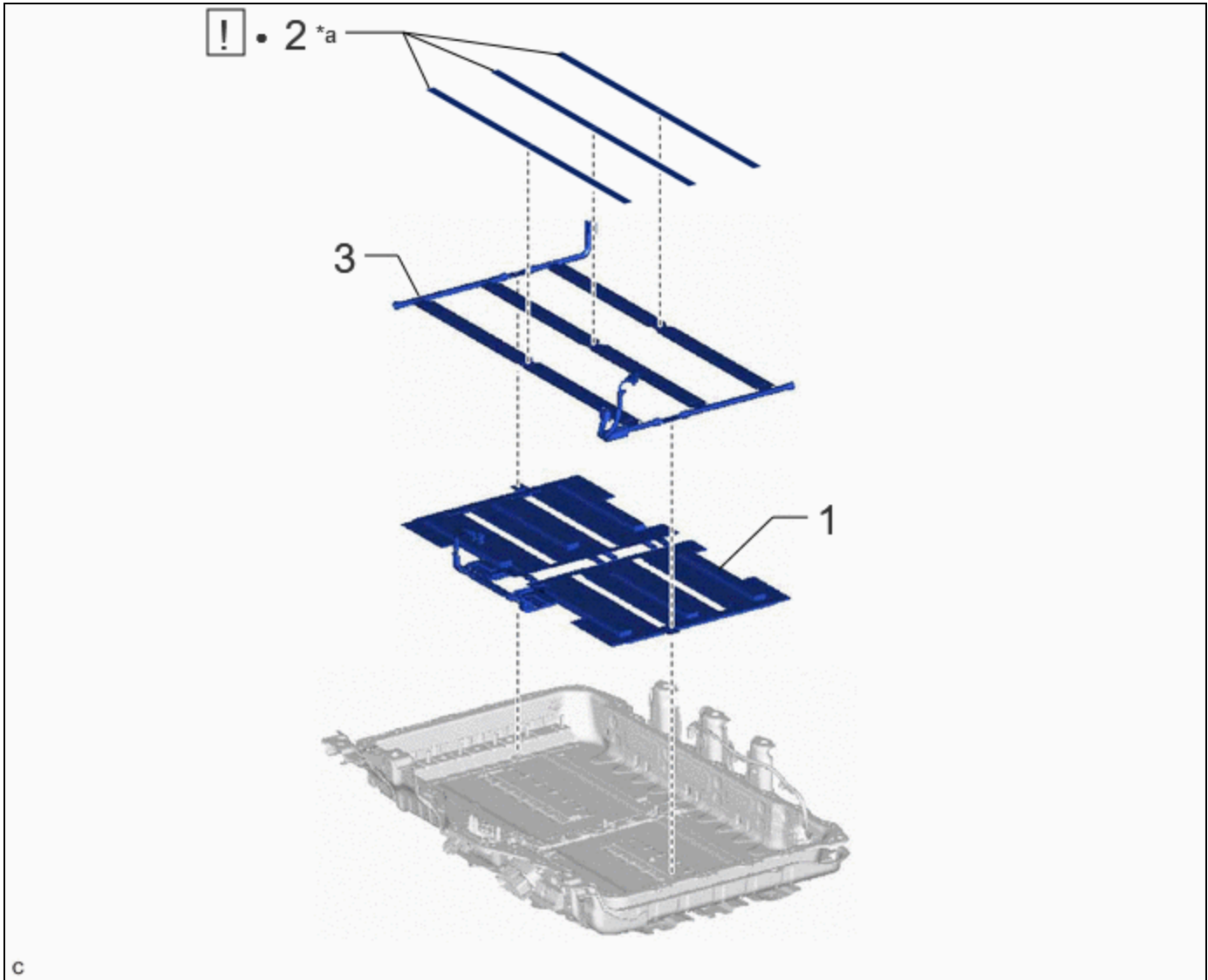



Last Modified: 12-04-2024	6.11:8.1.0	Doc ID: RM10000002B7BM
Model Year Start: 2023	Model: Prius Prime	Prod Date Range: [03/2023 -]
Title: HYBRID / BATTERY CONTROL: HV BATTERY HEATER (for PHEV Model): INSTALLATION; 2023 - 2024 MY Prius Prime [03/2023 -]		



INSTALLATION

CAUTION / NOTICE / HINT

COMPONENTS (INSTALLATION)



PROCEDURE		PART NAME CODE			
1	NO. 1 TRACTION BATTERY HEATER	G96H1	-	-	-
2	NO. 1 TRACTION BATTERY COOLER SHEET	G96NA	INFO	-	-

	PROCEDURE	PART NAME CODE			
3	NO. 1 TRACTION BATTERY COOLER CONDUCTOR	-	INFO	-	-

*a	Parts requiring replacement with new ones when replacing the No. 1 traction battery heater and No. 2 traction battery heater	-	-
•	Non-reusable part	-	-

PROCEDURE

1. INSTALL NO. 1 TRACTION BATTERY HEATER

2. INSTALL NO. 1 TRACTION BATTERY COOLER SHEET

	Click here INFO
---	---------------------------------

3. INSTALL NO. 1 TRACTION BATTERY COOLER CONDUCTOR

Click here [INFO](#)

