

<b>Last Modified:</b> 12-04-2024	6.11:8.1.0	<b>Doc ID:</b> RM1000000029YCG
<b>Model Year Start:</b> 2023	<b>Model:</b> Prius	<b>Prod Date Range:</b> [12/2022 - ]
<b>Title:</b> M20A-FXS (ENGINE MECHANICAL): ENGINE ASSEMBLY (for HEV Model): REMOVAL; 2023 - 2024 MY Prius [12/2022 - ]		

## REMOVAL

### CAUTION / NOTICE / HINT

The necessary procedures (adjustment, calibration, initialization or registration) that must be performed after parts are removed and installed, or replaced during engine assembly removal/installation are shown below.

#### **Necessary Procedures After Parts Removed/Installed/Replaced**

REPLACED PART OR PERFORMED PROCEDURE	NECESSARY PROCEDURE	EFFECT/INOPERATIVE FUNCTION WHEN NECESSARY PROCEDURE NOT PERFORMED	LINK
Replacement of ECM	Perform Vehicle Identification Number (VIN) registration	DTC is output	<a href="#">INFO</a>
	ECU configuration	-	<a href="#">INFO</a>
	Update ECU security key	Vehicle Control History (RoB) are stored	<a href="#">INFO</a>
<ul style="list-style-type: none"> <li>Replacement of engine assembly</li> <li>Gas leak from exhaust system is repaired</li> </ul>	Inspection after repair	<ul style="list-style-type: none"> <li>Poor idle, etc.</li> <li>Engine start function, etc.</li> </ul>	<a href="#">INFO</a>
Replacement of inverter with converter assembly	ECU configuration	-	<a href="#">INFO</a>
	Resolver learning	<ul style="list-style-type: none"> <li>DTCs are stored</li> <li>Slight vibration at a vehicle speed of 5 km/h (3 mph) or less</li> <li>Shock or vibration during acceleration</li> </ul>	<a href="#">INFO</a>

\*: Even when not replacing the part, it is necessary to perform the specified necessary procedures after installation.

\*1: Also necessary after performing a tire rotation.

\*2: It is not necessary to perform this procedure if the tire pressure warning valve and transmitters are installed to the same location.

\*3: The vehicle height changes because of tire replacement.

\*4: If matchmarks were not placed when removing parts related to steering operation, perform end position initial setting.

REPLACED PART OR PERFORMED PROCEDURE	NECESSARY PROCEDURE	EFFECT/INOPERATIVE FUNCTION WHEN NECESSARY PROCEDURE NOT PERFORMED	LINK
Replacement of hybrid vehicle transaxle assembly	<ul style="list-style-type: none"> <li>Resolver learning</li> <li>Initialize resolver</li> </ul>	<ul style="list-style-type: none"> <li>DTCs are stored</li> <li>Slight vibration at a vehicle speed of 5 km/h (3 mph) or less</li> <li>Shock or vibration during acceleration</li> </ul>	<a href="#">INFO</a>
Suspension parts	Rear television camera assembly optical axis (Back camera position setting)	Parking Assist Monitor System	<a href="#">INFO</a>
	Parking assist ECU initialization	Panoramic View Monitor System	<a href="#">INFO</a>
		Advanced Park	<a href="#">INFO</a>
Tires	<ul style="list-style-type: none"> <li>Initialization*1*2</li> <li>Tire Position Identification*1*2</li> </ul>	Tire Pressure Warning System	Refer to Procedures Necessary When Replacing Parts (for Tire Pressure Warning System) table below <a href="#">INFO</a>
	Rear television camera assembly optical axis (Back camera position setting)	Parking Assist Monitor System	<a href="#">INFO</a>
	Parking assist ECU initialization*3	Panoramic View Monitor System	<a href="#">INFO</a>
		Advanced Park	<a href="#">INFO</a>
No. 2 steering intermediate shaft assembly*4	End position initial setting	-	<a href="#">INFO</a>
Replacement of front bumper assembly*	Front television camera view adjustment	Panoramic View Monitor System	<a href="#">INFO</a>
		Advanced Park	<a href="#">INFO</a>

\*: Even when not replacing the part, it is necessary to perform the specified necessary procedures after installation.

\*1: Also necessary after performing a tire rotation.

\*2: It is not necessary to perform this procedure if the tire pressure warning valve and transmitters are installed to the same location.

\*3: The vehicle height changes because of tire replacement.

\*4: If matchmarks were not placed when removing parts related to steering operation, perform end position initial setting.

REPLACED PART OR PERFORMED PROCEDURE	NECESSARY PROCEDURE	EFFECT/INOPERATIVE FUNCTION WHEN NECESSARY PROCEDURE NOT PERFORMED	LINK
Front wheel alignment adjustment	Perform "Calibration"	<ul style="list-style-type: none"> <li>• DTCs are stored</li> <li>• ABS warning light illuminates</li> <li>• Brake system warning light (yellow indicator) illuminates</li> <li>• Slip indicator light illuminates</li> <li>• Electronically controlled brake system disabled or malfunctions</li> </ul>	<a href="#">INFO</a>

\*: Even when not replacing the part, it is necessary to perform the specified necessary procedures after installation.

\*1: Also necessary after performing a tire rotation.

\*2: It is not necessary to perform this procedure if the tire pressure warning valve and transmitters are installed to the same location.

\*3: The vehicle height changes because of tire replacement.

\*4: If matchmarks were not placed when removing parts related to steering operation, perform end position initial setting.

**CAUTION:**

- The engine assembly with transaxle is very heavy. Be sure to follow the procedure described in the repair manual, or the engine lifter may suddenly drop or the engine assembly with transaxle may fall off the engine

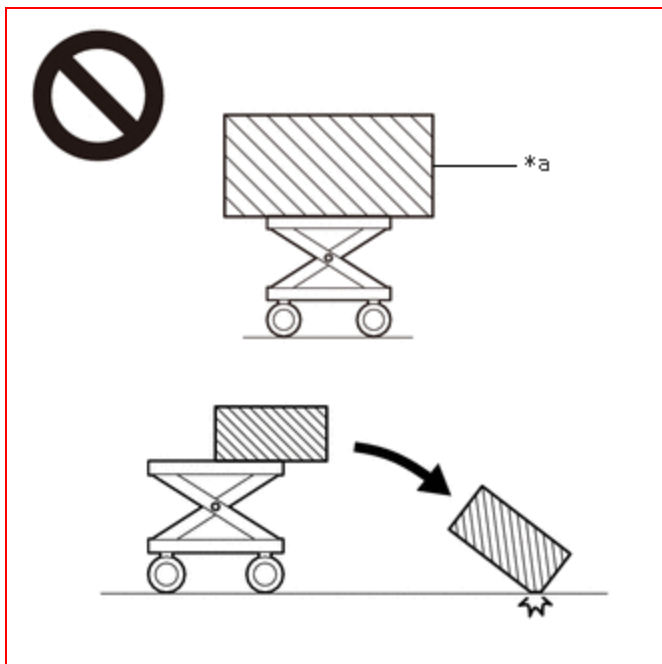

lifter.

*a	An Object Exceeding Weight Limit of Engine Lifter
----	---

- To prevent burns, do not touch the engine, exhaust manifold or other high temperature components while the



engine is hot.

- Orange wire harnesses and connectors indicate high-voltage circuits. To prevent electric shock, always follow



the procedure described in the repair manual.

[Click here](#) INFO

- To prevent electric shock, wear insulated gloves when working on wire harnesses and components of the high



voltage system.

**NOTICE:**

When disconnecting a wire harness of any component connected to the supply power of the integrated capacitor (integration control supply) or when removing the integrated capacitor (integration control supply), make sure to wait 5 minutes or more after turning the ignition switch off for self-diagnosis to complete and the voltage of the integrated capacitor (integration control supply) to discharge.

**HINT:**

When the cable is disconnected / reconnected to the auxiliary battery terminal, systems temporarily stop operating. However, each system has a function that completes learning the first time the system is used.

**Items for which learning is completed by driving the vehicle**

EFFECT/INOPERATIVE FUNCTION WHEN NECESSARY PROCEDURE NOT PERFORMED	NECESSARY PROCEDURES	LINK
Front Camera System	Drive the vehicle straight ahead at 35 km/h (22 mph) or more for 5 seconds or more.	<a href="#">INFO</a>

**Items for which learning is completed by operating the vehicle normally**

EFFECT/INOPERATIVE FUNCTION WHEN NECESSARY PROCEDURE NOT PERFORMED	NECESSARY PROCEDURES	LINK
Power Door Lock Control System*1 <ul style="list-style-type: none"> <li>Back door opener</li> </ul>	Perform door unlock operation with door control switch or electrical key transmitter sub-assembly switch.	<a href="#">INFO</a>
Power Back Door System*2	Reset back door close position	<a href="#">INFO</a>
Air Conditioning System	After the ignition switch is turned to ON, the servo motor standard position is recognized.	-
*1: w/o Power Back Door System		
*2: w/ Power Back Door System		

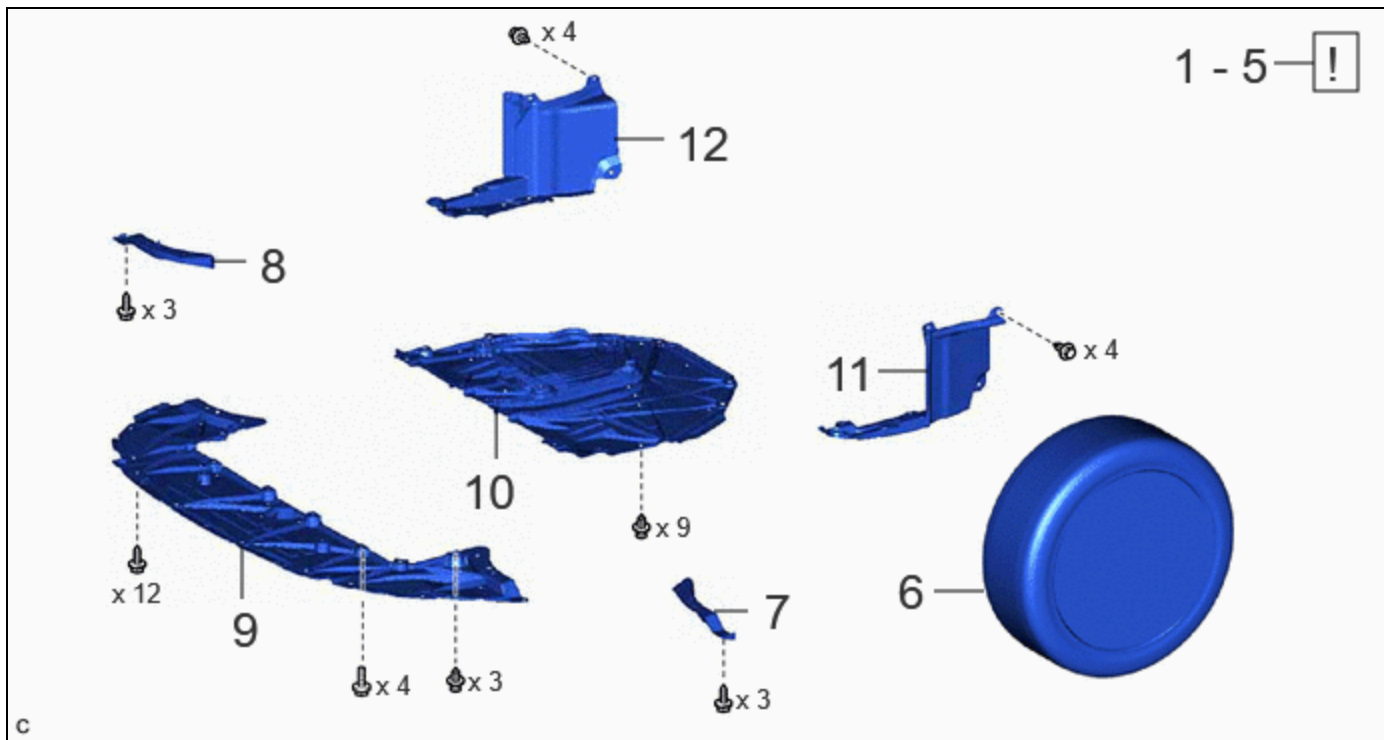

**CAUTION / NOTICE / HINT**

**COMPONENTS (REMOVAL)**



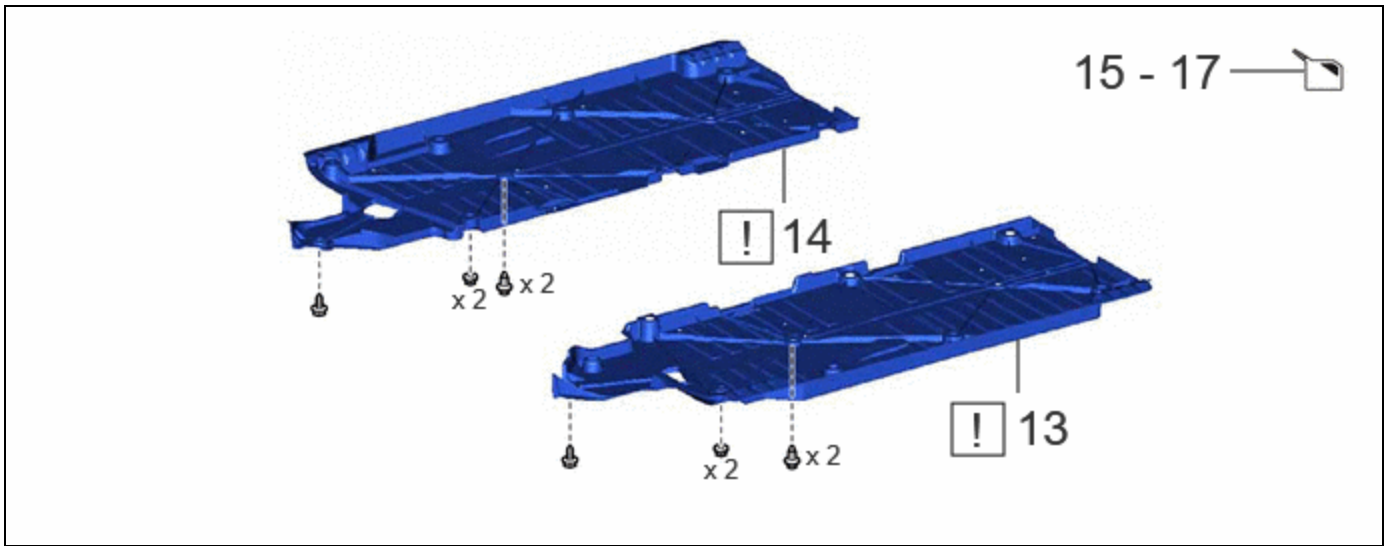

PROCEDURE		PART NAME CODE			
1	PRECAUTION	-	<a href="#">INFO</a>	-	-
2	RECOVER REFRIGERANT FROM REFRIGERATION SYSTEM	-	<a href="#">INFO</a>	-	-
3	DISCHARGE FUEL SYSTEM PRESSURE	-	<a href="#">INFO</a>	-	-
4	ALIGN FRONT WHEELS FACING STRAIGHT AHEAD	-	<a href="#">INFO</a>	-	-
5	SECURE STEERING WHEEL	-	<a href="#">INFO</a>	-	-
6	FRONT WHEELS	-	-	-	-
7	FRONT WHEEL OPENING EXTENSION PAD LH	53852B	-	-	-
8	FRONT WHEEL OPENING EXTENSION PAD RH	53851D	-	-	-
9	CENTER ENGINE UNDER COVER	51451A	-	-	-
10	NO. 1 ENGINE UNDER COVER ASSEMBLY	51410	-	-	-
11	REAR ENGINE UNDER COVER LH	51444A	-	-	-
12	REAR ENGINE UNDER COVER RH	51443C	-	-	-



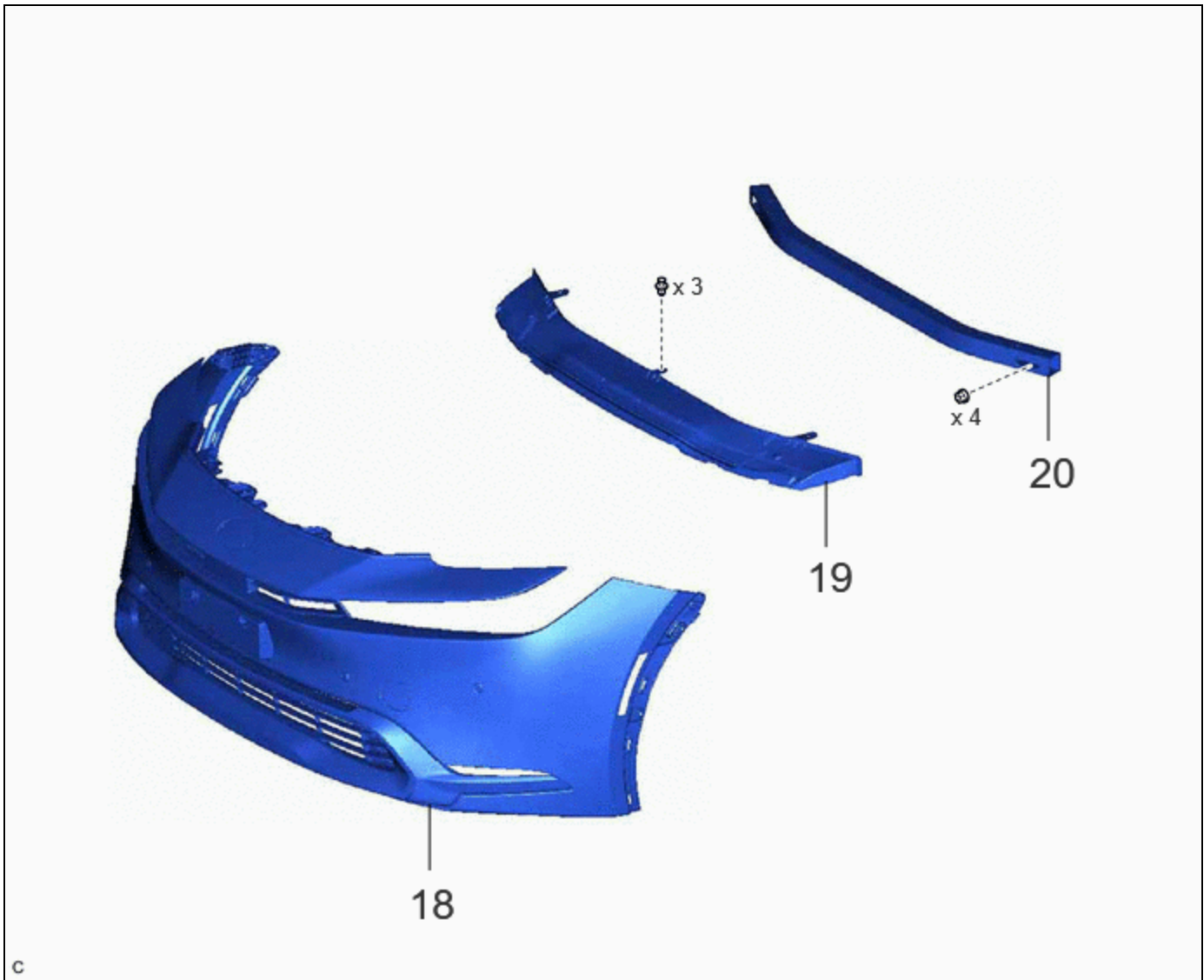

PROCEDURE		PART NAME CODE			
13	FRONT FLOOR COVER LH	58166A	<a href="#">INFO</a>	-	-
14	FRONT FLOOR COVER RH	58165C	<a href="#">INFO</a>	-	-
15	DRAIN ENGINE OIL	-	-	<a href="#">INFO</a>	-
16	DRAIN ENGINE COOLANT (for Engine)	-	-	<a href="#">INFO</a>	-
17	DRAIN HYBRID TRANSAXLE FLUID	-	-	<a href="#">INFO</a>	-



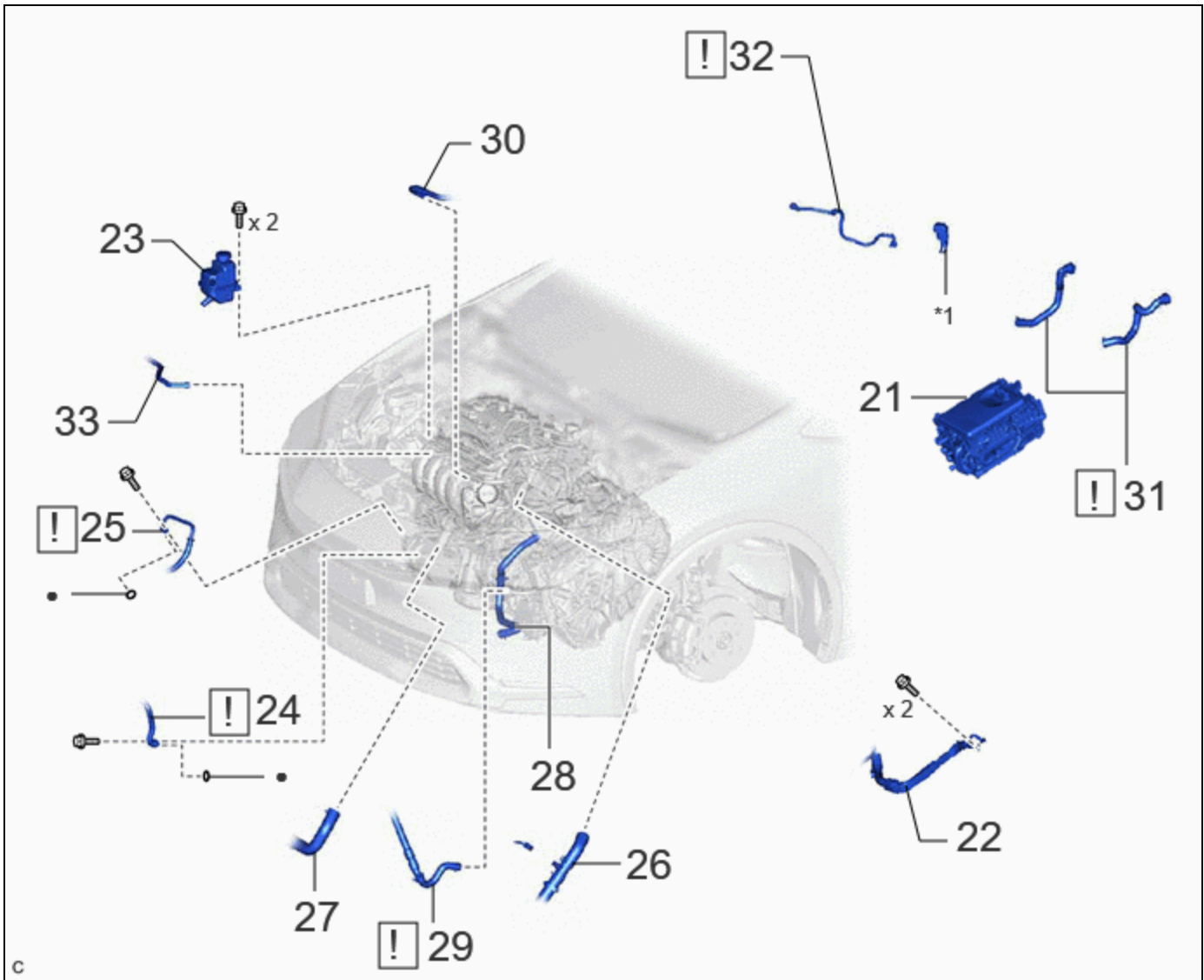

PROCEDURE		PART NAME CODE			
18	FRONT BUMPER ASSEMBLY	-	-	-	-
19	FRONT BUMPER LOWER ABSORBER	52618	-	-	-
20	NO. 2 FRONT BUMPER REINFORCEMENT	52132A	-	-	-







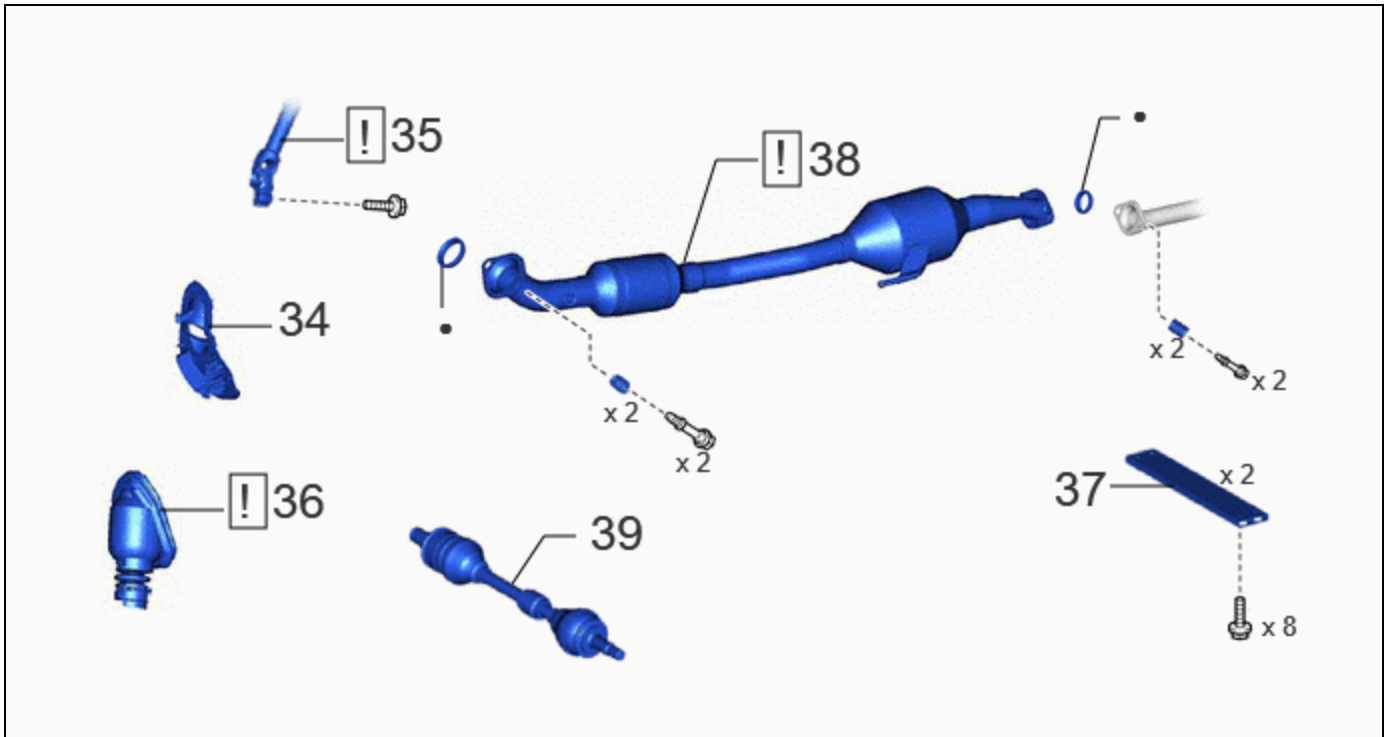

PROCEDURE		PART NAME CODE	!		
21	INVERTER WITH CONVERTER ASSEMBLY	G9200	-	-	-
22	NO. 7 ENGINE WIRE	82127D	-	-	-
23	INVERTER RESERVE TANK ASSEMBLY	G910GB	-	-	-
24	SUCTION HOSE SUB-ASSEMBLY	88704	INFO	-	-
25	DISCHARGE HOSE SUB-ASSEMBLY	88703	INFO	-	-
26	NO. 1 RADIATOR HOSE	16571C	-	-	-
27	NO. 2 RADIATOR HOSE	16572D	-	-	-
28	INLET NO. 1 INVERTER COOLING HOSE	G922AA	-	-	-
29	OUTLET NO. 2 INVERTER COOLING HOSE	G922D	INFO	-	-
30	NO. 1 FUEL VAPOR FEED HOSE	23826	-	-	-
31	WATER HOSE SUB-ASSEMBLY	87209J	INFO	-	-

PROCEDURE		PART NAME CODE			
32	FUEL TUBE SUB-ASSEMBLY	23901	INFO	-	-
33	NO. 4 WATER BY-PASS HOSE	16281	-	-	-

*1	EFI FUEL PIPE CLAMP	-	-
•	Non-reusable part	-	-



PROCEDURE		PART NAME CODE			
34	COLUMN HOLE COVER SILENCER SHEET	45259A	-	-	-
35	NO. 2 STEERING INTERMEDIATE SHAFT ASSEMBLY	45260	INFO	-	-
36	NO. 1 STEERING COLUMN HOLE COVER SUB-ASSEMBLY	45025D	INFO	-	-
37	FRONT FLOOR CENTER BRACE	57533B	-	-	-
38	FRONT EXHAUST PIPE ASSEMBLY	17410	INFO	-	-
39	DRIVE SHAFT ASSEMBLY	-	-	-	-

•	Non-reusable part	-	-
---	-------------------	---	---

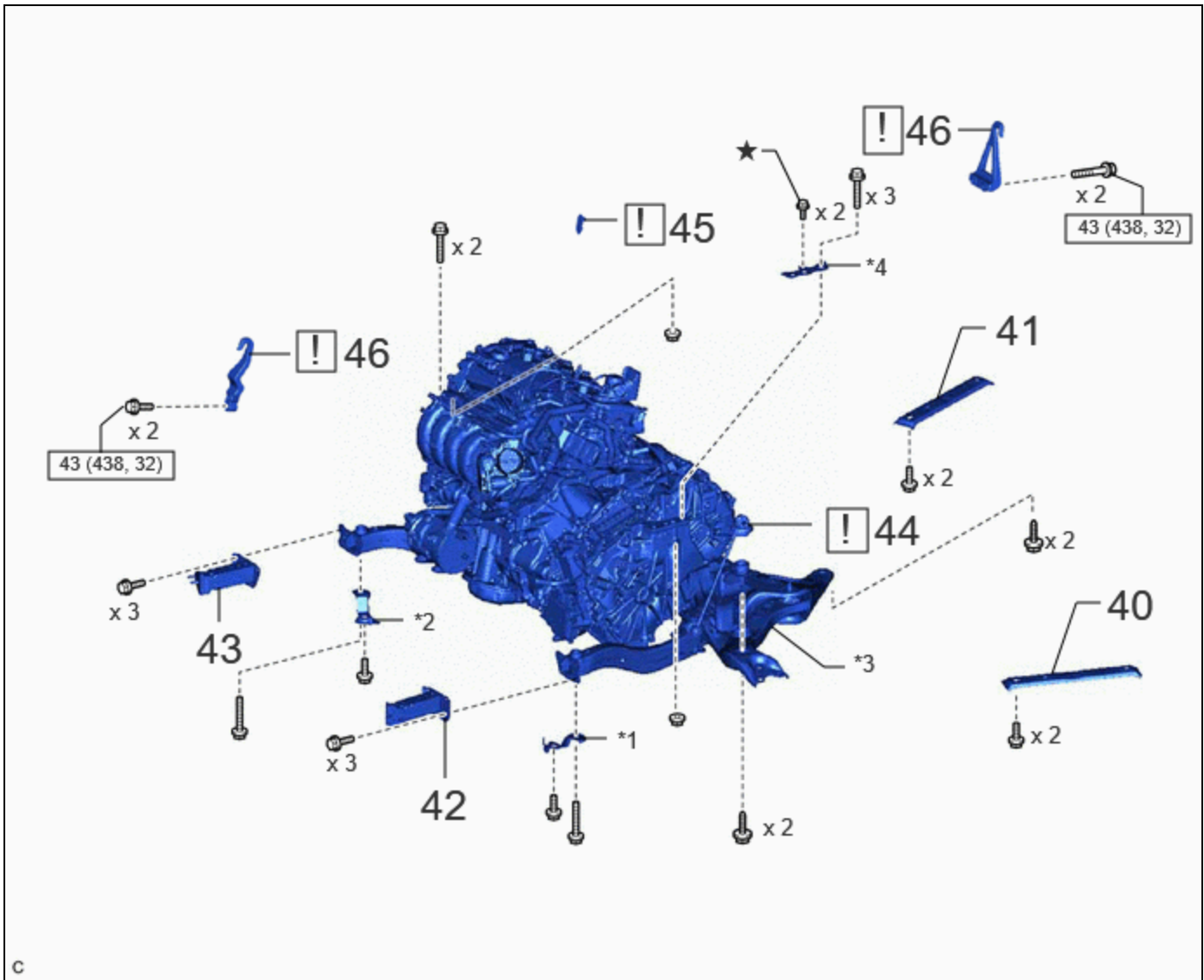



PROCEDURE		PART NAME CODE			
40	NO. 2 CROSSMEMBER GUSSET LH	51322	-	-	-
41	NO. 2 CROSSMEMBER GUSSET RH	51321	-	-	-
42	FRONT BUMPER EXTENSION SUB-ASSEMBLY LH	52103A	-	-	-
43	FRONT BUMPER EXTENSION SUB-ASSEMBLY RH	52102B	-	-	-
44	ENGINE ASSEMBLY WITH TRANSAXLE	-	INFO	-	-
45	ENGINE MOUNTING BRACKET CAP	12353	INFO	-	-
46	INSTALL ENGINE HANGERS	-	INFO	-	-

*1	CENTER RADIATOR SUPPORT LH	*2	CENTER RADIATOR SUPPORT RH
*3	FRONT SUSPENSION CROSSMEMBER SUB-ASSEMBLY	*4	NO. 2 ENGINE MOUNTING STAY LH

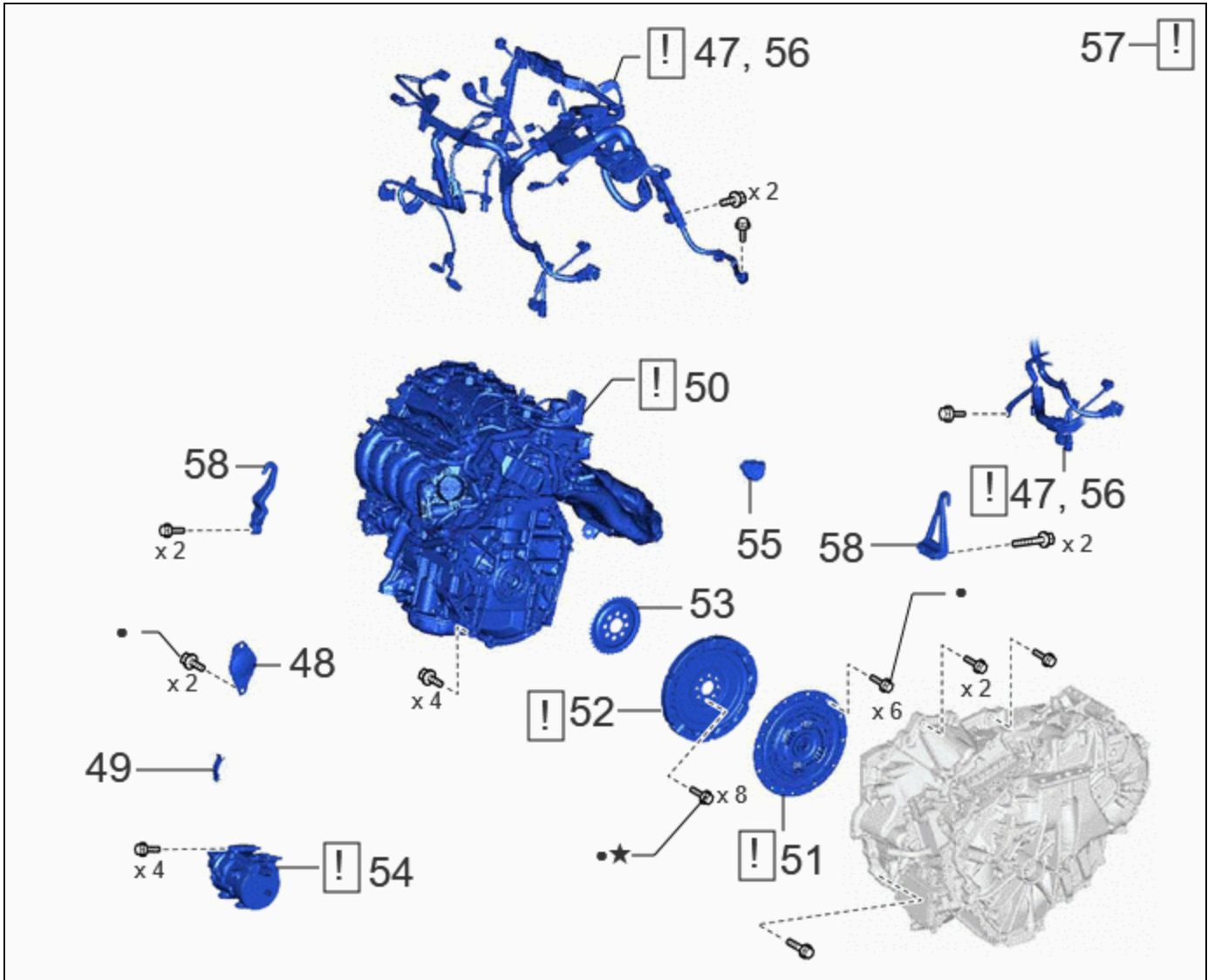
□	N*m (kgf*cm, ft.*lbf): Specified torque	★	Precoated part
---	---	---	----------------





PROCEDURE		PART NAME CODE	!	📄	⚙️
47	DISCONNECT ENGINE WIRE	82121	INFO	-	-
48	STARTER HOLE INSULATOR	28193	-	-	-
49	FLYWHEEL HOUSING SIDE COVER	11363A	-	-	-
50	ENGINE ASSEMBLY	-	INFO	-	-
51	TRANSMISSION INPUT DAMPER ASSEMBLY	31270	INFO	-	-
52	FLYWHEEL SUB-ASSEMBLY	13405	INFO	-	-
53	NO. 1 CRANKSHAFT POSITION SENSOR PLATE	19315	-	-	-

	PROCEDURE	PART NAME CODE			
54	COMPRESSOR WITH MOTOR ASSEMBLY	88370	INFO	-	-
55	FLYWHEEL HOUSING UNDER COVER	11361J	-	-	-
56	REMOVE ENGINE WIRE	82121	-	-	-
57	INSTALL ENGINE ASSEMBLY TO ENGINE STAND	-	INFO	-	-
58	REMOVE ENGINE HANGERS	-	-	-	-

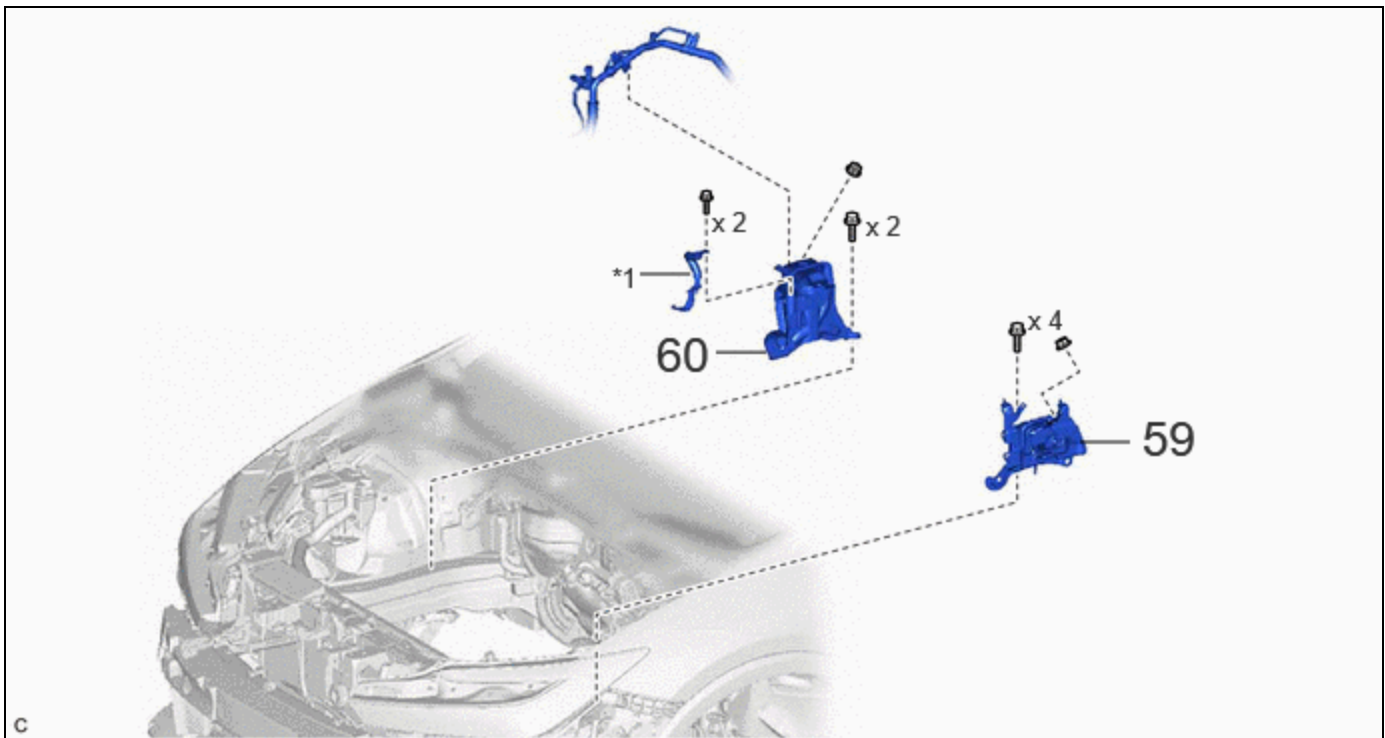
•	Non-reusable part	★	Precoated part
---	-------------------	---	----------------



	PROCEDURE	PART NAME CODE			
59	ENGINE MOUNTING INSULATOR LH	12372A	-	-	-
60	ENGINE MOUNTING INSULATOR SUB-ASSEMBLY RH	12305	-	-	-

*1	NO. 2 EARTH WIRE	-	-
----	------------------	---	---

## PROCEDURE

### 1. PRECAUTION

**NOTICE:**

- After the ignition switch is turned off, there may be a waiting time before disconnecting the negative (-) auxiliary battery terminal.  
Click here [INFO](#)
- When replacing the auxiliary battery, use a new auxiliary battery of the same dimensions and same capacity or more from the same class at a 20-hour rate.
- After replacing the auxiliary battery, install the ventilation hole plug supplied with the new auxiliary battery or the ventilation hole plug from the old auxiliary battery to the ventilation hole on the side to which the battery hose is not connected.

**2. RECOVER REFRIGERANT FROM REFRIGERATION SYSTEM**

- for HFC-134a (R134a):

Click here [INFO](#)

- for HFO-1234yf (R1234yf):

Click here [INFO](#)

**3. DISCHARGE FUEL SYSTEM PRESSURE**

Click here [INFO](#)

**4. ALIGN FRONT WHEELS FACING STRAIGHT AHEAD**

Click here [INFO](#)

**5. SECURE STEERING WHEEL**

Click here [INFO](#)

**6. REMOVE FRONT WHEELS**

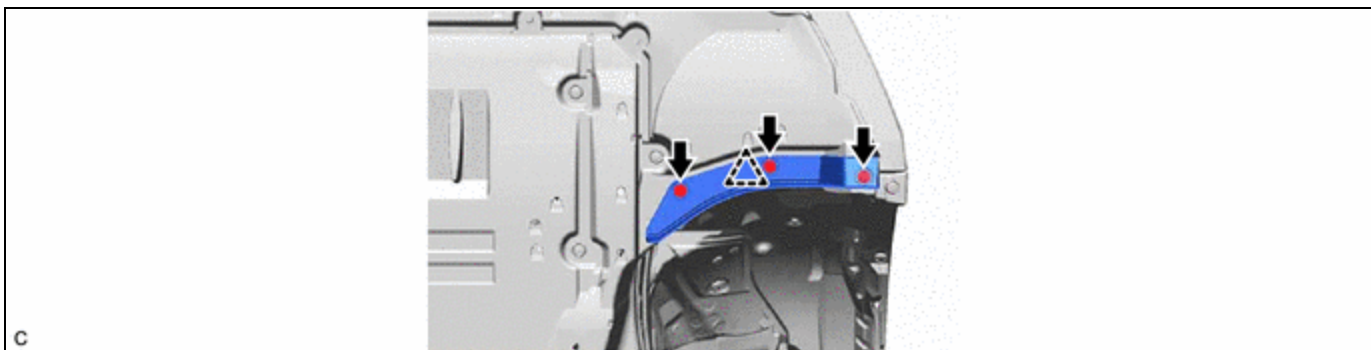

Click here [INFO](#)

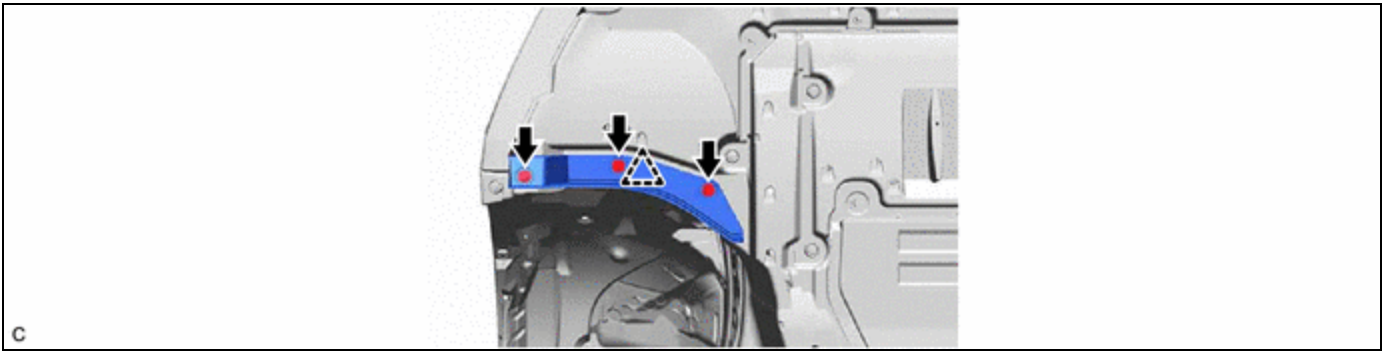
**7. REMOVE FRONT WHEEL OPENING EXTENSION PAD LH****8. REMOVE FRONT WHEEL OPENING EXTENSION PAD RH**

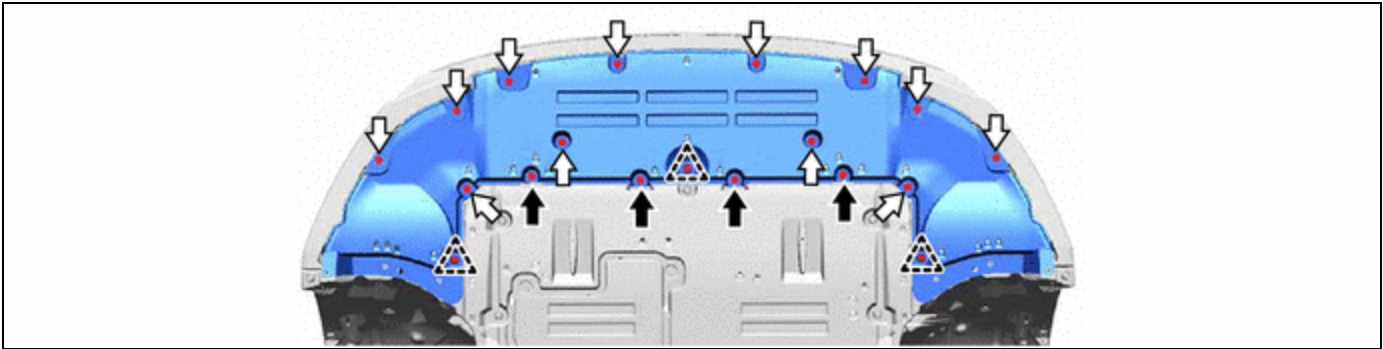

**9. REMOVE CENTER ENGINE UNDER COVER**



	Bolt		Screw
---	------	---	-------

**10. REMOVE NO. 1 ENGINE UNDER COVER ASSEMBLY**

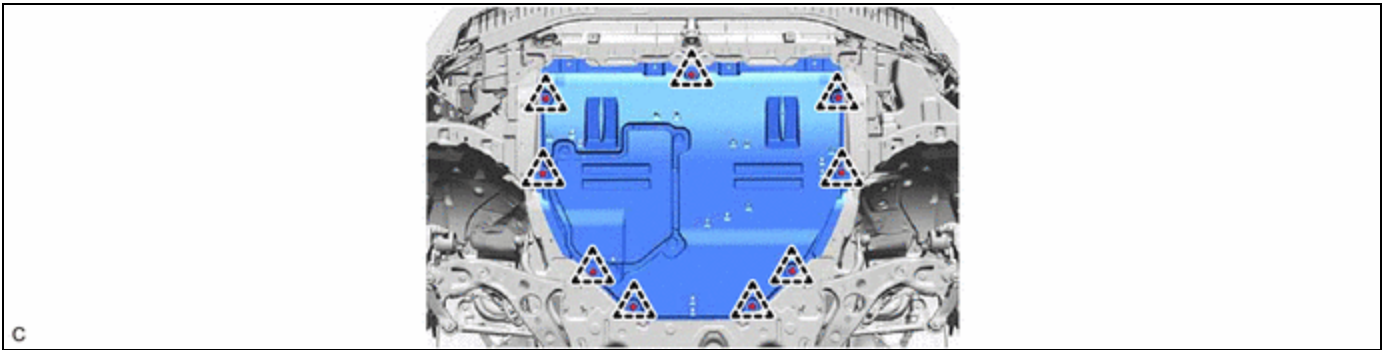

**11. REMOVE REAR ENGINE UNDER COVER LH**

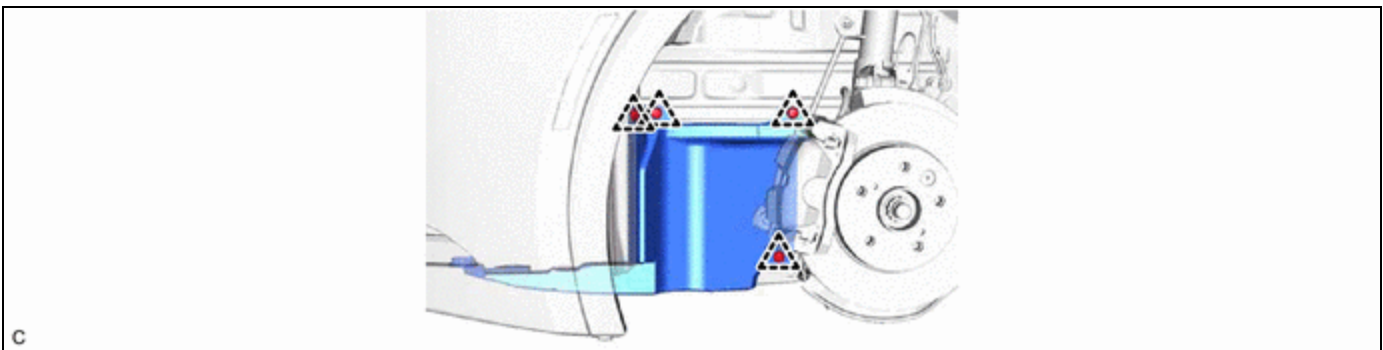

**12. REMOVE REAR ENGINE UNDER COVER RH**

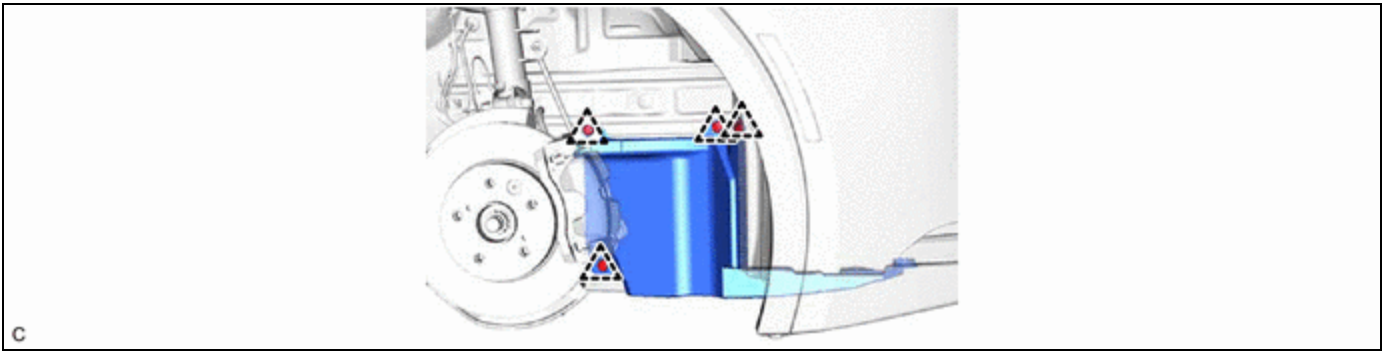

### 13. REMOVE FRONT FLOOR COVER LH



Click here [INFO](#)

### 14. REMOVE FRONT FLOOR COVER RH



Click here [INFO](#)

### 15. DRAIN ENGINE OIL

Click here [INFO](#)

### 16. DRAIN ENGINE COOLANT (for Engine)

Click here [INFO](#)

### 17. DRAIN HYBRID TRANSAXLE FLUID

Click here [INFO](#)

### 18. REMOVE FRONT BUMPER ASSEMBLY

Click here [INFO](#)

### 19. REMOVE FRONT BUMPER LOWER ABSORBER

Click here [INFO](#)

### 20. REMOVE NO. 2 FRONT BUMPER REINFORCEMENT

Click here [INFO](#)

### 21. REMOVE INVERTER WITH CONVERTER ASSEMBLY

Click here [INFO](#)

### 22. DISCONNECT NO. 7 ENGINE WIRE



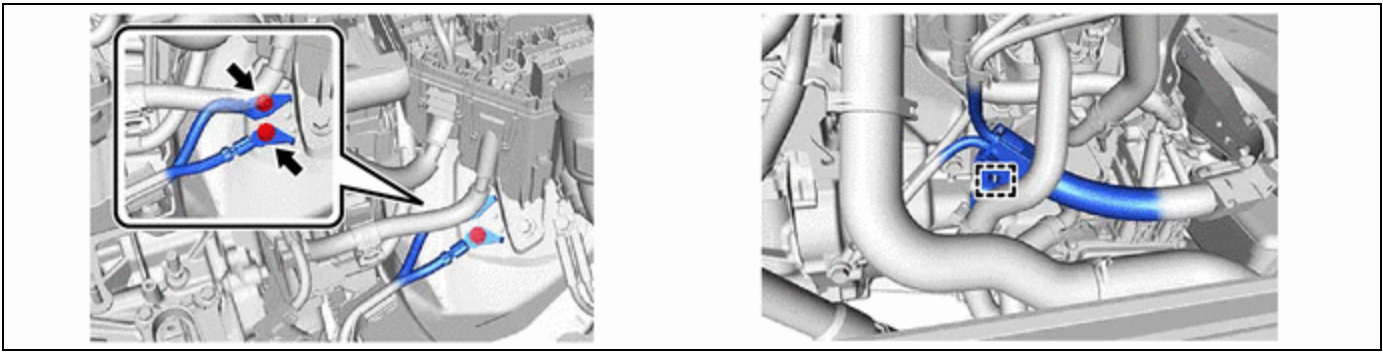

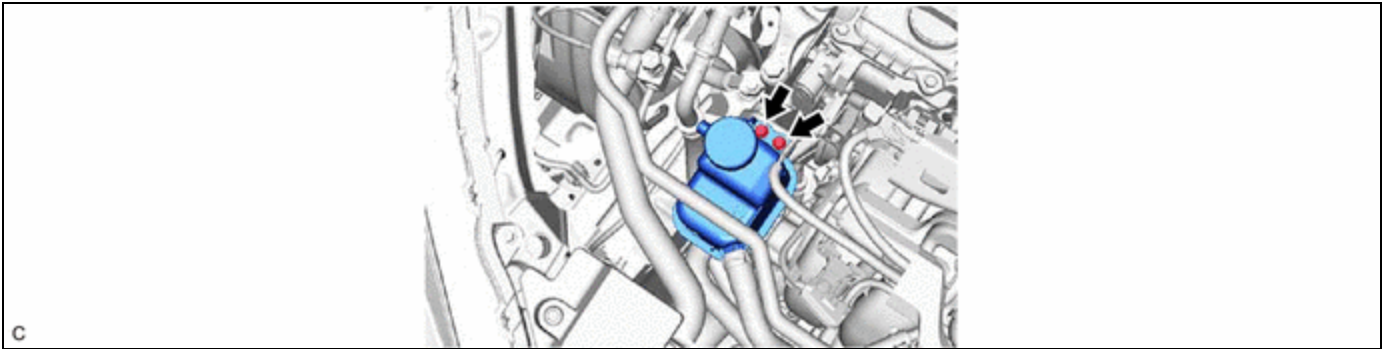

**23. DISCONNECT INVERTER RESERVE TANK ASSEMBLY**



**24. DISCONNECT SUCTION HOSE SUB-ASSEMBLY**

	Click here <a href="#">INFO</a>
---	---------------------------------

**25. DISCONNECT DISCHARGE HOSE SUB-ASSEMBLY**

	Click here <a href="#">INFO</a>
---	---------------------------------

**26. DISCONNECT NO. 1 RADIATOR HOSE**

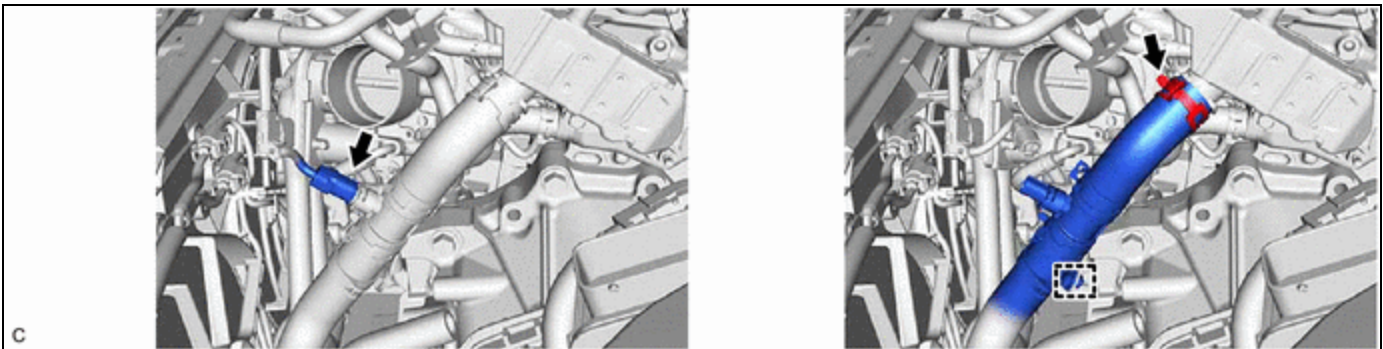

**27. DISCONNECT NO. 2 RADIATOR HOSE**

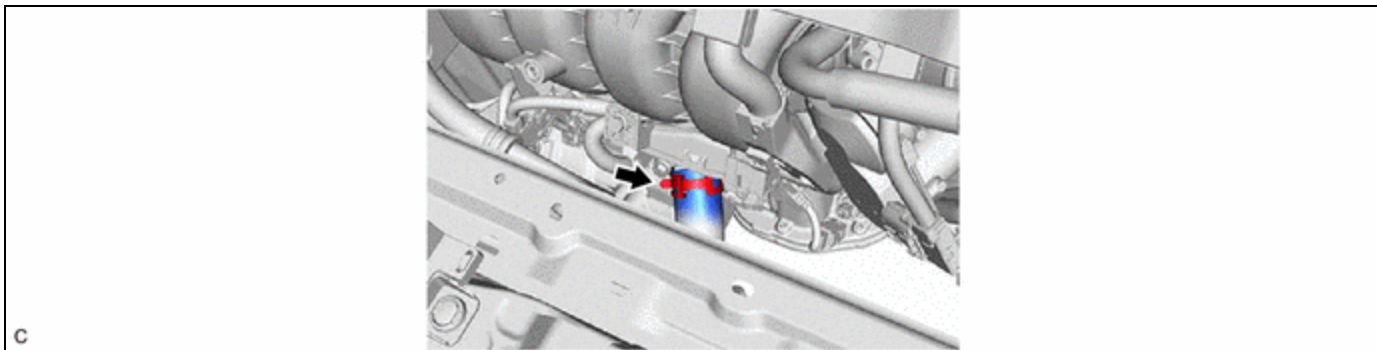

**28. DISCONNECT INLET NO. 1 INVERTER COOLING HOSE**

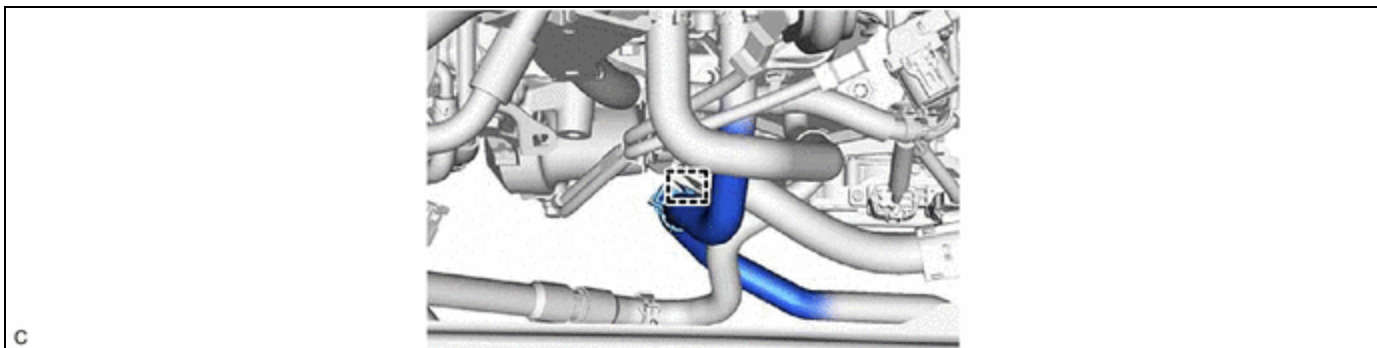

**29. DISCONNECT OUTLET NO. 2 INVERTER COOLING HOSE**

	Click here <a href="#">INFO</a>
---	---------------------------------

**30. REMOVE NO. 1 FUEL VAPOR FEED HOSE**

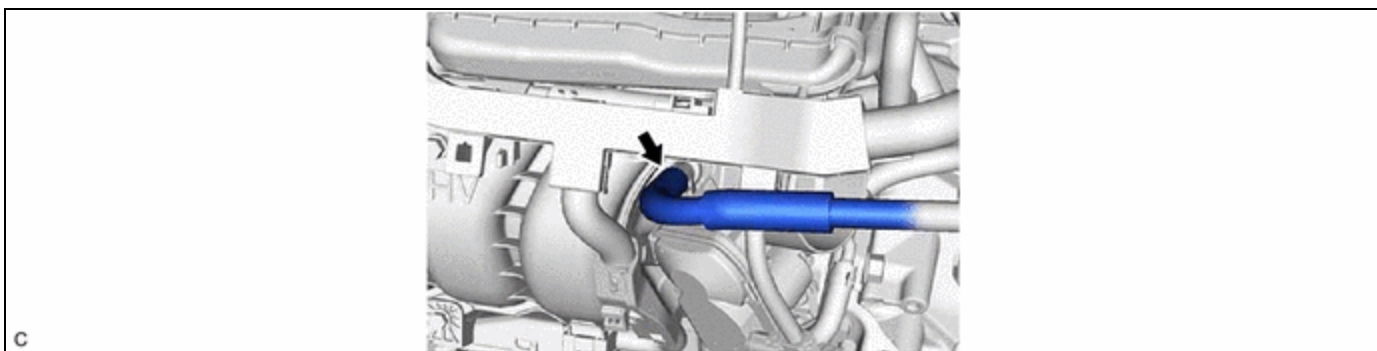

**31. DISCONNECT WATER HOSE SUB-ASSEMBLY**

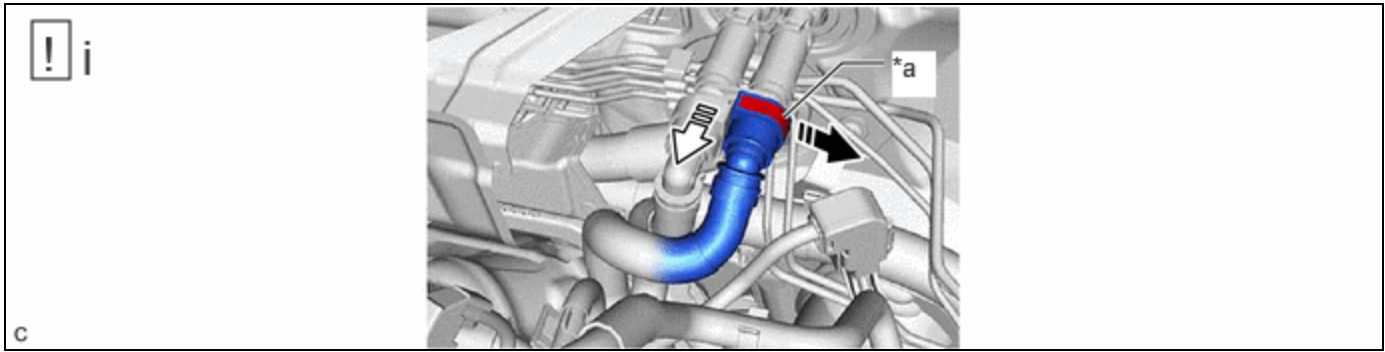

*a	Retainer	-	-
	Pull out		Pull off

(1) Disconnect the water hose sub-assembly connector.

**NOTICE:**

Remove any foreign matter on the water hose sub-assembly connector before performing this work.

1. Pull out the retainer to disengage the lock claws and pull off the water hose sub-assembly connector.
2. Check that there is no foreign matter on the sealing surfaces of the disconnected water lines. Clean them if necessary.
3. Cover the disconnected water hose and water hose sub-assembly connector with a plastic bag to prevent damage and contamination.

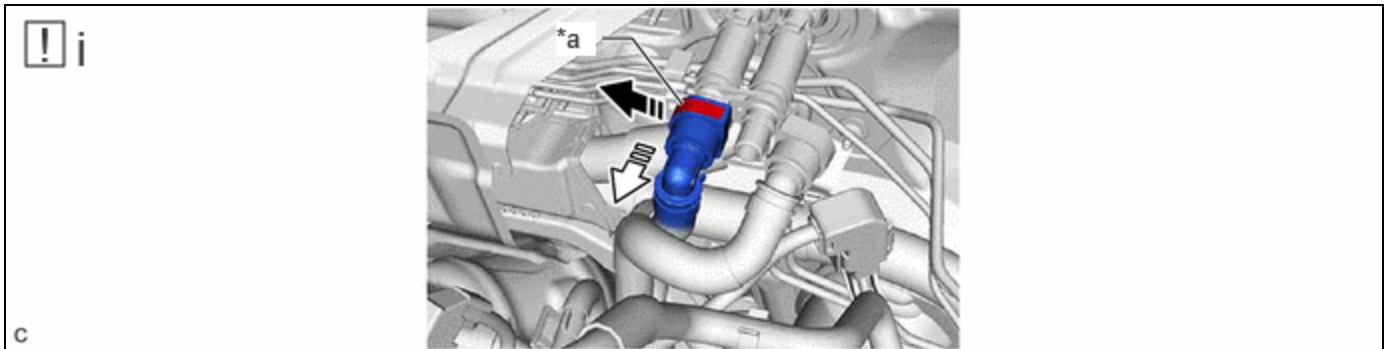

*a	Retainer	-	-
	Pull out		Pull off

(1) Disconnect the water hose sub-assembly connector.

**NOTICE:**

Remove any foreign matter on the water hose sub-assembly connector before performing this work.

1. Pull out the retainer to disengage the lock claws and pull off the water hose sub-assembly connector.
2. Check that there is no foreign matter on the sealing surfaces of the disconnected water lines. Clean them if necessary.
3. Cover the disconnected water hose and water hose sub-assembly connector with plastic bags to prevent damage and contamination.

### 32. DISCONNECT FUEL TUBE SUB-ASSEMBLY

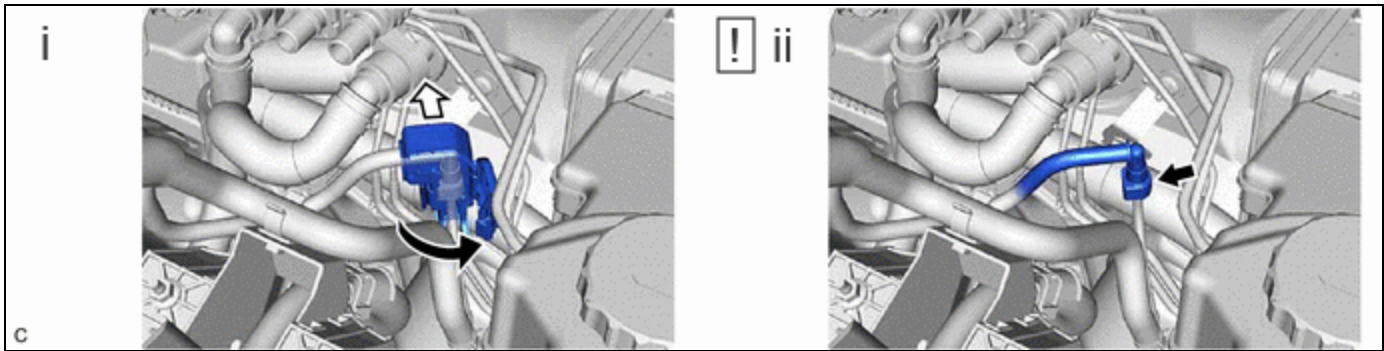

- (1) Disengage the claw and remove the EFI fuel pipe clamp as shown in the illustration.
- (2) Disconnect the fuel tube sub-assembly from the fuel pipe.

Click here [INFO](#)

### 33. DISCONNECT NO. 4 WATER BY-PASS HOSE

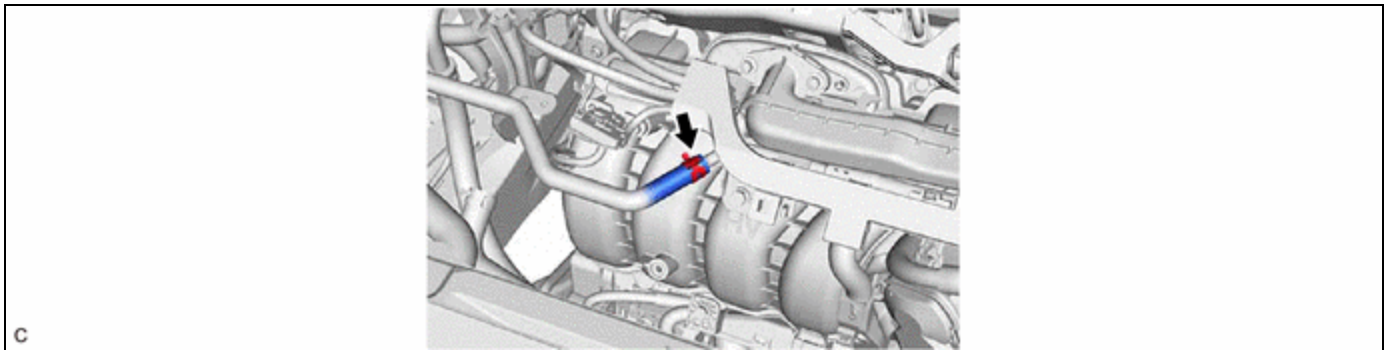

### 34. REMOVE COLUMN HOLE COVER SILENCER SHEET

Click here [INFO](#)

### 35. SEPARATE NO. 2 STEERING INTERMEDIATE SHAFT ASSEMBLY

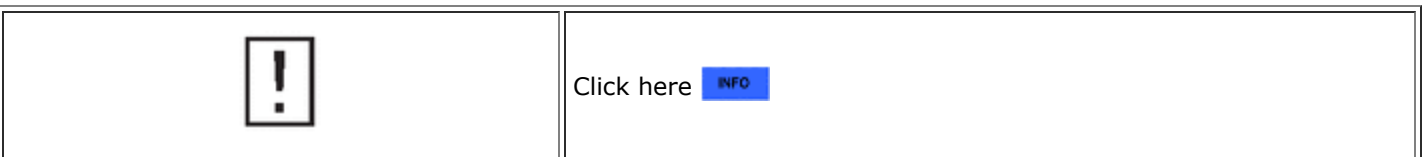

### 36. SEPARATE NO. 1 STEERING COLUMN HOLE COVER SUB-ASSEMBLY

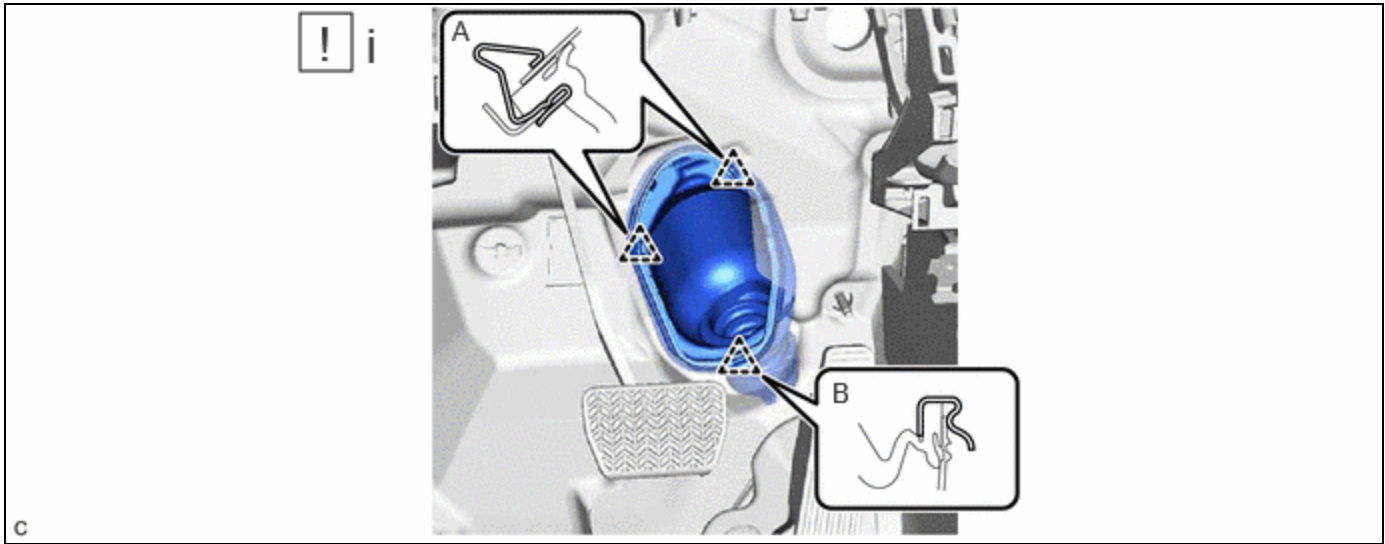

(1) Separate the 2 clips (A), disengage the clip (B) from the vehicle body and separate the No. 1 steering column hole cover sub-assembly.

**NOTICE:**

Do not damage the clips (A) or (B).

**37. REMOVE FRONT FLOOR CENTER BRACE**

Click here [INFO](#)

**38. REMOVE FRONT EXHAUST PIPE ASSEMBLY**

	Click here <a href="#">INFO</a>
--	---------------------------------

**39. REMOVE DRIVE SHAFT ASSEMBLY**

Click here [INFO](#)

**40. REMOVE NO. 2 CROSSMEMBER GUSSET LH**

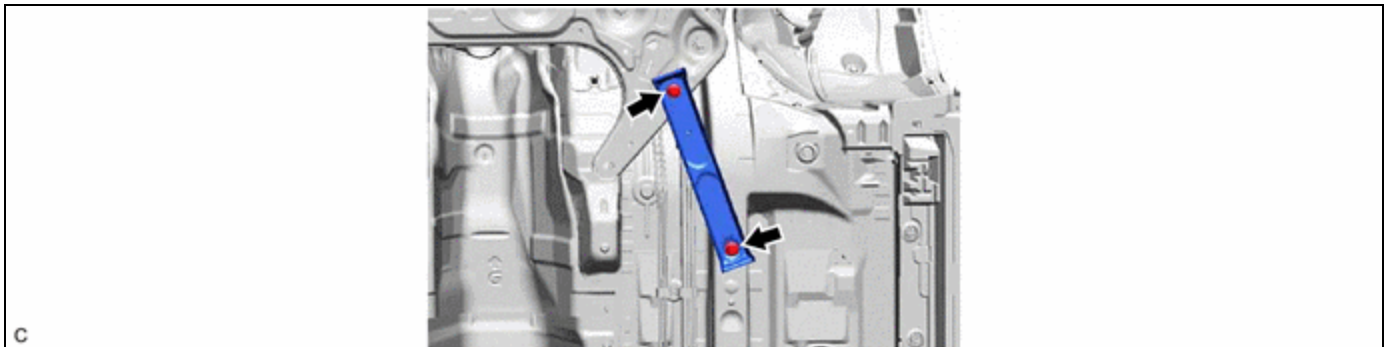

**41. REMOVE NO. 2 CROSSMEMBER GUSSET RH**

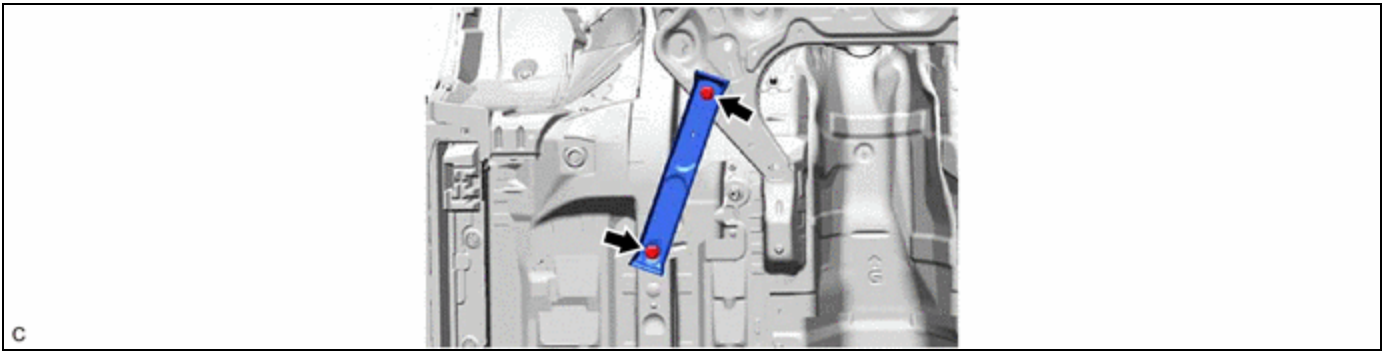

**42. REMOVE FRONT BUMPER EXTENSION SUB-ASSEMBLY LH**

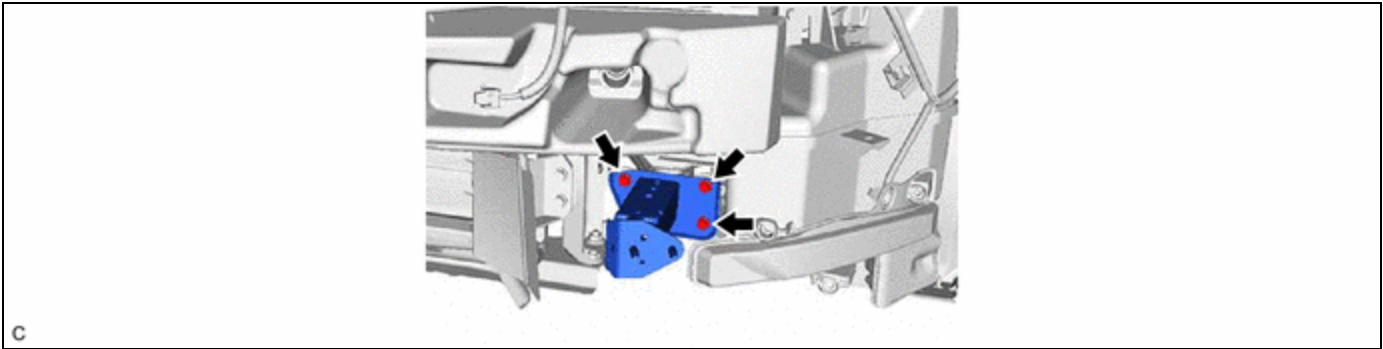

**43. REMOVE FRONT BUMPER EXTENSION SUB-ASSEMBLY RH**

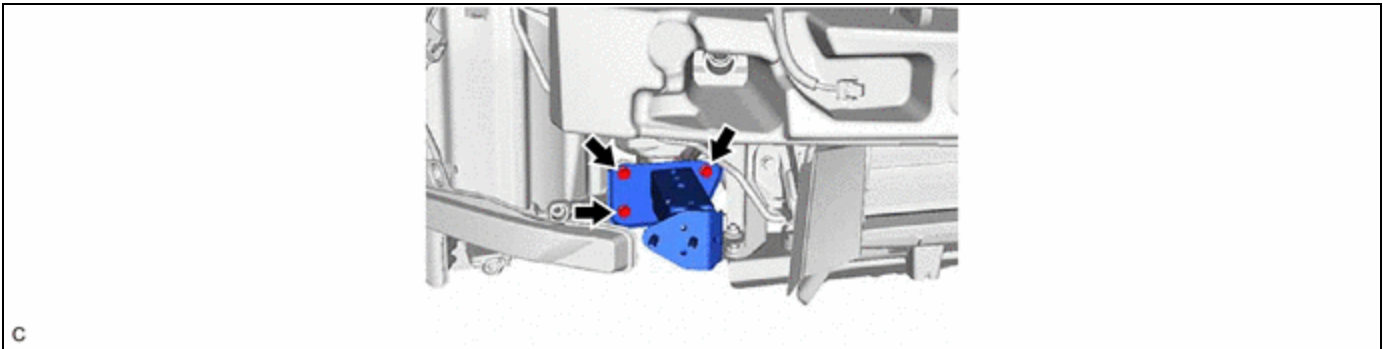

**44. REMOVE ENGINE ASSEMBLY WITH TRANSAXLE**

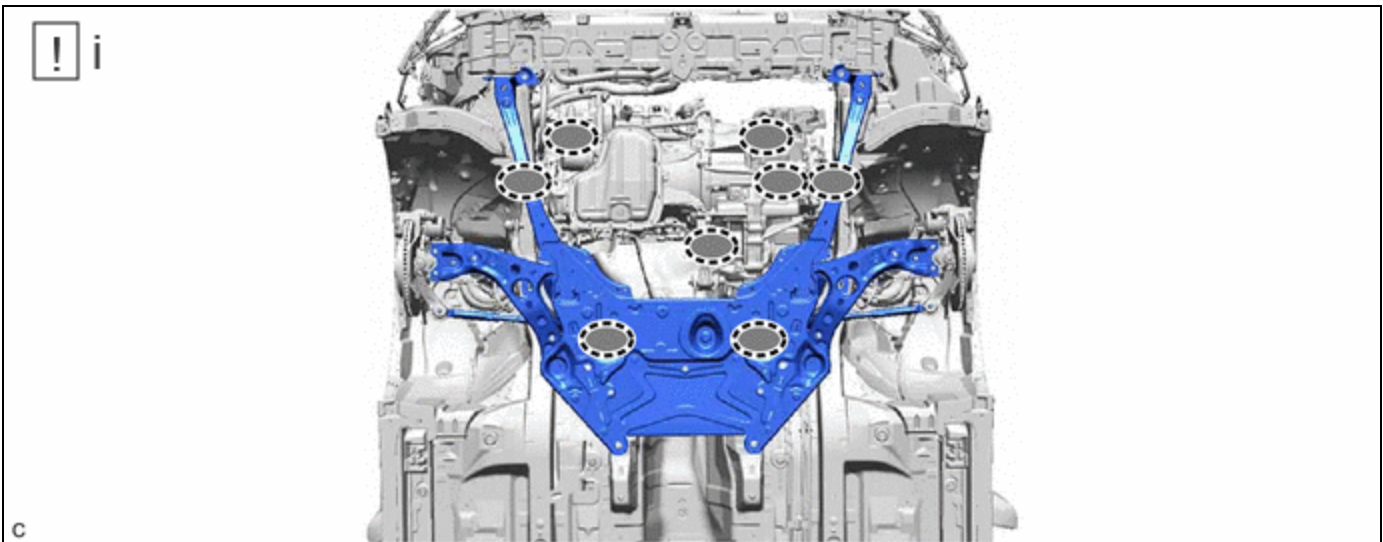



	Attachment Installation Position	-	-
---	----------------------------------	---	---

(1) Set the engine assembly with transaxle on an engine lifter.

**NOTICE:**

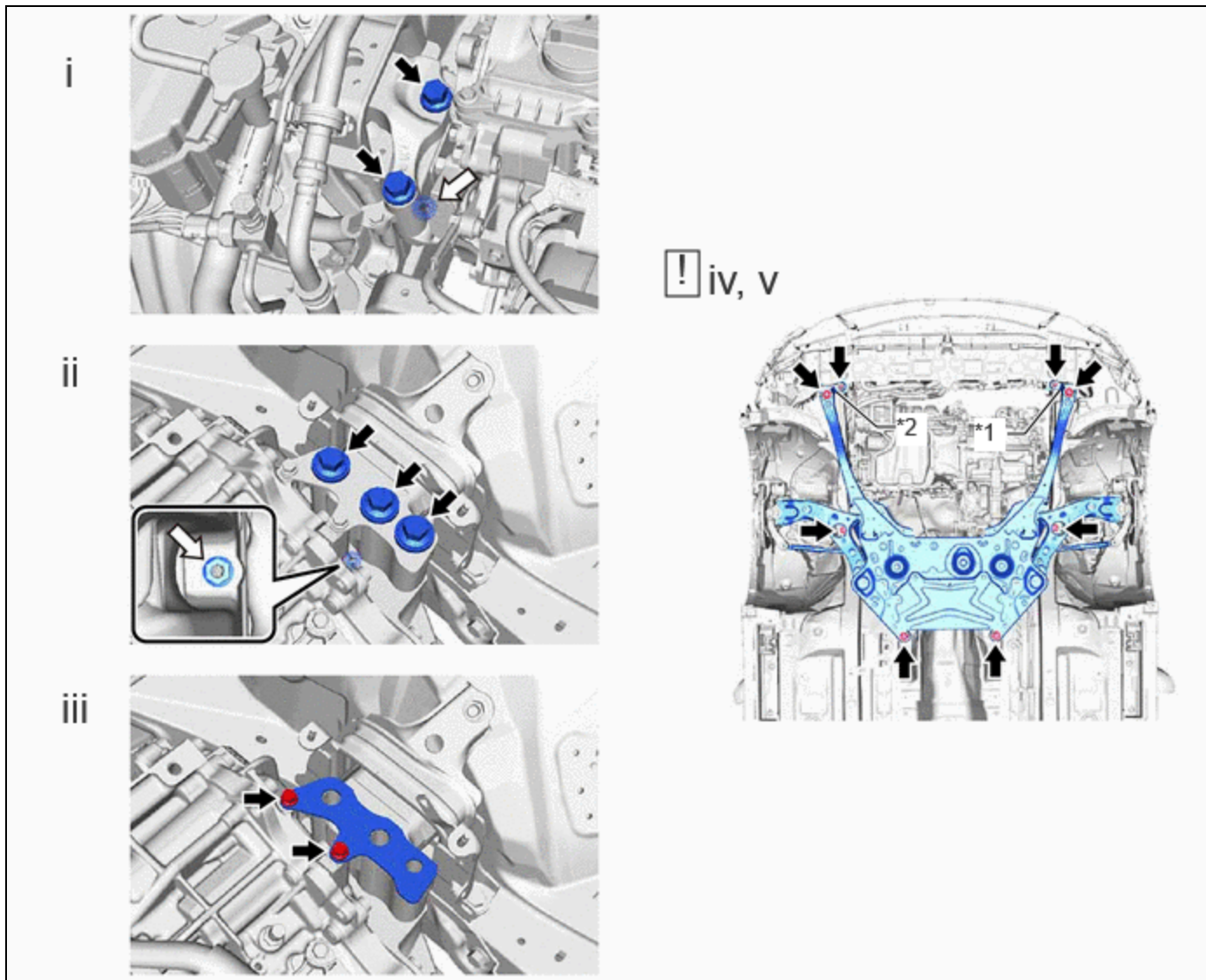
- Using height adjustment attachments and plate lift attachments, keep the engine assembly with transaxle and front suspension crossmember sub-assembly level.
- Do not perform any procedures while the engine assembly is suspended because doing so may cause the engine assembly to drop, resulting in injury. However, the engine assembly needs to be suspended when it is installed to or removed from an engine stand.
- To prevent the engine assembly from unexpectedly moving, securely support the engine assembly until it is secured to an engine stand.
- To prevent the oil pan sub-assembly from deforming, do not place any attachments under the oil pan sub-assembly of the engine assembly with transaxle.



*1	Center Radiator Support LH	*2	Center Radiator Support RH
	Bolt		Nut

- (1) Remove the 2 bolts and nut and separate the engine mounting insulator sub-assembly RH from the engine mounting bracket RH.
- (2) Remove the 3 bolts and nut and separate the engine mounting insulator LH from the hybrid vehicle transaxle assembly.
- (3) Remove the 2 bolts and No. 2 engine mounting stay LH.
- (4) Remove the 8 bolts to separate the front suspension crossmember sub-assembly, center radiator support LH and center radiator support RH from the vehicle.
- (5) Operate the engine lifter and remove the engine assembly with transaxle from the vehicle.

**NOTICE:**

- Make sure that the engine assembly with transaxle is clear of all wiring and hoses.
- While lowering the engine assembly with transaxle from the vehicle, do not allow it to contact the vehicle.

**45. REMOVE ENGINE MOUNTING BRACKET CAP**

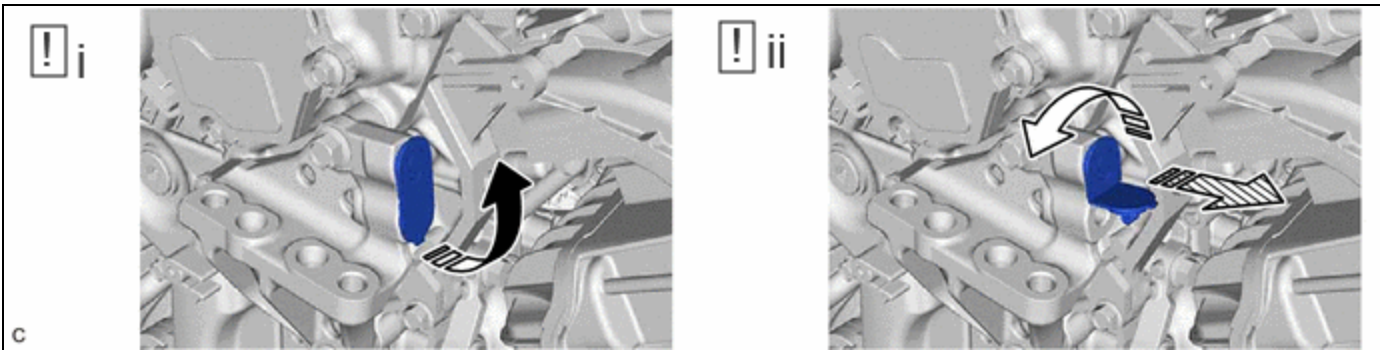

- (1) Turn over the engine mounting bracket cap to the upper part.
- (2) While rotating in the direction shown in the illustration, remove the engine mounting bracket cap.

**46. INSTALL ENGINE HANGERS**



*1	No. 1 Engine Hanger	*2	No. 2 Engine Hanger
----	---------------------	----	---------------------

- (1) Install the No. 1 engine hanger and No. 2 engine hanger with the 4 bolts as shown in the illustration.

**Torque:**

**43 N·m {438 kgf·cm, 32 ft·lbf}**

No. 1 Engine Hanger	12281-25030
No. 2 Engine Hanger	12282-25010
Bolt	91552-F1040

- (2) Attach an engine sling device and hang the engine assembly with transaxle with a chain block.



**NOTICE:**

- Pay attention to the angle of the sling device as the engine assembly or No. 1 engine hanger and No. 2 engine hanger may be damaged or deformed if the angle is incorrect.
- Do not perform any procedure while the engine assembly with transaxle is suspended because doing so may cause the engine assembly with transaxle to drop, resulting in injury. However, the engine assembly with transaxle needs to be suspended when it is installed to or removed from an engine stand.

**47. DISCONNECT ENGINE WIRE**

	Click here <a href="#">INFO</a>
---	---------------------------------

**48. REMOVE STARTER HOLE INSULATOR**Click here [INFO](#)**49. REMOVE FLYWHEEL HOUSING SIDE COVER**Click here [INFO](#)**50. REMOVE ENGINE ASSEMBLY**

	Click here <a href="#">INFO</a>
---	---------------------------------

**51. REMOVE TRANSMISSION INPUT DAMPER ASSEMBLY**

	Click here <a href="#">INFO</a>
---	---------------------------------

**52. REMOVE FLYWHEEL SUB-ASSEMBLY**

	Click here <a href="#">INFO</a>
---	---------------------------------

**53. REMOVE NO. 1 CRANKSHAFT POSITION SENSOR PLATE**Click here [INFO](#)**54. REMOVE COMPRESSOR WITH MOTOR ASSEMBLY**

	Click here <a href="#">INFO</a>
---	---------------------------------

**55. REMOVE FLYWHEEL HOUSING UNDER COVER**

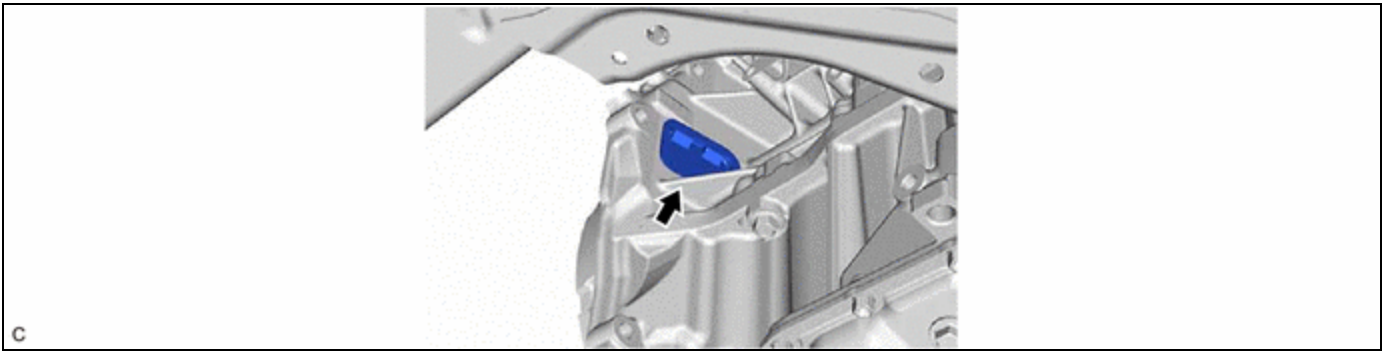

## 56. REMOVE ENGINE WIRE

### HINT:

As the illustration shown is an example, the actual details may differ.

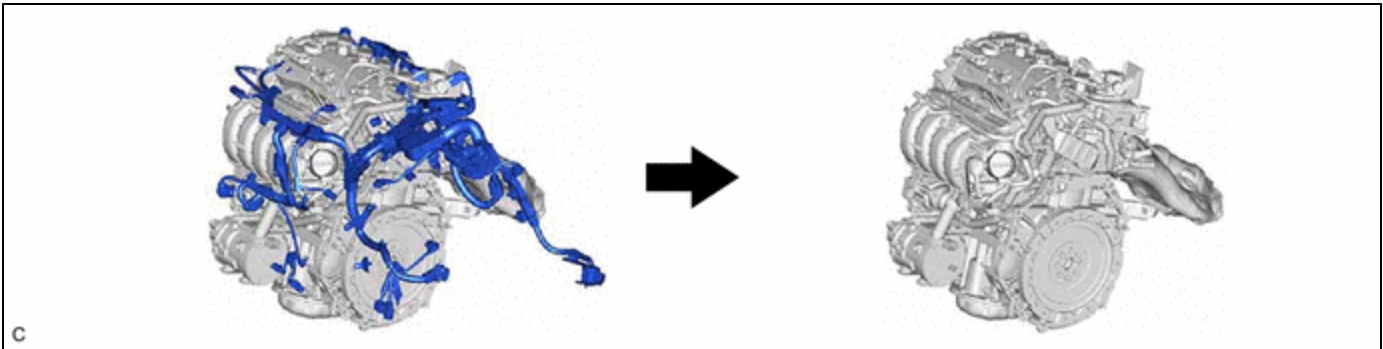

## 57. INSTALL ENGINE ASSEMBLY TO ENGINE STAND



## 58. REMOVE ENGINE HANGERS

## 59. REMOVE ENGINE MOUNTING INSULATOR LH

### HINT:

Perform this procedure only when replacement of the engine mounting insulator LH is necessary.

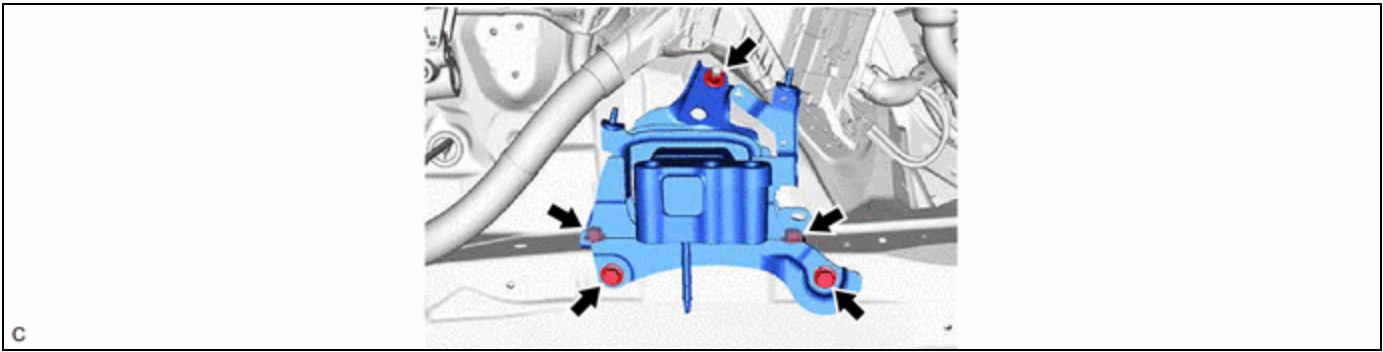

## 60. REMOVE ENGINE MOUNTING INSULATOR SUB-ASSEMBLY RH

### HINT:

Perform this procedure only when replacement of the engine mounting insulator sub-assembly RH is necessary.

