

Last Modified: 12-04-2024	6.11:8.1.0	Doc ID: RM100000029TKE
Model Year Start: 2023	Model: Prius Prime	Prod Date Range: [12/2022 -]
Title: DRIVE SHAFT / PROPELLER SHAFT: REAR DRIVE SHAFT ASSEMBLY: INSTALLATION; 2023 - 2024 MY Prius Prius Prime [12/2022 -]		

INSTALLATION

CAUTION / NOTICE / HINT

HINT:

- Use the same procedure for the RH side and LH side.
- The following procedure is for the LH side.

CAUTION / NOTICE / HINT

COMPONENTS (INSTALLATION)

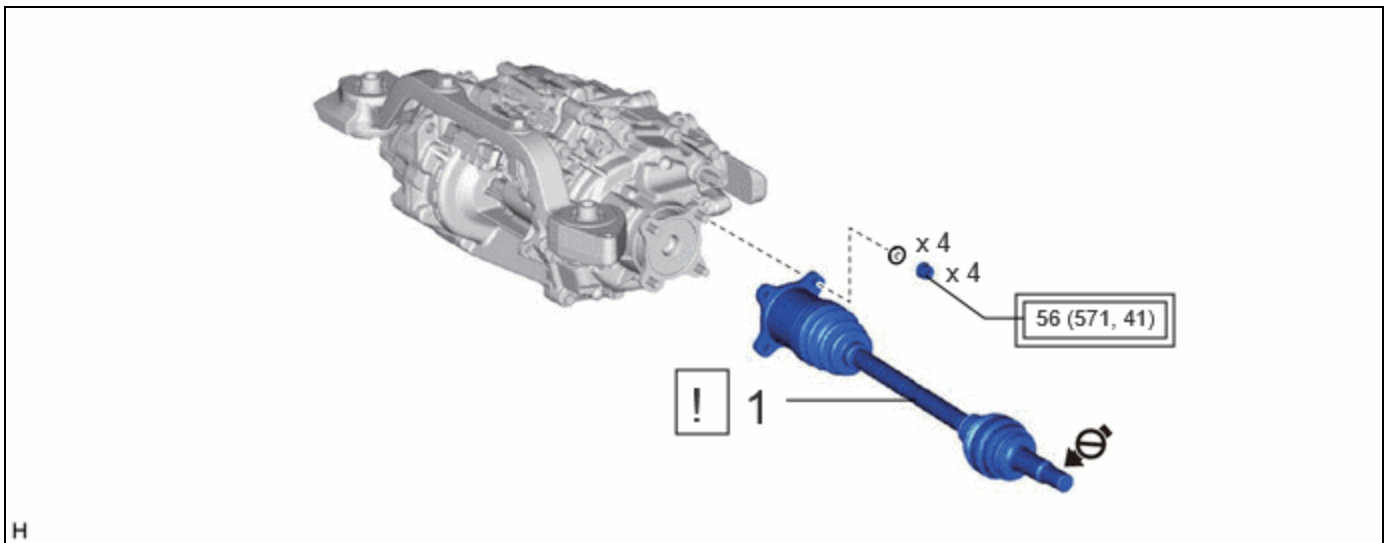

	PROCEDURE	PART NAME CODE			
1	REAR DRIVE SHAFT ASSEMBLY	42340B	INFO	-	-

	Tightening torque for "Major areas involving basic vehicle performance such as moving/turning/stopping": N*m (kgf*cm, ft.*lbf)		Do not apply lubricants to the threaded parts
--	--	--	---

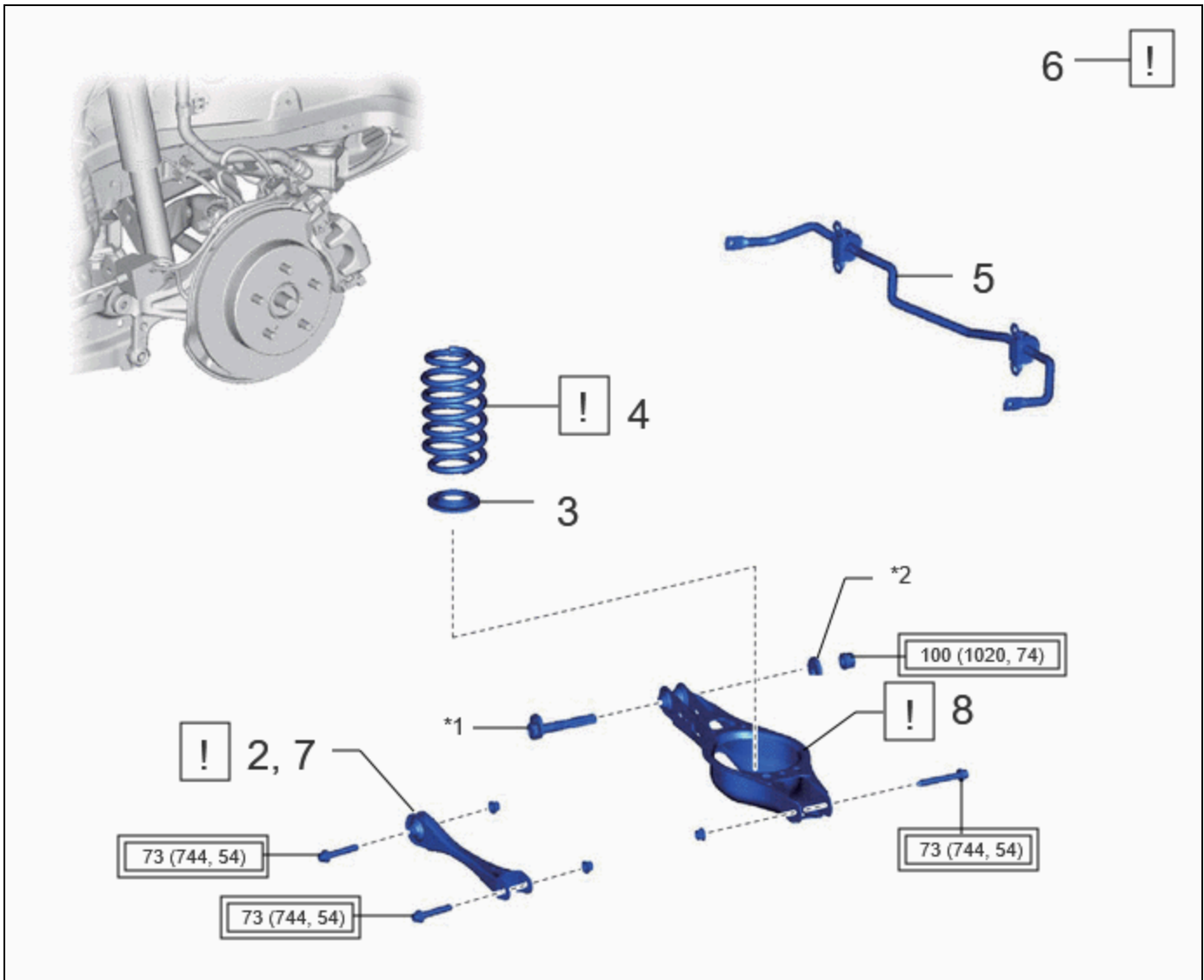





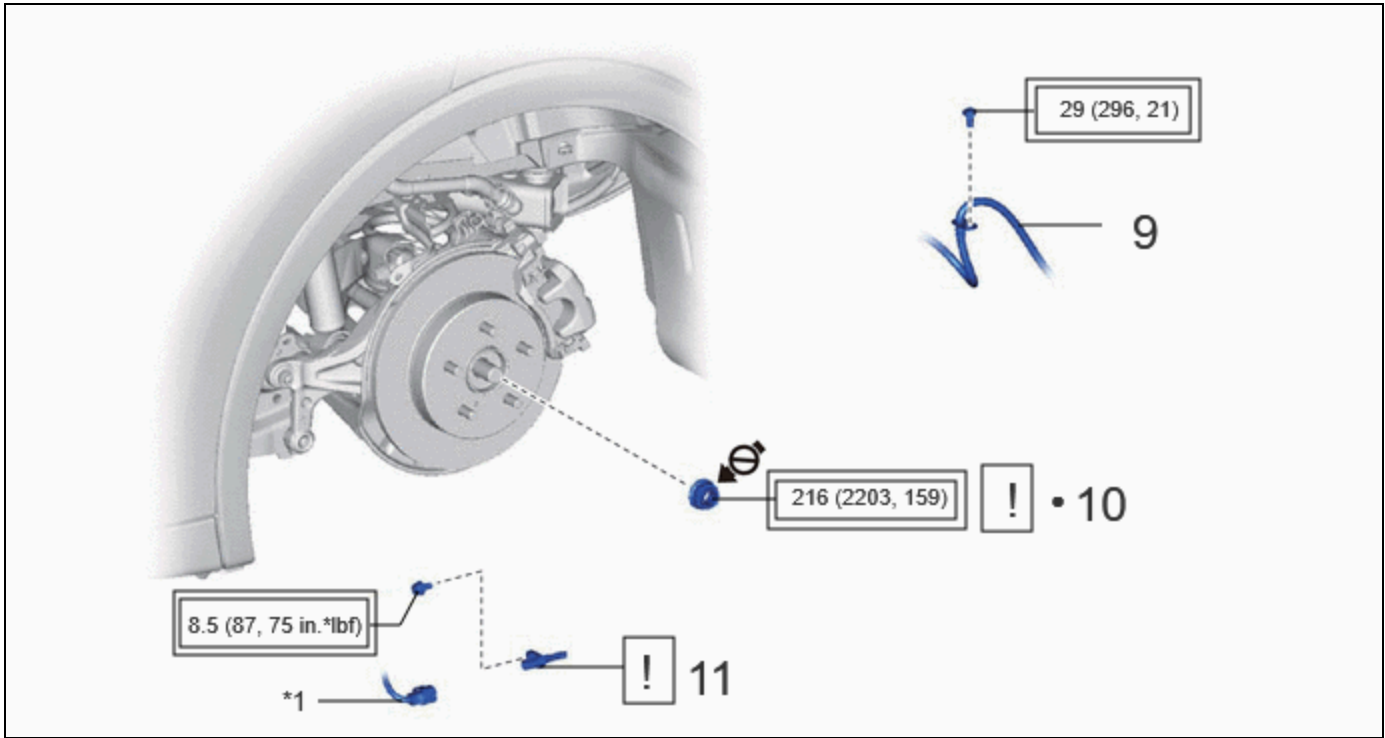

	PROCEDURE	PART NAME CODE	!		
2	TEMPORARILY INSTALL REAR NO. 1 SUSPENSION ARM ASSEMBLY	48720A	INFO	-	-
3	REAR LOWER COIL SPRING INSULATOR	48258C	-	-	-
4	REAR COIL SPRING	48231B	INFO	-	-
5	REAR STABILIZER BAR	48812	-	-	-
6	STABILIZE SUSPENSION	-	INFO	-	-
7	INSTALL REAR NO. 1 SUSPENSION ARM ASSEMBLY	48720A	INFO	-	-
8	REAR NO. 2 SUSPENSION ARM ASSEMBLY	48740F	INFO	-	-

*1	REAR SUSPENSION TOE ADJUST CAM SUB-ASSEMBLY	*2	NO. 2 CAMBER ADJUST CAM
----	---	----	-------------------------

	Tightening torque for "Major areas involving basic vehicle performance such as moving/turning/stopping": N*m (kgf*cm, ft.*lbf)	-	-
---	--	---	---



PROCEDURE		PART NAME CODE			
9	REAR FLEXIBLE HOSE	47319F	-	-	-
10	REAR AXLE SHAFT NUT	42312B		-	-
11	REAR SKID CONTROL SENSOR	89544E		-	-

*1	NO. 2 PARKING BRAKE WIRE ASSEMBLY	-	-
	Tightening torque for "Major areas involving basic vehicle performance such as moving/turning/stopping": N*m (kgf*cm, ft.*lbf)	•	Non-reusable part
	Do not apply lubricants to the threaded parts	-	-

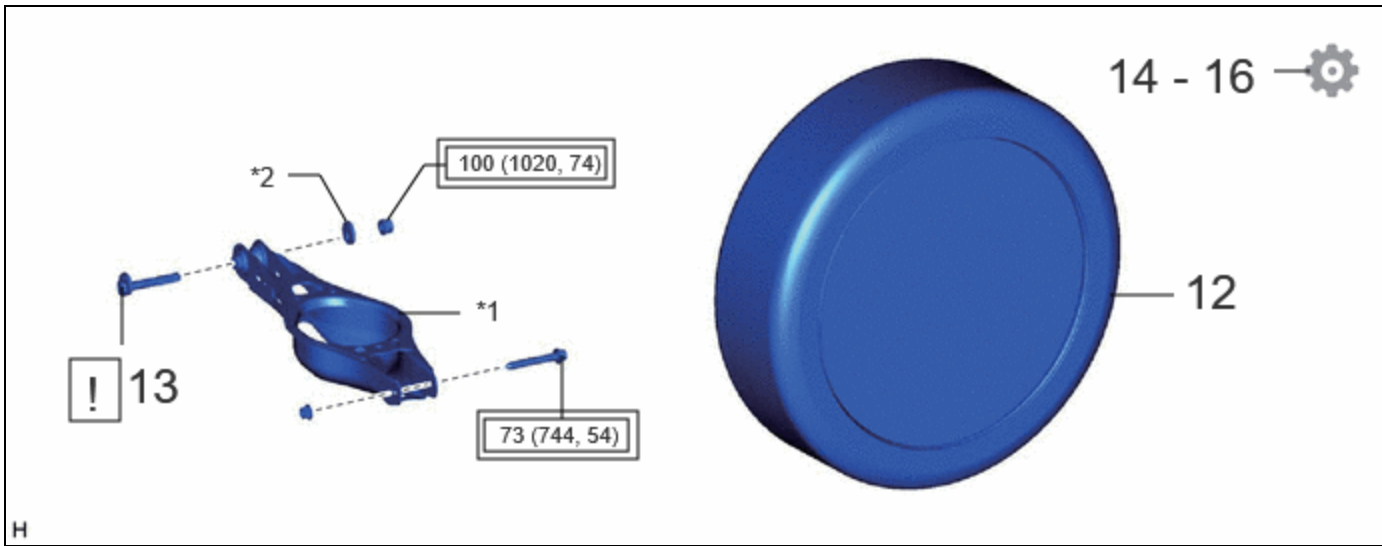

PROCEDURE		PART NAME CODE			
12	REAR WHEEL	-	-	-	-
13	REAR SUSPENSION TOE ADJUST CAM SUB-ASSEMBLY	48409	INFO	-	-
14	INSPECT AND ADJUST REAR WHEEL ALIGNMENT	-	-	-	INFO
15	CHECK FOR SPEED SENSOR SIGNAL	-	-	-	INFO
16	PERFORM INITIALIZATION	-	-	-	INFO

*1	REAR NO. 2 SUSPENSION ARM ASSEMBLY	*2	NO. 2 CAMBER ADJUST CAM
	Tightening torque for "Major areas involving basic vehicle performance such as moving/turning/stopping": N*m (kgf*cm, ft.*lbf)	-	-

PROCEDURE

1. INSTALL REAR DRIVE SHAFT ASSEMBLY

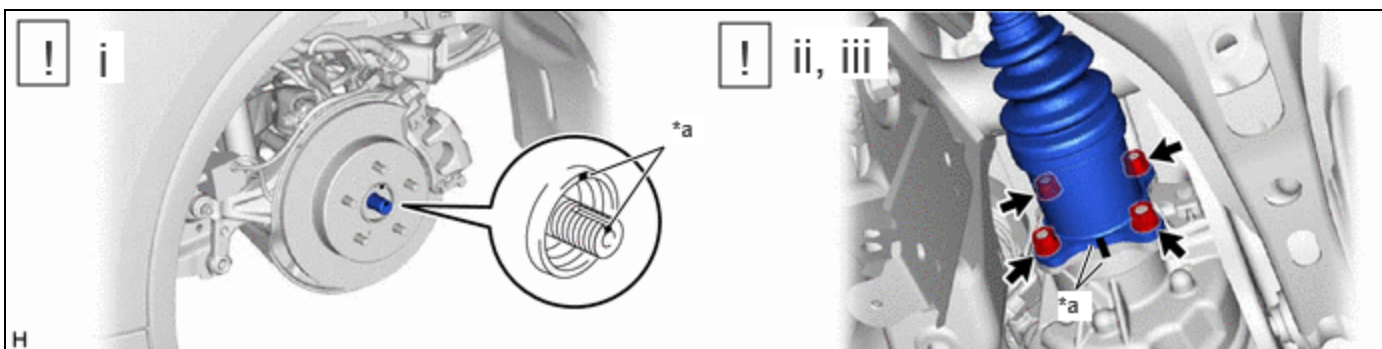

*a	Matchmark	-	-
----	-----------	---	---

(1) Align the matchmarks and install the rear drive shaft assembly to the rear axle hub and bearing assembly.

NOTICE:

- Do not damage the rear drive shaft outboard joint boot.
- Check that there is no foreign matter on the contact surfaces.

(2) Align the matchmarks on the rear drive shaft assembly and differential side gear shaft sub-assembly.

NOTICE:

Do not damage the rear drive shaft inboard joint boot.

(3) Install the 4 nuts and 4 washers.

Torque:

56 N·m {571 kgf·cm, 41 ft·lbf}

2. TEMPORARILY INSTALL REAR NO. 1 SUSPENSION ARM ASSEMBLY

	for AWD LH Side: Click here INFO for AWD RH Side: Click here INFO
--	--

3. INSTALL REAR LOWER COIL SPRING INSULATOR

4. INSTALL REAR COIL SPRING

	Click here INFO
--	---------------------------------

5. INSTALL REAR STABILIZER BAR

Click here [INFO](#)

6. STABILIZE SUSPENSION

	Click here INFO
--	---------------------------------

7. INSTALL REAR NO. 1 SUSPENSION ARM ASSEMBLY

	for AWD LH Side: Click here INFO for AWD RH Side: Click here INFO
--	--

8. INSTALL REAR NO. 2 SUSPENSION ARM ASSEMBLY

	for AWD LH Side: Click here INFO for AWD RH Side: Click here INFO
--	--

9. INSTALL REAR FLEXIBLE HOSE

Click here [INFO](#)

10. INSTALL REAR AXLE SHAFT NUT

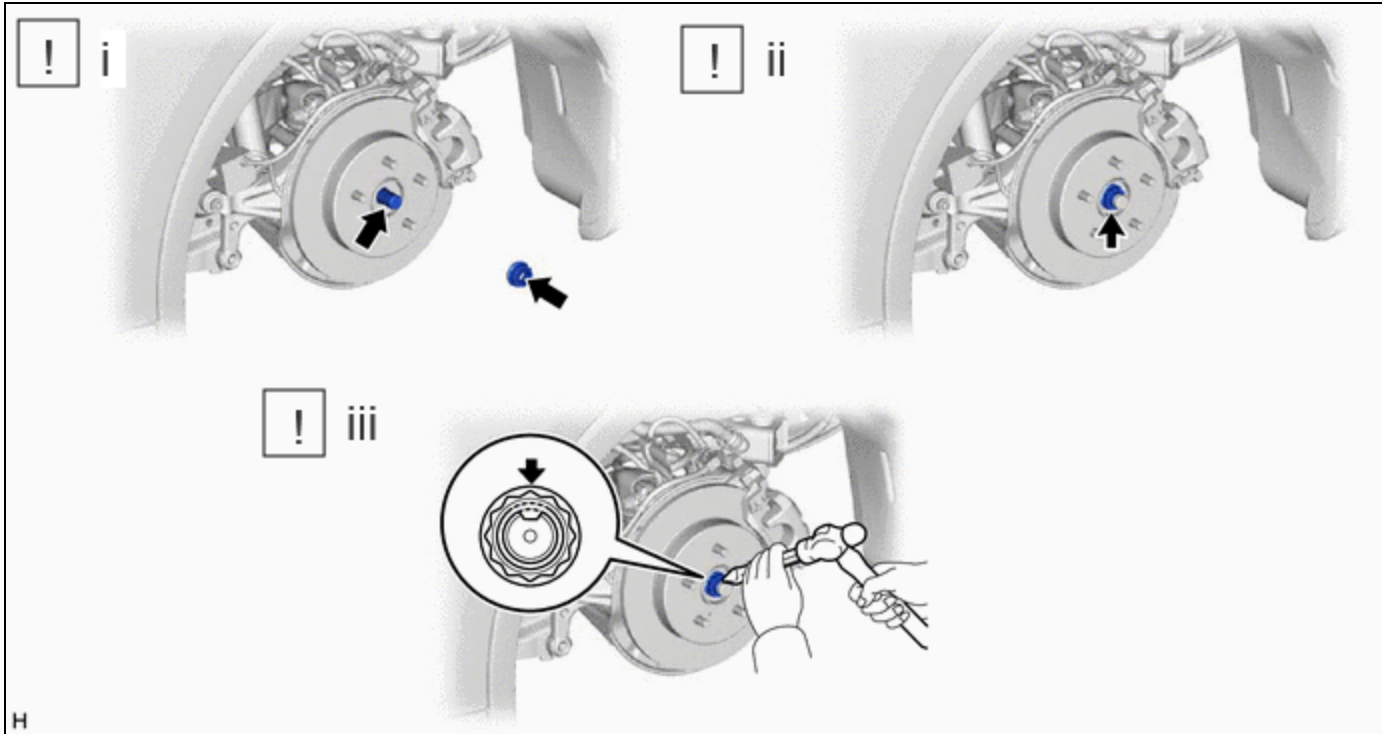

(1) Clean the threaded parts on the rear drive shaft assembly and a new rear axle shaft nut using non-residue solvent.

NOTICE:

- Be sure to perform this work even when using a new rear drive shaft assembly.
- Keep the threaded parts free of oil and foreign matter.

(2) Using a 30 mm deep socket wrench, install the rear axle shaft nut while applying the brakes.

Torque:

216 N·m {2203 kgf·cm, 159 ft·lbf}

(3) Using a chisel and a hammer, stake the rear axle shaft nut.

11. INSTALL REAR SKID CONTROL SENSOR

	Click here INFO
--	---------------------------------

12. INSTALL REAR WHEEL

Click here [INFO](#)

13. INSTALL REAR SUSPENSION TOE ADJUST CAM SUB-ASSEMBLY

	for AWD LH Side: Click here INFO for AWD RH Side: Click here INFO
--	--

14. INSPECT AND ADJUST REAR WHEEL ALIGNMENT

Click here [INFO](#)

15. CHECK FOR SPEED SENSOR SIGNAL

Click here [INFO](#)

16. PERFORM INITIALIZATION

Parking Assist Monitor System	INFO
Panoramic View Monitor System	INFO
Advanced Park	INFO

