

Last Modified: 12-04-2024	6.11:8.1.0	Doc ID: RM10000002BJ82
Model Year Start: 2023	Model: Prius Prime	Prod Date Range: [03/2023 -]
Title: CELLULAR COMMUNICATION: TELEPHONE AND GPS ANTENNA (for Front Side): REMOVAL; 2023 - 2024 MY Prius Prius Prime [03/2023 -]		

REMOVAL

CAUTION / NOTICE / HINT

The necessary procedures (adjustment, calibration, initialization or registration) that must be performed after parts are removed and installed, or replaced during telephone and GPS antenna assembly removal/installation are shown below.

CAUTION:

Be sure to read Precaution thoroughly before servicing.



[Click here](#) INFO

NOTICE:

After the ignition switch is turned off, there may be a waiting time before disconnecting the negative (-) auxiliary battery terminal.

[Click here](#) INFO

HINT:

When the cable is disconnected / reconnected to the auxiliary battery terminal, systems temporarily stop operating. However, each system has a function that completes learning the first time the system is used.

Learning completes when vehicle is driven

EFFECT/INOPERATIVE FUNCTION WHEN NECESSARY PROCEDURE NOT PERFORMED	NECESSARY PROCEDURE	LINK
Front Camera System	Drive the vehicle straight ahead at 35 km/h (22 mph) or more for 5 seconds or more.	INFO



Learning completes when vehicle is operated normally

EFFECT/INOPERATIVE FUNCTION WHEN NECESSARY PROCEDURE NOT PERFORMED	NECESSARY PROCEDURE	LINK
Power Door Lock Control System*1 <ul style="list-style-type: none"> Back door opener 	Perform door unlock operation with door control switch or electrical key transmitter sub-assembly switch.	INFO
Power Back Door System*2	Reset back door close position	INFO
Air Conditioning System	<p>for HEV Model:</p> <p>After the ignition switch is turned to ON, the servo motor standard position is recognized.</p> <p>for PHEV Model:</p> <p>After the ignition switch is turned to ON, the servo motor and expansion valve standard position is recognized.</p>	-
<p>*1: w/o Power Back Door System</p> <p>*2: w/ Power Back Door System</p>		

CAUTION / NOTICE / HINT

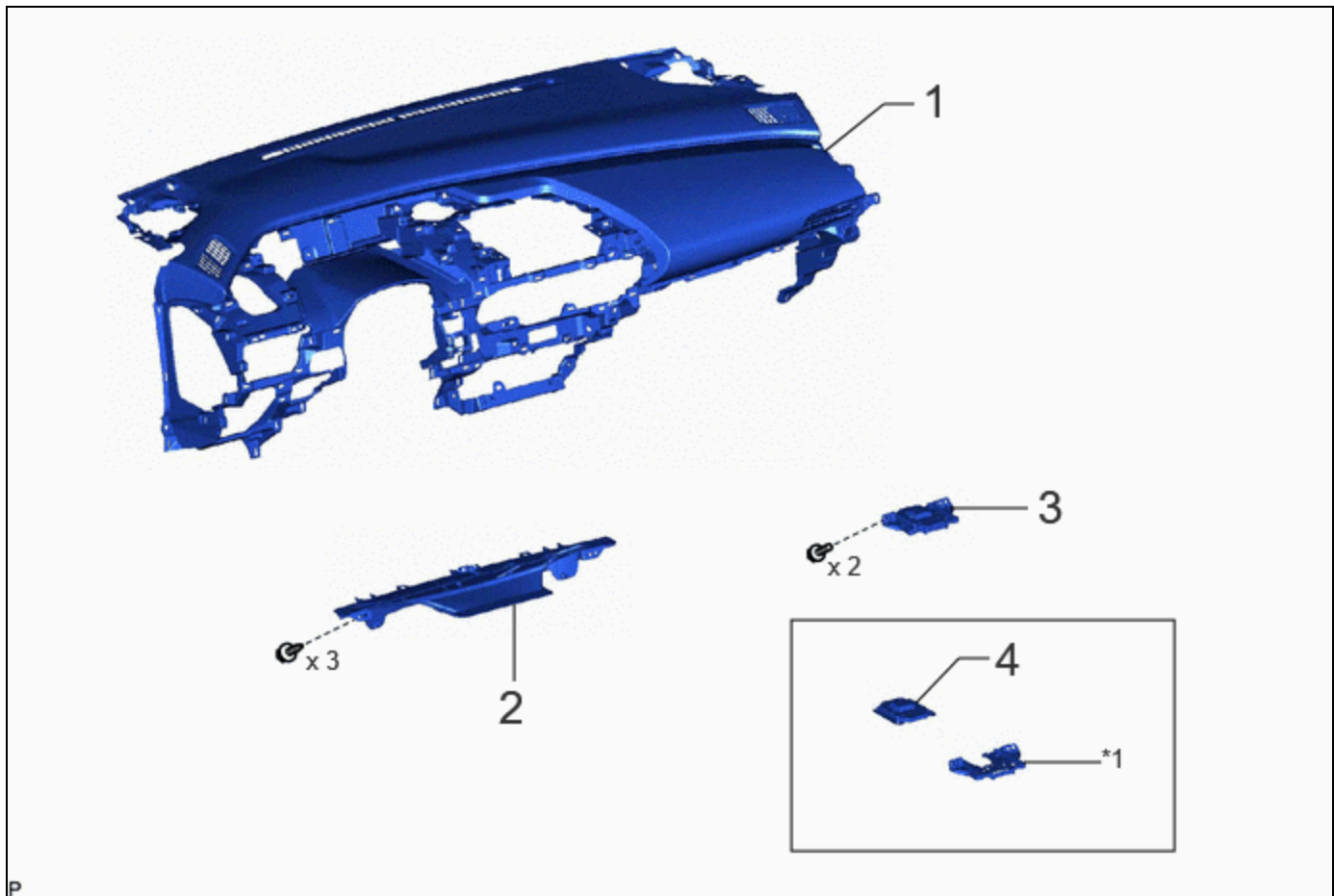
COMPONENTS (REMOVAL)



PROCEDURE	PART NAME CODE			
1 INSTRUMENT PANEL SAFETY PAD SUB-ASSEMBLY	-	-	-	-
2 DEFROSTER NOZZLE ASSEMBLY	55950G	-	-	-
3 TELEPHONE AND GPS ANTENNA ASSEMBLY WITH BRACKET	-	-	-	-
4 TELEPHONE AND GPS ANTENNA ASSEMBLY	86860	-	-	-

*1	TELEPHONE AND GPS ANTENNA BRACKET	-	-
----	-----------------------------------	---	---

PROCEDURE

1. REMOVE INSTRUMENT PANEL SAFETY PAD SUB-ASSEMBLY

Click here [INFO](#)

2. REMOVE DEFROSTER NOZZLE ASSEMBLY

Click here [INFO](#)

3. REMOVE TELEPHONE AND GPS ANTENNA ASSEMBLY WITH BRACKET

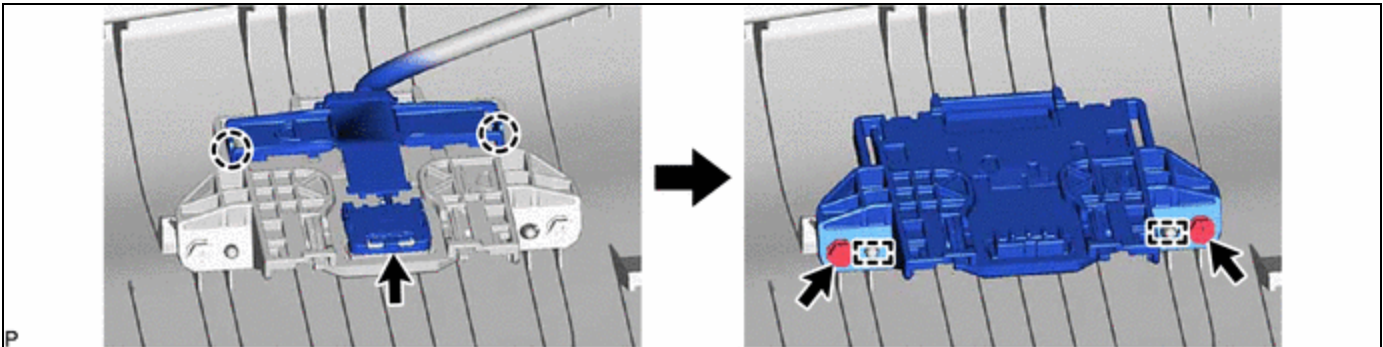

4. REMOVE TELEPHONE AND GPS ANTENNA ASSEMBLY

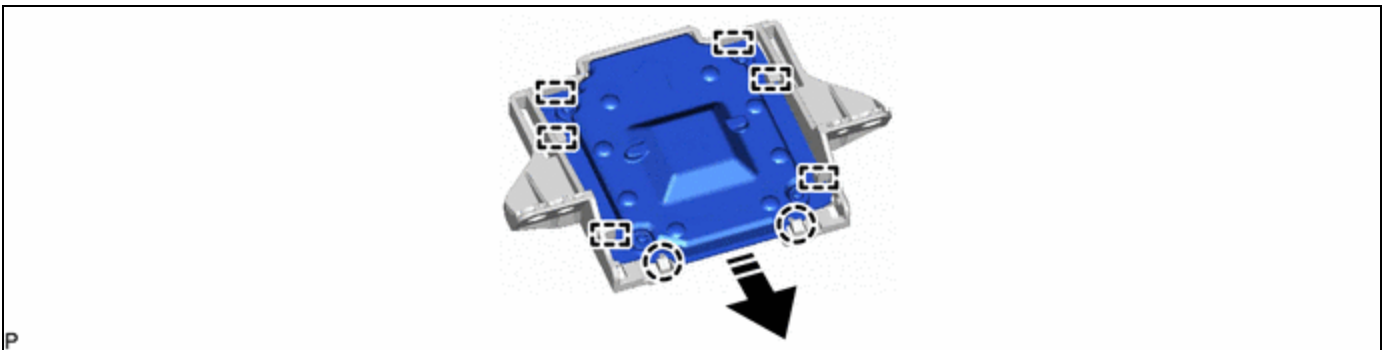

	Remove in this Direction	-	-
---	--------------------------	---	---

