

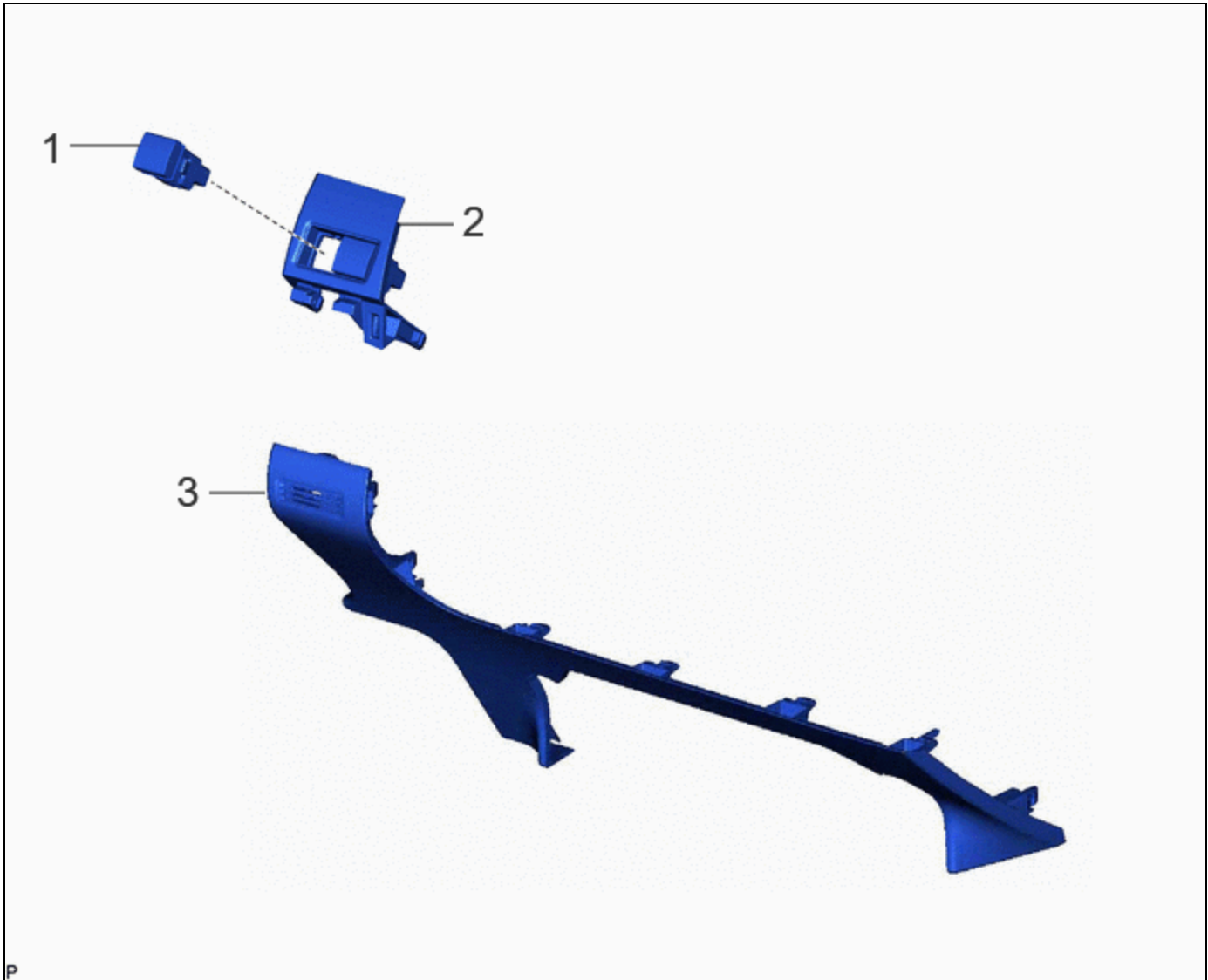



Last Modified: 12-04-2024	6.11:8.1.0	Doc ID: RM1000000029ETU
Model Year Start: 2023	Model: Prius Prime	Prod Date Range: [12/2022 -]
Title: ADVANCED PARK: ADVANCED PARK MAIN SWITCH: INSTALLATION; 2023 - 2024 MY Prius Prius Prime [12/2022 -]		



INSTALLATION

CAUTION / NOTICE / HINT

COMPONENTS (INSTALLATION)



PROCEDURE		PART NAME CODE			
1	IPA MAIN SWITCH ASSEMBLY	84490D	-	-	-

	PROCEDURE	PART NAME CODE			
2	LOWER CENTER INSTRUMENT CLUSTER FINISH PANEL SUB-ASSEMBLY	55406B	-	-	-
3	LOWER CENTER INSTRUMENT PANEL FINISH PANEL	55434B	-	-	-

PROCEDURE

1. INSTALL IPA MAIN SWITCH ASSEMBLY

2. INSTALL LOWER CENTER INSTRUMENT CLUSTER FINISH PANEL SUB-ASSEMBLY

3. INSTALL LOWER CENTER INSTRUMENT PANEL FINISH PANEL

