

Supplement to operator's manual

TruConvert System Control

Grid codes

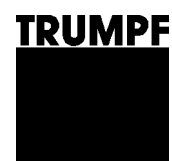

**Supplement to opera-
tor's manual**

TruConvert System Control

Grid codes

Edition **2023-01-24**

Order Information

Please specify when ordering this document:

Supplement to operator's manual

TruConvert System Control

Edition 2023-01-24

Document number A67-0146-00.BKen-001-04

Address for orders

TRUMPF Hüttinger GmbH + Co. KG

Technische Redaktion

Bötzingen Straße 80

D-79111 Freiburg

Fon: +49 761 8971 - 0

Fax: +49 761 8971 - 1150

Internet: <http://www.trumpf-huettinger.com>

E-Mail: info.elektronik@de.trumpf.com

Good to know

Need help? Provide the **serial number** when you contact the Service department.

How to reach our Service department:

Telephone +49 761 8971-2170

Fax +49 761 8971-1178

E-Mail service.electronic@trumpf.com

Table of contents

1	Introduction	8
1.1	Making necessary presettings	8
1.2	Selecting AC grid	9
1.3	Selecting grid code	9
1.4	Adopting grid code settings in system	10
1.5	Showing selected grid code	10
1.6	Displaying status of power limiting	10
1.7	Changing parameters	11
2	UL1741SA	12
2.1	Hierarchy of the grid code functions	12
2.2	Low and high voltage ride through (SA9)	12
	Switching on "FRT voltage mode"	12
2.3	Low and high frequency ride through (SA10)	14
	Switching on "FRT frequency mode"	14
2.4	Volt-Watt mode (SA15)	16
	Switching on "P(U) mode"	18
2.5	Frequency-Watt mode (SA14)	20
	Switching on "P(f) mode"	21
2.6	Volt/Var mode (SA13)	23
	Switching on "Volt/Var mode"	23
2.7	Specified power factor (SA12)	25
	Setting the Specified power factor	25
2.8	Normal ramp rate and soft-start ramp rate (SA11)	26
	Adjust Normal ramp rate and soft-start ramp rate	26
2.9	Anti-islanding protection (SA8)	26
	Switching on Anti-islanding protection	26
2.10	Switch-on criteria "Switch on criteria"	27
	Setting switch-on/switch-off conditions	27
3	ARN4105	28
3.1	Hierarchy of the grid code functions	28
3.2	Anti-islanding protection	29
	Switching on Anti-islanding protection	29

3.3	Dynamic grid support "RT voltage mode"	29
	Function description "RT voltage mode"	29
	Switching on "RT voltage mode"	31
	Parameterization "RT voltage mode"	31
	More information about "RT voltage mode"	31
3.4	Bypass	33
	Description of functions "Bypass"	33
	Switching on "Bypass"	33
	Parameterization "Bypass"	33
3.5	Effective power matching in the event of overfrequency and underfrequency "P(f) mode"	34
	Function description "P(f) mode"	34
	Switching on "P(f) mode"	35
	Parameterization "P(f) mode"	35
	More information about "P(f) mode"	38
3.6	Static voltage stability/provision of reactive power "Q modes"	39
	Reactive power as a function of the grid voltage: "Q(U)"	39
	Fixed power factor "Constant cosPhi"	42
	Power factor as a function of effective power "cosPhi(P)"	44
3.7	Step response "Step response for Q"	46
	Function description "Step response for Q"	46
	Switching on "Step response for Q"	46
	Parameterization "Step response for Q"	46
3.8	Switch-on criteria "Switch on criteria"	47
	Function description "Switch on criteria"	47
	Switching on "Switch on criteria"	48
	Parameterization "Switch on criteria"	48
3.9	Startup ramp "Startup ramp"	48
	Function description "Startup ramp"	48
	Switching on "Startup ramp"	49
	Parameterization "Startup ramp"	49
	More information about "Startup ramp"	49
3.10	Power limiter "Active power limiting"	50
	Function description "Active power limiting"	50
	Switching on "Active power limiting"	50
	Parameterization "Active power limiting"	50

4	ARN4110	52
4.1	Prerequisites for complying with ARN4110	52
	Certified regulator	53
	Measurement technology at the point of common coupling (PCC)	54
	Grid- and system-protection	55
	Grid-side switch (CB1)	56
	Auxiliary supply	56
	Reactive power capacity when using ARN4110	57
4.2	Hierarchy of the grid code functions	59
4.3	Dynamic grid support "RT voltage mode"	59
	Function description "RT voltage mode"	59
	Switching on "RT voltage mode"	63
	Parameterization "RT voltage mode"	63
	More information about "RT voltage mode"	64
4.4	Effective power matching in the event of overfrequency and underfrequency "P(f) mode"	65
	Function description "P(f) mode"	65
	Switching on "P(f) mode"	67
	Parameterization "P(f) mode"	67
	More information about "P(f) mode"	69
4.5	Switch-on criteria "Switch on criteria"	71
	Function description "Switch on criteria"	71
	Switching on "Switch on criteria"	71
	Parameterization "Switch on criteria"	71
5	EN50549-1	73
5.1	Hierarchy of the grid code functions	73
5.2	Anti-islanding protection	74
	Switching on Anti-islanding protection	74
5.3	Dynamic grid support "RT voltage mode"	74
	Function description "RT voltage mode"	74
	Switching on "RT voltage mode"	76
	Parameterization "RT voltage mode"	76
	More information about "RT voltage mode"	76
5.4	Bypass	78
	Description of functions "Bypass"	78
	Switching on "Bypass"	78
	Parameterization "Bypass"	78

5.5	Effective power matching in the event of overfrequency and underfrequency "P(f) mode"	79
	Function description "P(f) mode"	79
	Switching on "P(f) mode"	80
	Parameterization "P(f) mode"	81
	More information about "P(f) mode"	84
5.6	Effective power matching in the event of overvoltage "P(U) mode"	85
	Function description "P(U) mode"	85
	Switching on "P(U) mode"	87
	Parameterization "P(U) mode"	87
	More information about "P(U) mode"	88
5.7	Static voltage stability/provision of reactive power "Q modes"	89
	Reactive power as a function of the grid voltage: "Q(U)"	89
	Fixed power factor "Constant cosPhi"	93
	Power factor as a function of effective power "cosPhi(P)"	94
	Constant provision of reactive power "Q = const"	96
5.8	Step response "Step response for Q"	97
	Function description "Step response for Q"	97
	Switching on "Step response for Q"	98
	Parameterization "Step response for Q"	98
5.9	Switch-on criteria "Switch on criteria"	99
	Function description "Switch on criteria"	99
	Switching on "Switch on criteria"	99
	Parameterization "Switch on criteria"	100
5.10	Startup ramp "Startup ramp"	100
	Function description "Startup ramp"	100
	Switching on "Startup ramp"	100
	Parameterization "Startup ramp"	101
	More information about "Startup ramp"	101
5.11	Power limiter "Active power limiting"	101
	Function description "Active power limiting"	101
	Switching on "Active power limiting"	102
	Parameterization "Active power limiting"	102
6	TOR type A	103
6.1	Hierarchy of the grid code functions	103

6.2	Anti-islanding protection	104
	Switching on Anti-islanding protection	104
6.3	Dynamic grid support "RT voltage mode"	104
	Function description "RT voltage mode"	104
	Switching on "RT voltage mode"	106
	Parameterization "RT voltage mode"	106
	More information about "RT voltage mode"	106
6.4	Bypass	108
	Description of functions "Bypass"	108
	Switching on "Bypass"	108
	Parameterization "Bypass"	108
6.5	Effective power matching in the event of overfrequency	109
	Function description "P(f) mode"	109
	Switching on "P(f) mode"	110
	Parameterization "P(f) mode"	110
	More information about "P(f) mode"	111
6.6	Effective power matching in the event of overvoltage "P(U) mode"	113
	Function description "P(U) mode"	113
	Switching on "P(U) mode"	115
	Parameterization "P(U) mode"	115
	More information about "P(U) mode"	116
6.7	Static voltage stability/provision of reactive power "Q modes"	117
	Reactive power as a function of the grid voltage: "Q(U)"	118
	Fixed power factor "Constant cosPhi"	121
	Power factor as a function of effective power "cosPhi(P)"	122
	Constant provision of reactive power "Q = const"	124
6.8	Step response "Step response for Q"	125
	Function description "Step response for Q"	125
	Switching on "Step response for Q"	126
	Parameterization "Step response for Q"	126
6.9	Switch-on criteria "Switch on criteria"	127
	Function description "Switch on criteria"	127
	Switching on "Switch on criteria"	127
	Parameterization "Switch on criteria"	128
6.10	Startup ramp "Startup ramp"	128
	Function description "Startup ramp"	128
	Switching on "Startup ramp"	128

	Parameterization "Startup ramp"	129
	More information about "Startup ramp"	129
6.11	Power limiter "Active power limiting"	129
	Function description "Active power limiting"	129
	Switching on "Active power limiting"	130
	Parameterization "Active power limiting"	130
7	AS/NZS 4777.2	131
7.1	Hierarchy of the grid code functions	131
7.2	Anti-islanding protection	132
	Switching on Anti-islanding protection	132
7.3	Regional settings ("Regional settings")	132
	Select "Regional settings"	133
7.4	"Voltage limit mode" (passive anti islanding protection)	133
	Function description "Voltage limit mode"	133
	Switching on "Voltage limit mode"	135
	Parameterization "Voltage limit mode"	135
	More information about "Voltage limit mode"	135
7.5	Frequency limit mode (passive anti islanding protection)	137
	Function description "Frequency limit mode"	137
	Switching on "Frequency limit mode"	138
	Parameterization "Frequency limit mode"	138
7.6	Sustained operation voltage mode	139
	Function description "Sustained operation voltage mode"	139
	Switching on "Sustained operation voltage mode"	139
	Parameterization "Sustained operation voltage mode"	140
7.7	"P(f): Sustained operation frequency mode"	140
	Function description "P(f): Sustained operation frequency mode"	140
	Switching on "P(f): Sustained operation frequency mode"	142
	Parameterization "P(f): Sustained operation frequency mode"	142
7.8	P(U): Volt-watt response modes	144
	Function description "P(U): Volt-watt response modes"	144

	Switching on "P(U): Volt-watt response modes"	145
	Parameterization "P(U): Volt-watt response modes"	145
	More information about "P(U): Volt-watt response modes"	146
7.9	Static voltage stability/provision of reactive power "Q modes"	147
	Q(U): Volt-var response mode	147
	Constant cosPhi: Fixed power factor mode	149
	Constant Q: Reactive power mode	151
7.10	Switch-on criteria "Switch on criteria"	152
	Function description "Switch on criteria"	152
	Switching on "Switch on criteria"	152
	Parameterization "Switch on criteria"	153
	More information about "Switch on criteria"	153
7.11	Startup ramp "Startup ramp"	154
	Function description "Startup ramp"	154
	Switching on "Startup ramp"	154
	Parameterization "Startup ramp"	154
	More information about "Startup ramp"	155

1. Introduction

Grid codes define rules that generation systems must obey in order to gain access to the mains grid. In particular, these rules regulate behavior in the event of grid fluctuations.

The grid operator determines the behavior of systems in the event of undervoltage, overvoltage and frequency deviation, and also defines the connect and disconnect conditions.

1.1 Making necessary presettings

Before the grid codes are configured, the following presettings must be made.

Conditions

- Initial commissioning was performed, see operating instructions, chapter "Operation", "Initial commissioning".
- Password for grid codes was requested from TRUMPF service.

Note

In order for a grid code to function properly, configuration must be performed once during commissioning.

With a newly delivered device (factory setting), no grid code is active.

NOTICE

Do not change grid codes without authorization!

This results in the immediate cancellation of the operating authorization and of the product guarantee of the TruConvert system.

- The configuration of the grid codes is to be agreed upon, implemented and documented together with the grid operator prior to connection.
- During operation, the conditions (grid codes, TAB) on which the decisions regarding the connection of the generating system and/or of the accumulator were based may **only** be changed with the consent of the grid operator.
- The settings for the grid codes are password protected.

-
- Create a configuration for the following points:
 - Selecting AC grid (see ["Selecting AC grid"](#), pg. 9)
 - Selecting grid code (see ["Selecting grid code"](#), pg. 9)



- Adopting grid code settings in system (see "Adopting grid code settings in system", pg. 10)
- Showing selected grid code (see "Showing selected grid code", pg. 10)
- Displaying status of power limiting (see "Displaying status of power limiting", pg. 10)

Tip

To query the current status of the configuration, the `>GRID CODE` menu item and the corresponding selection list of the grid codes can also be opened without entering the password.

1.2 Selecting AC grid

Note

All entries made via the web GUI must be subsequently confirmed: Press key ↵.

1. Switch AC-DC module to idle operation:
 - Select `>Operation >Device control AC-DC mode`.
 - For "Activate power stage" enter 0.

The following is displayed in the status bar: "Divice status: Idle". The device is idling and can now be configured.

2. To ensure that the settings apply to all AC-DC modules:
For "Slave module selection" enter "0".
3. Change to the `>AC-DC module settings` submenu.
4. In the "AC settings" area under "Grid type selection": Select the AC grid available for the operating environment.

1.3 Selecting grid code

Selecting grid code

1. Select `>Configuration >System configuration`.
2. In the "Grid code configuration" area under "Password", enter the password for editing the grid codes.

Additional input fields are displayed.

3. In the "Grid code configuration" area under "Select grid code", select the desired grid code.

The selected grid code must correspond to the previously selected AC grid.

The selected grid code is displayed as an additional submenu item in the submenu.

4. Select *>Configuration >"Grid code xxx"*.
5. Set the parameters for the selected grid code.

The individual functions are described separately in the following.

1.4 Adopting grid code settings in system

Adopting grid code settings in system

Note

After entering the password, there is a time window of 15 min in which the parameters can be set and permanently stored.

If the parameters are not stored until after the window has elapsed, they are only applied for the current operation. After a 24 V reset, restart of the CPU or a software update, the settings are lost.

- To save the changes:
 - Select *>Configuration >System configuration*.
 - In the "Grid code configuration" area, click on "Save grid code settings".

1.5 Showing selected grid code

Showing selected grid code

- Select *>Operation >System configuration*.

The selected grid code is displayed in the *>Grid code configuration* area by *>Active grid code*.

1.6 Displaying status of power limiting

Displaying status of power limiting

During operation, the "Power limiting status" in *>Operation >Device control AC-DC mode* menu indicates whether the power is currently limited and what the reason for limiting is.

Status	Meaning
"inactive"	No power limiting.
"DC link limiting controller"	DC link limiting controller is active.
"Grid code"	A grid code function is active.
"Overload limiting"	Overload limiting is active.
"Temperature derating"	Temperature limits power output.

Status of power limiting

Tab. 1

1. Select *>Operation >Device control AC-DC mode*.
2. Read off the current status in the *>Device control AC-DC* area under "Power limiting status".

1.7 Changing parameters

Most parameters can only be changed if the AC-DC module is idling.

Note

All entries made via the web GUI must be subsequently confirmed: Press key ↵.

1. Switch AC-DC module to idle operation:
 - Select *>Operation >Device control AC-DC mode*.
 - For "Activate power stage" enter 0.

The following is displayed in the status bar: "Divice status: Idle". The device is idling and can now be configured.

2. To ensure that the settings apply to all AC-DC modules:
For "Slave module selection" enter "0".

2. UL1741SA

2.1 Hierarchy of the grid code functions

If several grid code functions are active at the same time, the function with the highest hierarchy level takes control. Functions of the same hierarchy level have the same ability to intervene.

Hierarchy	Abbreviation of the function	Name of the function	SA
0	Anti-islanding	Anti-islanding protection	8
1	FRT voltage	Low and high voltage ride through	9
1	FRT frequency	Low and high frequency ride through	10
2	P(U)	Volt-Watt	15
3	P(f)	Frequency-Watt	14
4	Q(U)	Volt/Var mode	13
5	SPF cos(Phi)	Specified power factor	12
5	Ramp rate	Normal ramp rate and soft-start ramp rate	11

Hierarchy of the grid code functions

Tab. 2

2.2 Low and high voltage ride through (SA9)

Switching on "FRT voltage mode"

The "FRT voltage mode" function controls the behavior of the AC-DC module in the event of undervoltage and overvoltage on the mains grid. The AC-DC module remains connected to the mains for a preset period of time and then disconnects from the mains. The alarm message is displayed: "Grid code ride through time exceeded".

Activate "FRT voltage mode"

1. To switch on the function:
 - In the main menu, click on *>GRID CODE*.
 - Select the grid code in the selection list: "UL1741SA FRTs".
2. In the "Fault ride through mode" area under "Activate FRT voltage mode", select: "FRT voltage mode"

The function is switched on.

Enter parameters for "FRT voltage mode"

In order to support the mains grid, 6 operating ranges are defined:

- Undervoltage: 3 ranges
- Nominal voltage ("Near Nominal"): 1 range
- Overvoltage: 2 ranges

If the mains voltage is in the nominal voltage range, the AC-DC module behaves normally.

If the mains voltage is in one of the undervoltage or overvoltage ranges, some entries made by the user will be ignored because the mains-supporting measures have priority.

A time period can be defined for each undervoltage and overvoltage range.

For each range, it is additionally possible to specify which mode the AC-DC module is to remain in while connected to the mains:

- "Mandatory operation"
The AC-DC module attempts to maintain the output apparent power.
- "Momentary cessation"
The AC-DC module reduces the output apparent power to 0.

In both modes, the AC-DC module attempts to maintain the power factor and phase position (inductive/capacitive). If one of the modes is active, these values cannot be changed.

All 3 phases are considered separately.

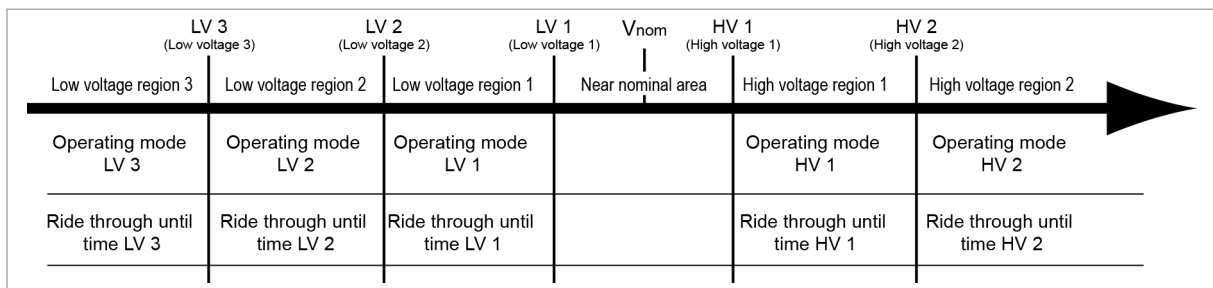

Possible voltage ranges and the corresponding parameters

Fig. 1

Parameter	Unit	Step size	Default	Minimum	Maximum
Low voltage 3	V	0.01	138.5	120	276
Low voltage 2	V	0.01	193.9	190	276
Low voltage 1	V	0.01	243.76	240	276
High voltage 1	V	0.01	304.7	279	306
High voltage 2	V	0.01	332.4	279	335
Operating mode LV 3*	–	1	0	0	1
Operating mode LV 2*	–	1	1	0	1
Operating mode LV 1*	–	1	1	0	1

Parameter	Unit	Step size	Default	Minimum	Maximum
Operating mode HV 1*	–	1	0	0	0
Operating mode HV 2*	–	1	0	0	0
Ride through until time LV 3	s	0.1	1	0	1
Ride through until time LV 2	s	0.1	10	0	10
Ride through until time LV 1	s	0.1	20	0	20
Ride through until time HV 1	s	0.1	12	0	12
Ride through until time HV 2	s	0.1	0	0	0

*) 0 = Momentary cessation; 1 = Mandatory operation

Parameters for "FRT voltage mode"

Tab. 3

Requirement:

- The output voltage is $\geq 15\% U_{nom}$.
 - With an output voltage below $15\% U_{nom}$, the AC-DC module disconnects from the mains.
3. Select **>GRID CODE >UL1741SA FRTs**.
 4. Enter the desired values in the "Fault ride through voltage settings" area.

2.3 Low and high frequency ride through (SA10)

Switching on "FRT frequency mode"

The "FRT voltage mode" function controls the behavior of the AC-DC module in the event of frequency fluctuations on the mains grid. Dynamic frequency fluctuations should be balanced out as much as possible without necessitating separation of the AC-DC module from the mains.

The AC-DC module remains connected to the mains for a pre-set period of time and then disconnects from the mains, if necessary. The alarm message is displayed: "Grid code ride through time exceeded".

Activate "FRT frequency mode"

1. To switch on the function:
 - In the main menu, click on **>GRID CODE**.
 - Select the grid code in the selection list: "UL1741SA FRTs".
2. In the "Fault ride through mode" area under "Activate FRT frequency mode", select: "FRT frequency mode"

The function is switched on.

Enter parameters for "FRT frequency mode"

In order to support the mains frequency, 5 operating ranges are defined:

- Underfrequency: 2 ranges
- Nominal frequency ("Near Nominal"): 1 range
- Overfrequency: 2 ranges

If the mains frequency is in the nominal frequency range ("Near Nominal"), the AC-DC module behaves normally. The power specifications are not limited by the "FRT frequency mode" function.

The "FRT frequency mode" function is active both in charging and discharging mode.

If the mains frequency is in one of the underfrequency or overfrequency ranges, some entries made by the user will be ignored because the mains-supporting measures have priority.

A time period can be defined for each underfrequency and overfrequency range.

For each range, it is additionally possible to specify which mode the AC-DC module is to remain in while connected to the mains:

- "Mandatory operation"
The AC-DC module attempts to maintain the output apparent power.
- "Momentary cessation"
The AC-DC module reduces the output apparent power to 0.

In both modes, the AC-DC module attempts to maintain the power factor and phase position (inductive/capacitive). If one of the modes is active, these values cannot be changed.

All 3 phases are considered separately.

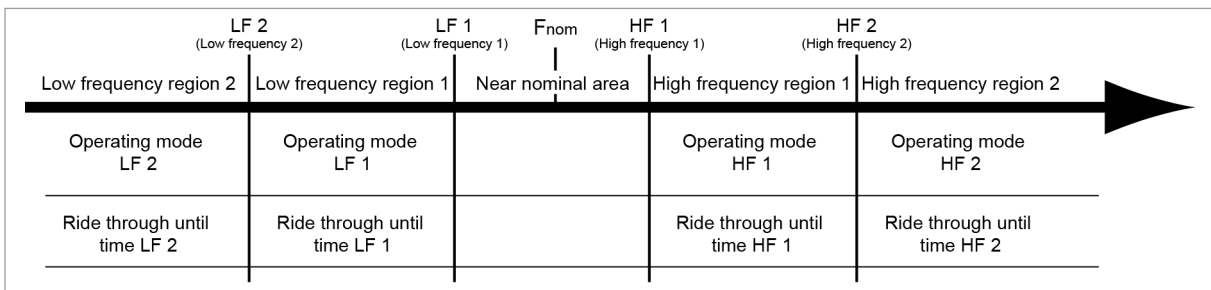

Possible frequency ranges and the corresponding parameters

Fig. 2

Parameter	Unit	Step size	Default	Minimum	Maximum
Low frequency 2	Hz	0.01	57	53	59.9
Low frequency 1	Hz	0.01	58.5	57	59.9
High frequency 1	Hz	0.01	60.5	60.1	62
High frequency 2	Hz	0.01	62	60.1	64
Operating mode LF 2*	–	1	0	0	0

Parameter	Unit	Step size	Default	Minimum	Maximum
Operating mode LF 1*	–	1	1	0	1
Operating mode HF 1*	–	1	1	0	1
Operating mode HF 2*	–	1	0	0	0
Ride through until time LF 2	s	0.1	0	0	0
Ride through until time LF 1	s	0.1	297	0	600
Ride through until time HF 1	s	0.1	297	0	600
Ride through until time HF 2	s	0.1	0	0	0

*) 0 = Momentary cessation; 1 = Mandatory operation

Parameters for "FRT frequency mode"

Tab. 4

3. Select >GRID CODE >UL1741SA FRTs .
4. Enter the desired values in the "Fault ride through voltage settings" area.

2.4 Volt-Watt mode (SA15)

Effective power as a function of voltage

The Volt-Watt mode (SA15) function is also called "P(U) mode". This function allows an effective power to be fed into or drawn from grid based on the arithmetic mean value of conductors L1, L2, L3. The provided effective power follows a defined characteristic curve here.

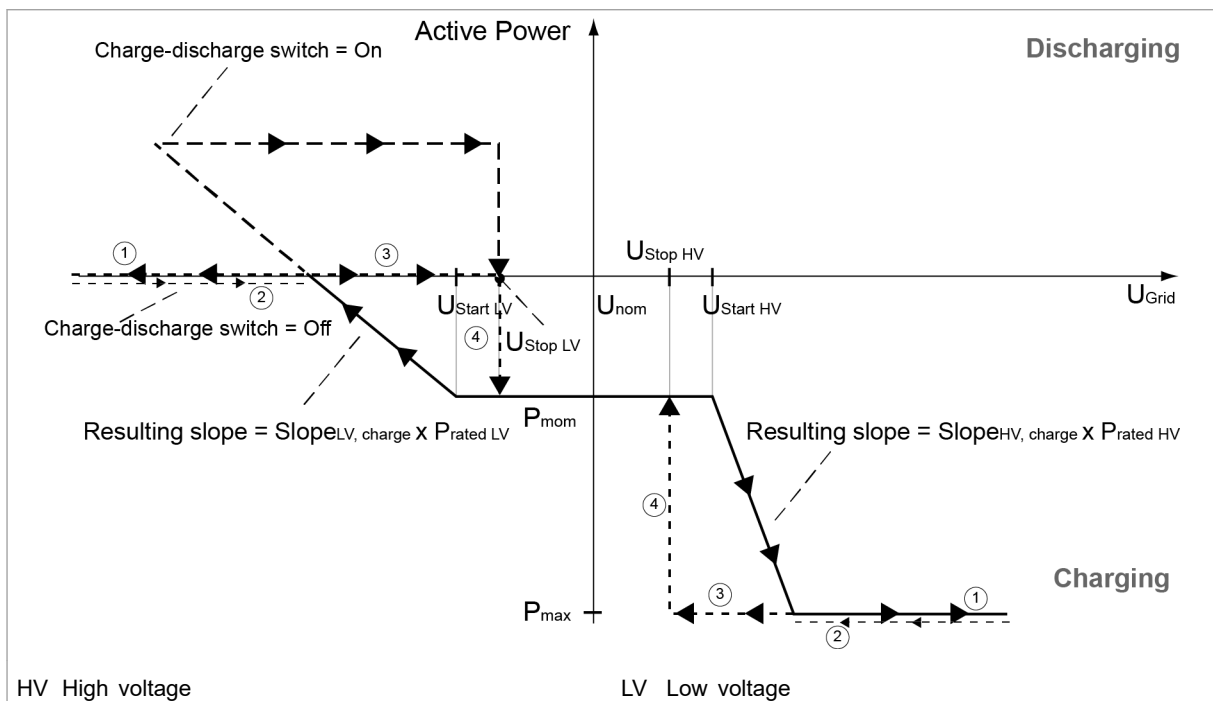

Charging: characteristic curve of function P(U)

Fig. 3

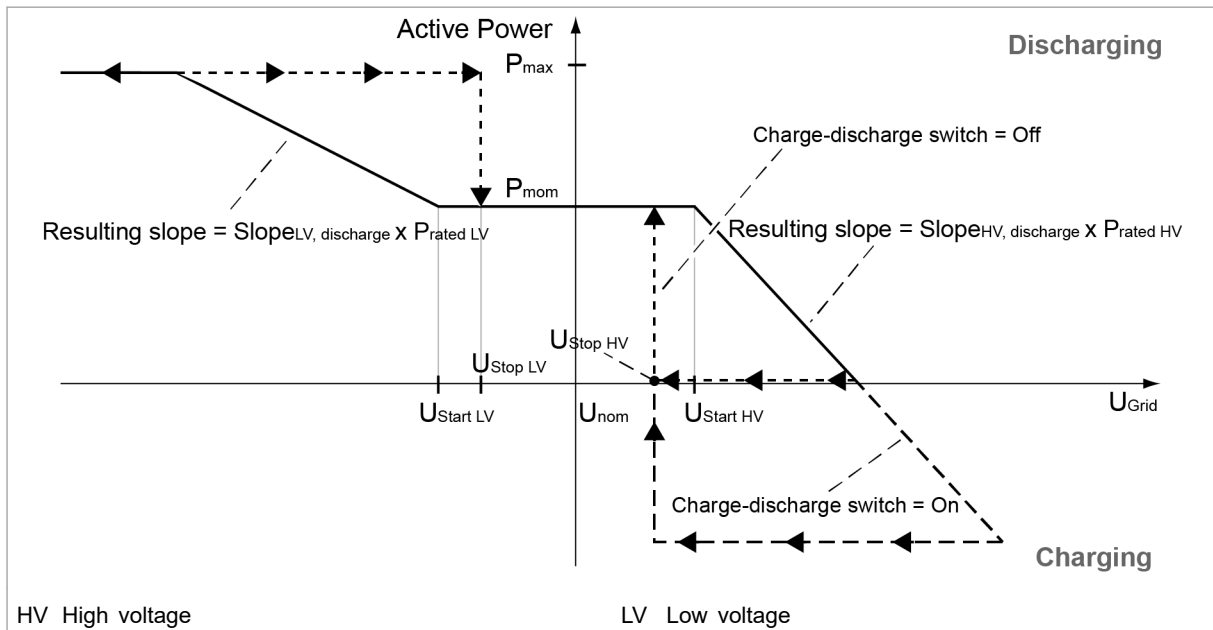

Discharging: characteristic curve of function P(U)

Fig. 4

- Function active** The function is active as soon as one of these conditions is satisfied:
- $U_{Grid} > U_{start_HV}$
 - $U_{Grid} < U_{start_LV}$

Function inactive The function is deactivated as soon as the voltage is again within the permitted voltage range and other conditions are satisfied.

The following conditions must be met in order for function P(U) to become inactive:

- $U_{stop_LV} \leq U_{Grid} \leq U_{stop_HV}$
- "Return time" for "Return to NN" has elapsed.
- After "Return time" has elapsed:
 - Effective power is again achieved before function P(U) is activated.
 - Or: "Max time" for "Return to NN" has elapsed.

Note

This function does not switch off the AC-DC module.

It is the settings in function "Fault Ride Through" or the factory settings in the device that lead to shutdown.

Switching on "P(U) mode"

- Activate "P(U) mode"**
1. To switch on the function:
 - In the main menu, click on *>GRID CODE*.
 - Select the grid code in the selection list: "UL1741SA Grid Codes"
 2. In the "Grid code mode" area under "Activate P(U) mode", select: "P(U)"

The function is switched on.

- Enter parameters for "P(U) mode"**
3. Select *>GRID CODE >UL1741SA Grid Codes*.
 4. Enter the desired values in the "P(U) mode settings" area.

Parameter	Unit	Step size	Default	Minimum	Maximum
High voltage: Voltage start	V	0.1	280	280	305
Low voltage: Voltage start	V	0.1	275	250	275
High voltage: Slope charge	% P_{rated}/V	0.1	10	0	100
High voltage: Slope discharge	% P_{rated}/V	0.1	10	10	100
Low voltage: Slope charge	% P_{rated}/V	0.1	10	0	100
Low voltage: Slope discharge	% P_{rated}/V	0.1	10	10	100
High voltage: Rated Power	–	–	1: Nominal power	0: Momentary power	1: Nominal power
Low voltage: Rated Power	–	–	1: Nominal power	0: Momentary power	1: Nominal power
High voltage: Voltage stop	V	0.1	280	278	305
Low voltage: Voltage stop	V	0.1	275	250	277
Charge-discharge switch	–	–	0: OFF	0: OFF	1: ON
"Return to NN": "Slope"	% W/V	0.01	1	1	10
"Return to NN": "Max time"	s	0.1	600	0	3600
"Return to NN": "Return to NN"	s	0.1	1	0	100

Adjustable parameters for function P(U) (SA15)

Tab. 5

Parameter	Description
Voltage start	<p>There are 2 parameters here. One for overvoltage and one for undervoltage.</p> <p>The starting voltage is the voltage at which function P(U) is activated.</p> <p>If $U_{Grid} > U_{start_HV}$ or $U_{Grid} < U_{start_LV}$, P(U) is active and the function takes control.</p>
Slopes and Rated power	<p>As soon as function P(U) is activated, characteristic curve P(U) is traversed.</p> <p>At this point in time, there is a critical grid condition and apparent power S, $\cos\phi$ power factor and the phase shift can no longer be changed.</p> <p>There are a total of 4 adjustable slopes s:</p> <ul style="list-style-type: none"> ▪ Discharging and overvoltage ▪ Discharging and undervoltage ▪ Charging and overvoltage ▪ Charging and undervoltage <p>The respective slope s is multiplied by the setting for "Rated power" to obtain the resulting slope.</p> <p>Choices for "Rated power" are:</p> <ul style="list-style-type: none"> ▪ "Nominal power" (25 kW) ▪ "Momentary power": Apparent power is again achieved before function P(U) is activated. <p>Examples</p> <p>If $s = 10\% \text{ W/V}$ and "Rated power" = "Nominal power" (25 kW) => Resulting slope = $10\% \times 25 \text{ kW/V} = 2.5 \text{ kW/V}$.</p> <p>If $s = 20\% \text{ W/V}$ and "Rated power" = "Momentary power" and the power at the start of function $P_{Mom} = 15 \text{ kW}$ => Resulting slope = $20\% \times 15 \text{ kW/V} = 3 \text{ kW/V}$.</p> <p>Note</p> <p>Function P(U) is not strictly a "traversing of the characteristic curve". In the event of overvoltage: as soon as the voltage increases, function P(U) is a traversal of the characteristic curve. If the voltage drops again, the current effective power value during voltage feedback is held constant at "Near nominal". The reduction of the effective power does not occur until in "Return to NN" mode.</p>
Charge-discharge switch	<p>Automatic switching between charging and discharging while characteristic curve P(U) is being traversed can be permitted or prohibited.</p> <p>Set switch "Charge-discharge switch" to "1: Switch possible" to permit automatic switching.</p>
Voltage stop	<p>There are 2 parameters here. One for overvoltage and one for undervoltage.</p> <p>As soon as $U_{stop_LV} < U_{Grid} < U_{stop_HV}$, function P(U) changes to Return to NN mode.</p>
Return to NN mode	<p>As soon as the grid voltage is again between U_{stop_HV} and U_{stop_LV}, "Return to NN mode" starts. The effective power is first held constant for a defined time ("Return time"). After "Return time" has elapsed, the effective power is again achieved before function P(U) is activated. "Return to NN: Slope" Function P(U) is ended as soon as the effective power is again achieved before function P(U) is activated or the set "Max time" has elapsed.</p>
Functionality	<p>To obtain the predefined effective power P, the reactive power Q is kept constant as long as possible and the apparent power S adapted. If this is no longer possible, $\cos\phi$ power factor is rotated in direction 1.</p>

Description of the parameters

Tab. 6

2.5 Frequency-Watt mode (SA14)

Effective power as a function of grid frequency

The Frequency-Watt mode (SA14) function is also called "P(f) mode".

This function allows a grid frequency that is dependent on effective power to be fed into or drawn from mains. The provided effective power follows a defined characteristic curve here.

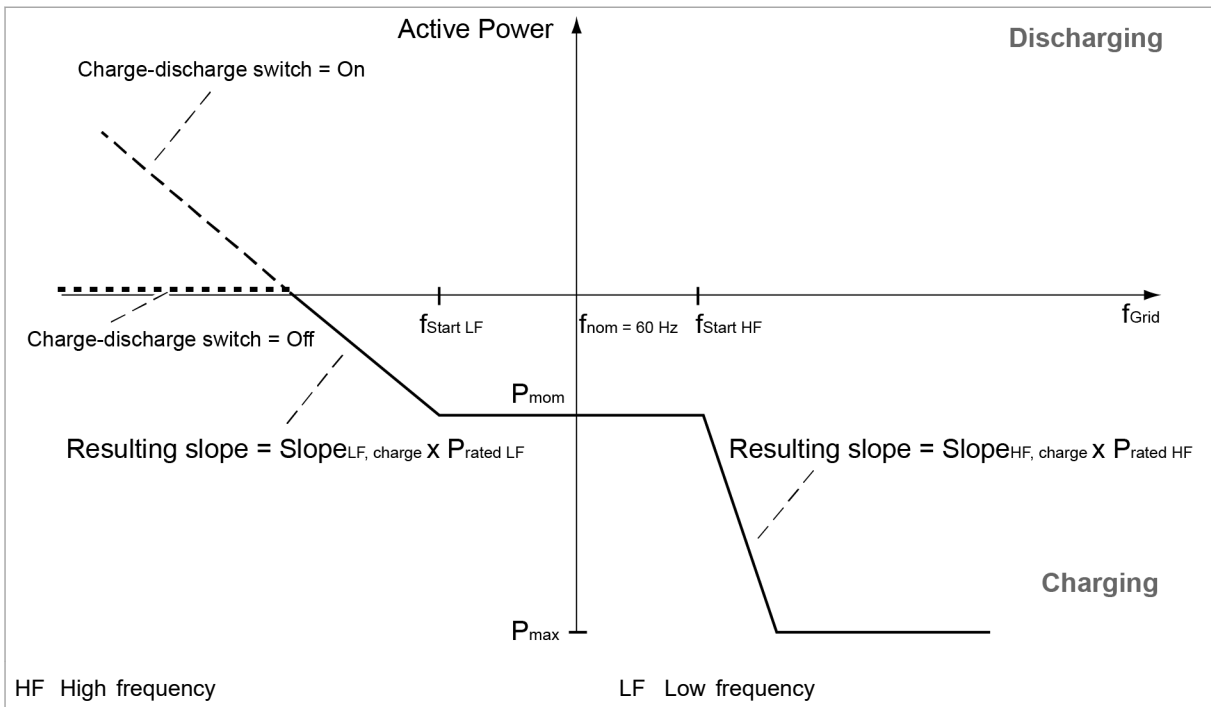

Charging: characteristic curve of function P(f)

Fig. 5

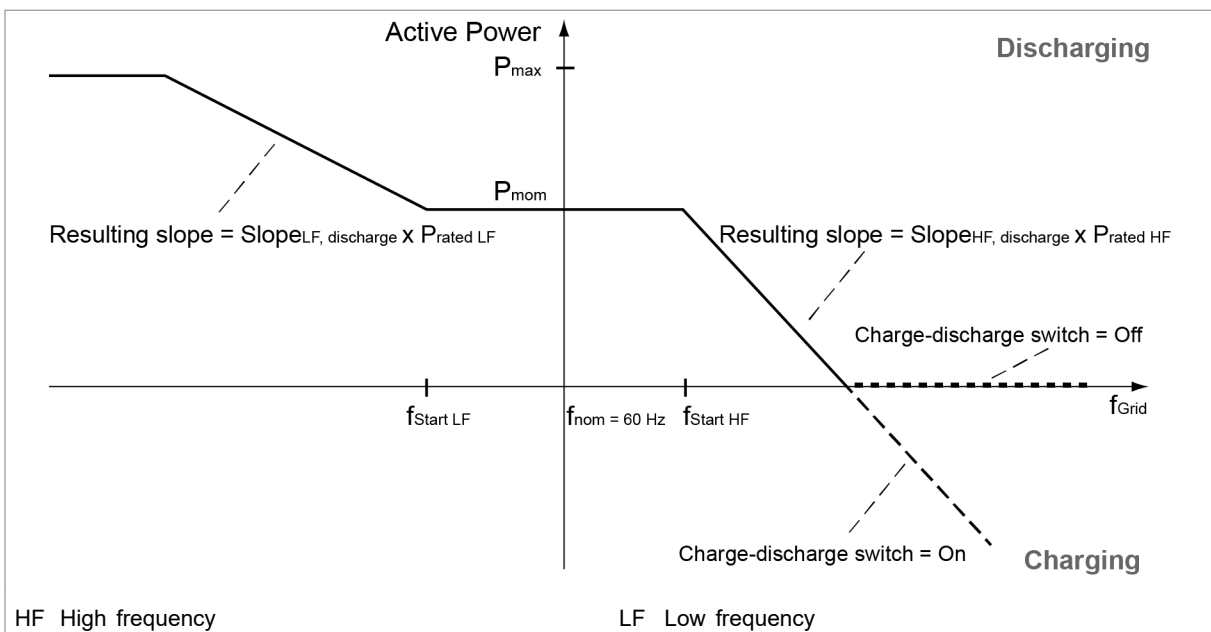

Discharging: characteristic curve of function P(f)

Fig. 6

Function active The function is active as soon as one of these conditions is satisfied:

- $f_{\text{Grid}} \geq f_{\text{start_HF}}$
- $f_{\text{Grid}} \leq f_{\text{start_LF}}$

Function inactive The function is again deactivated as soon as the frequency is again within the permitted frequency range. There is a difference here if alarm mode is also active or inactive.

- Without alarm mode: $f_{\text{start_LF}} < f_{\text{Grid}} < f_{\text{start_HF}}$
- With alarm mode, the following conditions must be met:
 - $f_{\text{start_LF}} < f_{\text{Grid}} < f_{\text{start_HF}}$
 - Time span (duration) for alarm mode has elapsed.

Note

This function does not switch off the AC-DC module.

It is the settings in function "Fault Ride Through" or the factory settings in the device that lead to shutdown.

Switching on "P(f) mode"

- Activate "P(f) mode"**
1. To switch on the function:
 - In the main menu, click on *>GRID CODE*.
 - Select the grid code in the selection list: "UL1741SA Grid Codes"
 2. In the "Grid code mode" area under "Activate P(f) mode", select: "P(f)"

The function is switched on.

- Enter parameters for "P(f) mode"**
3. Select *>GRID CODE >UL1741SA Grid Codes*.
 4. Enter the desired values in the "P(f) mode settings" area.

Parameter	Unit	Step size	Default	Minimum	Maximum
High frequency: Frequency start	Hz	0.001	60.2	60.01	64.00
Low frequency: Frequency start	Hz	0.001	59.8	56.00	59.99
High frequency: Slope charge	% P _{rated} /Hz	0.1	10	0	100
High frequency: Slope discharge	% P _{rated} /Hz	0.1	50	25	100
Low frequency: Slope charge	% P _{rated} /Hz	0.1	10	0	100
Low frequency: Slope discharge	% P _{rated} /Hz	0.1	50	25	100
High frequency: Rated Power	–	–	1: Nominal power	0: Momentary power	1: Nominal power
Low frequency: Rated Power	–	–	1: Nominal power	0: Momentary power	1: Nominal power
Charge-discharge switch	–	–	0: Off	0: Off	1: On
Alarm mode	–	–	0: Off	0: Off	1: On
Alarm mode: Slope	% W/Hz	0.01	1	1	10
Alarm mode: Duration	s	0.1	60	0	3600

Adjustable parameters for function P(f) (SA14)

Tab. 7

Parameter	Description
Frequency start	<p>There are 2 parameters here. One for overfrequency and one for underfrequency.</p> <p>The starting frequency is the frequency above which function P(f) is activated.</p> <p>If $f_{Grid} \geq f_{start_HF}$ or $f_{Grid} \leq f_{start_LF}$, P(f) is active and the function takes control.</p>
Slopes and Rated power	<p>As soon as function P(f) is activated, characteristic curve P(f) is traversed.</p> <p>At this point in time, there is a critical grid condition and apparent power S, cosφ power factor and the phase shift can no longer be changed.</p> <p>There are a total of 4 adjustable slopes:</p> <ul style="list-style-type: none"> ▪ Discharging and overfrequency ▪ Discharging and underfrequency ▪ Charging and overfrequency ▪ Charging and underfrequency <p>The respective slope s is multiplied by the setting for "Rated power" to obtain the resulting slope.</p> <p>Choices for "Rated power" are:</p> <ul style="list-style-type: none"> ▪ "Nominal power" (25 kW) ▪ "Momentary power": Apparent power is again achieved before function P(U) is activated. <p>Examples</p> <p>If s = 10% W/Hz and "Rated power" = "Nominal power" (25 kW) => Resulting slope = 10% x 25 kW/Hz = 2.5 kW/Hz.</p> <p>If s = 20% W/Hz and "Rated power" = "Momentary power" and the power at the start of function P_Mom = 15 kW => Resulting slope = 20% x 15 kW/Hz = 3 kW/Hz.</p>

Parameter	Description
Charge-discharge switch	Automatic switching between charging and discharging while characteristic curve P(f) is being traversed can be permitted or prohibited. Set switch "Charge-discharge switch" to "1: Switch possible" to permit automatic switching.
Alarm mode	If alarm mode is deactivated, function P(f) is deactivated as soon as $f_{start_LF} < f_{Grid} < f_{start_HF}$. If alarm mode is activated, then set value changes are permitted only to a limited extent for a certain length of time ("Alarm mode": "Duration"). The S set value changes with a slope of $s = Slope \times S_{max}$.
Functionality	To obtain the predefined effective power P, the reactive power Q is kept constant as long as possible and the apparent power S adapted. If this is no longer possible, $\cos\phi$ power factor is rotated in direction 1.

Description of the parameters

Tab. 8

2.6 Volt/Var mode (SA13)

Switching on "Volt/Var mode"

This function enables reactive power to be drawn from the grid or fed into the grid.

The function is active as soon as the grid voltage is outside a specified value range. This value range and other threshold values must be set in accordance with the specifications of the grid operator.

If the function is active, the user cannot change the output apparent power, power factor or phase position (inductive/capacitive).

Activate "Volt/Var mode"

- To switch on the function:
 - In the main menu, click on *>GRID CODE*.
 - Select the grid code in the selection list: "UL1741SA Grid Codes"
- In the "Grid code modes" area under "Activate Q mode", select: "Q(U)"

The function is switched on.

Enter parameters for Q(U)

- Select *>GRID CODE >UL1741SA Grid Codes*.

There are 4 value pairs which define the characteristic curve: Point1(V1;Q1 = "Max rated Q"), Point2(V2;Q2 = 0 kVAr), Point3(V3;Q3 = 0 kVAr), Point4(V4;Q4 = "Max rated Q"). That

means there are 5 values that must be defined: V1 to V4 and the maximum reactive power "Max rated Q".

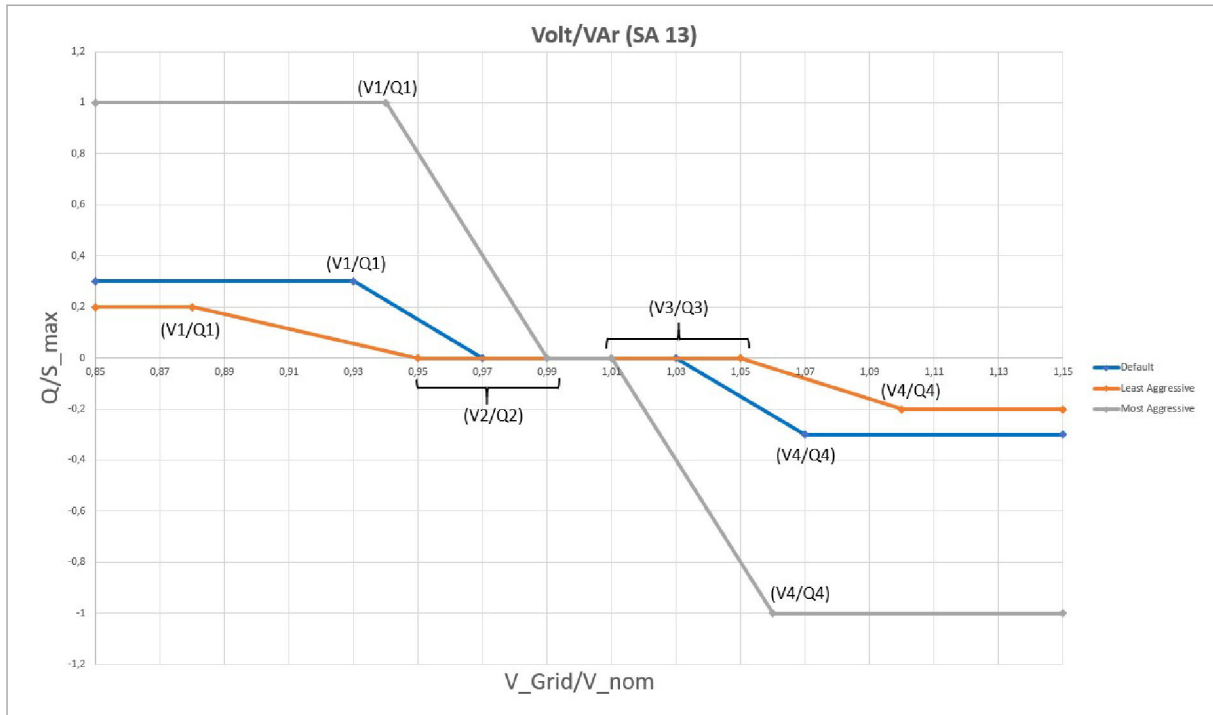

Current/reactive power characteristic curve for ranges in which reactive power compensation occurs.

Fig. 7

4. In the "Q mode settings" area, enter the desired values in "Q(U): ...".

Parameter	Default	Min	Max	Step size
Voltage 1	93%	88% (\pm 244 V)	94% (\pm 260 V)	0.1
Voltage 2	97%	95 % (\pm 260 V)	99% (\pm 274 V)	0.1
Voltage 3	103%	101% (\pm 280 V)	105% (\pm 291 V)	0.1
Voltage 4	107%	106% (\pm 291 V)	110% (\pm 305 V)	0.1
Max rated Q	30% kVAr	20% kVAr (\pm 5 kVAr)	100% kVAr (\pm 25 kVAr)	0.1

Value ranges for V1 to V4 and "Max rated Q"

Tab. 9

Between voltage threshold values V2 and V1 or V3 and V4, delivery of the reactive power value to the grid is linear to the changing mains voltage.

The slope between these voltage threshold values depends on previously defined values V1 to V4 and "Max rated Q".

2.7 Specified power factor (SA12)

Setting the Specified power factor

With this function, a constant power factor $\cos\varphi$ and a constant phase position for discharging mode can be specified.

Despite the defined power factor $\cos\varphi$ in discharging mode, switching between charging and discharging is possible during operation.

Operating state	Meaning for the power factor $\cos\varphi$	Adjusting
Discharging	The specified power factor $\cos\varphi$ is used.	(see "Entering $\cos(\Phi)$ value", pg. 25)
Charging	All values for power factor $\cos\varphi$ are still possible.	>Operation >Device control AC-DC module in the "Device control AC-DC" area, enter the value in "Power factor (CosPhi)". Note the selected reference arrow system and set the sign accordingly.
Discharging → Charging (switching)	It is possible to switch between the fixed value for the power factor $\cos\varphi$ in discharging mode to any value with the opposite sign in charging mode.	>Operation >Device control AC-DC module in the "Device control AC-DC" area, enter the value in "Power factor (CosPhi)". Note the selected reference arrow system and set the sign accordingly.
Charging → Discharging (switching)	It is possible to switch from a value for the power factor $\cos\varphi$ in charging mode to the fixed value with the opposite sign in discharging mode.	>Operation >Device control AC-DC module in the "Device control AC-DC" area, enter the opposite sign in "Power factor (CosPhi)" (value irrelevant). The system switches to discharging mode with the fixed value for the power factor $\cos\varphi$.

Changing operating states and operating states

Tab. 10

Activate "Specified power factor"

- To switch on the function:
 - In the main menu, click on >GRID CODE.
 - Select the grid code in the selection list: "UL1741SA Grid Codes"
- In the "Grid code mode" area under "Activate Q mode", select: "SPF $\cos(\Phi)$ "

The function is switched on.

Entering $\cos(\Phi)$ value

- Select >GRID CODE >UL1741SA Grid Codes.
- In the "Q mode settings" area, enter the desired value under "SPF: $\cos(\Phi)$ value".

As soon as power output has been enabled at the AC-DC module ("Activate power stage" = 1), the entered power factor is adopted and can no longer be changed for the discharge operation during operation.

2.8 Normal ramp rate and soft-start ramp rate (SA11)

Adjust Normal ramp rate and soft-start ramp rate

Activate Rampe rate mode

In discharging mode, this function can be used to move the apparent output power linearly from a set value to a new set value. The slope of the linear set value change is specified with the change speed [kVA/s].

Requirement:

- Discharging mode: $\cos\phi \geq 0$.

1. To switch on the function:
 - In the main menu, click on *>GRID CODE*.
 - Select the grid code in the selection list: "UL1741SA Grid Codes"
2. In the "Grid code mode" area under "Activate ramp rate mode", select: "Ramp rate"

The function is switched on.

Enter parameters for Rampe rate mode

3. Select *>GRID CODE >UL1741SA Grid Codes*.
4. In the "Ramp rate mode settings" area, enter the desired value under "Ramp rate: slope".
 - Minimum slope: 0.1 kVA/s
 - Maximum slope: 833 kVA/s

The "Ramp rate" is active for all set value changes in discharging mode and is the same for power increase and power decrease.

2.9 Anti-islanding protection (SA8)

Switching on Anti-islanding protection

If inadvertent isolated operation is detected, the AC-DC module is switched off within 2 s.

This function is always switched on if "grid-tied system" is selected. The function is active in the background no matter whether other grid code functions are activated.

1. Select *>Operation >AC-DC module settings*.

2. Under "Grid voltage", enter the grid voltage and grid frequency as well as the operating mode:
 - 400 V / 50 Hz, 480 V / 60 Hz, ...
 - Grid-tied or isolated operation

2.10 Switch-on criteria "Switch on criteria"

Setting switch-on/switch-off conditions

The grid voltage and grid frequency must move within a defined range for a certain period of time; only then can the AC-DC module be connected. If the conditions are not satisfied, a corresponding alarm message is displayed ("Grid does not match grid code requirements.").

Activate "Switch on criteria"

1. To switch on the function:
 - In the main menu, click on *>GRID CODE*.
 - Select the grid code in the selection list: "UL1741SA FRTs".
2. In the "Grid code modes" area under "Switch on criteria", select: "Active".

The function is switched on.

Enter parameters for "Switch on criteria"

3. Select *>GRID CODE >UL1741SA Grid Codes*.
4. Enter the desired values in the "Switch on settings" area.
 - Under "Voltage min" and "Voltage max": Enter the minimum and maximum value for the grid voltage.
 - Under "Frequency min" and "Frequency max": Enter the minimum and maximum value for the grid frequency.
 - Under "Time": Enter the time period.

Parameter	Unit	Step size	Default value	Area
Voltage, min.	V	0.01	263.15	250– 276
Voltage, max.	V	0.01	290.85	278– 300
Frequency, min.	Hz	0.01	59.3	58 – 59,9
Frequency, max.	Hz	0.01	60.5	60,1 – 61
Time	s	0.1	10	0 – 300

Possible parameter values for "Switch on criteria"

Tab. 11

3. ARN4105

3.1 Hierarchy of the grid code functions

If several grid code functions are active at the same time, the function with the highest hierarchy level takes control.

From the functions of the Q modes, only one function can be selected in advance. Thus, only the selected function of the Q modes can intervene.

Hierarchy	Name of the function		Meaning of the function
0	Anti-islanding		Anti-islanding protection
1	RT voltage		Dynamic grid support
2	Bypass		Reduction of the output power to 0 kVA
3	P(f)		Effective power matching in the event of overfrequency and underfrequency
4	Q modes	Q(U)	Reactive-power voltage curve Q(U)
4	Static voltage stability/provision of reactive power	Constant cosPhi	Fixed power factor $\cos\varphi$
4		cosPhi(P)	Power-factor/effective-power curve $\cos\varphi$ (P)

Hierarchy of the grid code functions

Tab. 12

The individual functions are described separately in the further sections.

(See also "VDE-AR-N 4105.2018-11 – Power generating plants on the low voltage network".)

Additional functions

Name of the function	Meaning of the function
Step response for Q	Step response behavior for reactive power Q These additional functions change the behavior of the Q(U), Constant cos(Phi), cosPhi(P) and RT voltage functions.
Switch on criteria	Switch-on criteria
Startup ramp	Startup ramp
Active power limiting	Power limiter

Additional functions

Tab. 13

3.2 Anti-islanding protection

Switching on Anti-islanding protection

If inadvertent isolated operation is detected, the AC-DC module is switched off within 2 s.

This function is always switched on if "grid-tied system" is selected. The function is active in the background no matter whether other grid code functions are activated.

1. Select *>Operation >AC-DC module settings*.
2. Under "Grid voltage", enter the grid voltage and grid frequency as well as the operating mode:
 - 400 V / 50 Hz, 480 V / 60 Hz, ...
 - Grid-tied or isolated operation

3.3 Dynamic grid support "RT voltage mode"

Function description "RT voltage mode"

The "RT voltage mode" function controls the behavior of the AC-DC module in the event of undervoltage and overvoltage on the mains grid.

Behavior in the event of extreme grid fluctuations:

- The AC-DC module remains connected to the grid. Not until the grid fluctuations exceed the defined limits for one grid period is the device disconnected from the grid after a delay time. (see "Fig. 8", pg. 30)
- The AC-DC module reduces its output apparent power to $S = 0$ kVA.

As long as the grid fluctuations are within the limit characteristic curves, the AC-DC module remains connected to the grid.

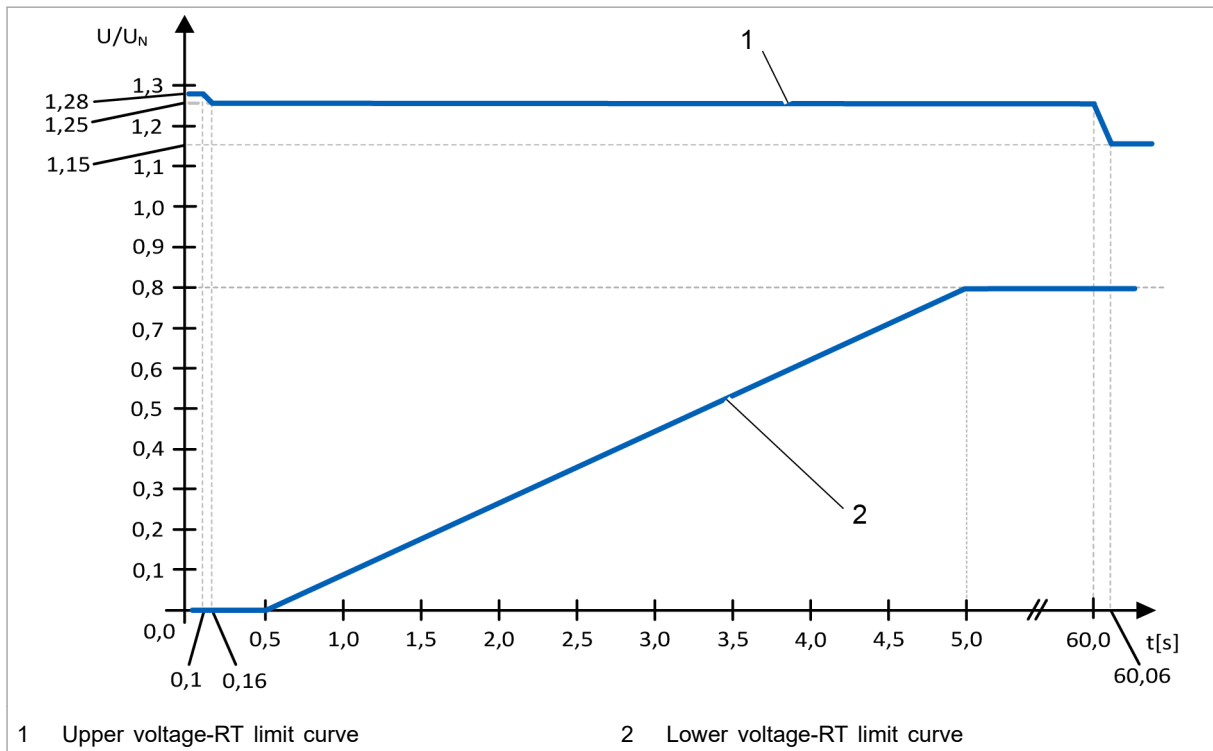

Voltage-RT limit curve of the AC-DC module

Fig. 8

Interpolation point no.	Time [s]	U [% Unom]
1	0.0	128
2	0.1	128
3	0.16	125
4	60.0	125
5	60.06	115
6	∞	115

Upper voltage RT limit curve: interpolation points for the implemented limit curve

Tab. 14

Interpolation point no.	Time [s]	U [% Unom]
1	0.0	0
2	0.5	0
3	5.0	80
4	∞	80

Lower voltage RT limit curve: interpolation points for the implemented limit curve

Tab. 15

If the grid voltage is less than 85% of U_{nom} or greater than 115% of U_{nom} , the output apparent power is reduced to 0 kVA as quickly as possible (max. 60 ms).

This is a critical grid condition and the inverter is in grid-supporting operation: apparent power S , power factor $\cos\phi$ and the phase position can no longer be changed. All entries for these

quantities are ignored as long as grid-supporting operation is active.

As soon as the grid fault has ended, the AC-DC module attempts to restore the pre-fault value. This occurs either immediately or by means of a PT1 behavior (see ["Switching on Step response for Q"](#), pg. 46).

Grid fault is ended if one of these criteria is satisfied:

- Outer conductor - neutral conductor voltages of the device are again within the range from $-15\% U_{nom}$ to $+10\% U_{nom}$.
 - The smallest of the 3 outer conductor - neutral conductor voltages is checked against the undervoltage limit curve.
 - The largest of the 3 outer conductor - neutral conductor voltages is checked against the overvoltage limit curve.
- 5 s have passed since the start of the grid fault.

The "RT voltage mode" function is active during charging and discharging mode.

Switching on "RT voltage mode"

1. To switch on the function:
 - In the main menu, click on *>Configuration*.
 - Select the grid code in the selection list: "ARN4105".
2. In the "Grid code modes" area under "RT voltage mode", select: "Active".

The function is switched on.

In addition to this function, a step response can be set. (see ["Switching on Step response for Q"](#), pg. 46)

Parameterization "RT voltage mode"

No parameters are adjustable.

More information about "RT voltage mode"

Disconnection from the grid if the voltage drops below the minimum voltage

There is an additional limitation for the overvoltage: The battery voltage or DC link voltage present at the time of the overvoltage. The necessary battery voltage or DC link voltage is depicted as a function of the voltage increase.

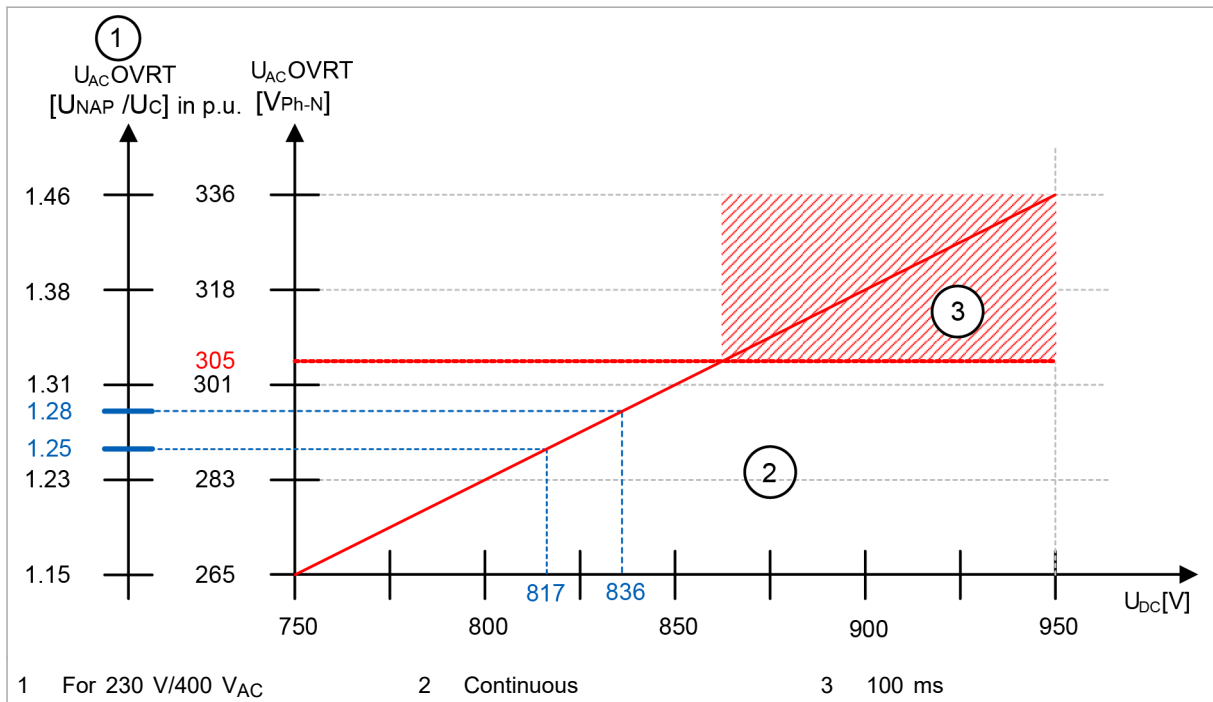

Minimum requirements for the overvoltage capability of the device

Fig. 9

If the battery voltage or DC link voltage is below the required minimum voltage during a grid-side overvoltage, there is a risk that uncontrolled current could flow from the grid towards the battery. To protect the AC-DC module and the battery, the AC-DC module disconnects itself from the grid.

To guarantee the overvoltage capability, the minimum DC link voltage must be adjusted according to the selected AC grid voltage:

- Overvoltage capability of 125%: U_{dc_min} = 817 V.
(Minimum requirement according to standard)
- Overvoltage capability of 128%: U_{dc_min} = 836 V.
(maximum overvoltage capability of the TruConvert AC 3025)

Note

If the battery is directly connected to the DC link, ensure the following:
The OCV battery voltage must be at least as large as the minimum voltage U_{dc_min}.

3.4 Bypass

Description of functions "Bypass"

The "Bypass" function immediately sets the output power to $S = 0$ kVA as soon as it is active.

Because the "Bypass" function has a higher priority than most grid codes, the power of the device can be set to $S = 0$ kVA even if a grid code is active.

Switching on "Bypass"

1. To switch on the function:
 - In the main menu, click on *>Operation >AC-DC module settings*.
2. In the "Grid code bypass function" area, select "1: Set S to 0 W".

The function is switched on.

The function can also be switched on and off during running operation.

Parameterization "Bypass"

All adjustable parameters are listed in the following table.

Parameter	Description	Unit	Adjustment range		Factory settings	Step size
			Minimum	Maximum		
Grid code bypass function (Modbus ID: 4280)	Activate/deactivate the bypass function. If active, the output power is set to $S = 0$ kVA.	–	0: Inactive	1: Set S to 0 W	0: Inactive	1

Adjustable parameters for function "Bypass"

Tab. 16

3.5 Effective power matching in the event of overfrequency and underfrequency "P(f) mode"

Function description "P(f) mode"

The "P(f) mode" function controls the effective power matching in the event of overfrequency and underfrequency.

This function allows a grid frequency that is dependent on effective power to be fed into or drawn from mains. The provided effective power follows a defined characteristic curve here.

Example characteristic curve for P(f), here with $s_{\text{Overf}} = 5\%$, $s_{\text{Underf}} = 2\%$, $P_{\text{mom}} = 100\% \times P_{\text{b inst}}$:

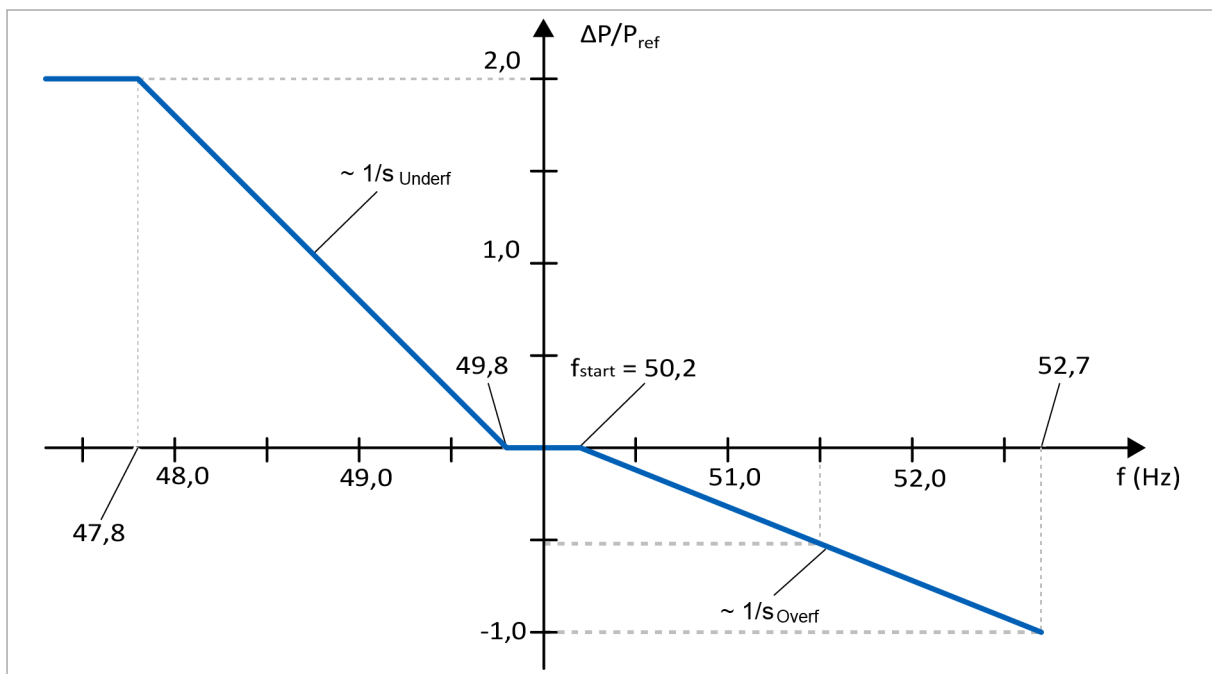

Characteristic curve of function P(f)

Fig. 10

The P(f) function actively intervenes

In normal operation, the P(f) function has no effect on the behavior of the inverter. It actively intervenes as soon as the defined tolerance band is exited. At this point in time, there is a critical grid condition and apparent power S , $\cos\phi$ power factor and the phase shift can no longer be changed. The function is active and orients itself according to the P(f) characteristic curve.

Tolerance band:

$$49.8 \text{ Hz} \leq f_{\text{Grid}} \leq \text{Overf: frequency start}$$

Return to normal operation

If the grid frequency is again within the defined tolerance band, the output power has again reached its pre-fault value for appa-

rent power S and power factor $\cos\varphi$. There is, however, still a critical grid condition. For a duration of 10 min, all set value changes of the effective power are limited by a fixed gradient. The value of the gradient is $10\% P_{\text{binst}}/\text{min}$. In the device settings, the gradient is given so that the apparent power is limited and the preset value of the power factor $\cos\varphi$ remains constant. Thus, the change in effective power occurs somewhat more slowly than the set gradient. The change in effective power can, however, never be faster than $10\% P_{\text{binst}}/\text{min}$.

The critical grid condition ends after the grid frequency has been within the permissible tolerance band for a full 10 min. All restrictions associated with this condition are thereby suspended.

Requirements on the reactive power

The effective power P is specified by the $P(f)$ characteristic curve. No requirements are placed on the reactive power, however.

To keep from further straining the grid during a critical grid condition, the reactive power is held as constant as possible. To do this, the current reactive power is stored upon exiting the tolerance band and this value maintained.

If the maximum apparent power is not sufficient for satisfying the effective power requirement, the provided reactive power is reduced to the benefit of the effective power.

Switching on "P(f) mode"

1. To switch on the function:
 - In the main menu, click on *>Configuration*.
 - Select the grid code in the selection list: "ARN4105".
2. In the "Grid code modes" area under "P(f) mode", select: "P(f)"

The function is switched on.

Parameterization "P(f) mode"

All adjustable parameters are listed in the following table.

Parameter	Description	Unit	Adjustment range		Factory settings	Step size
			Minimum	Maximum		
Overf: frequency start f_{start}	Overfrequency limit	Hz	50.2	50.5	50.2	0.1
Overf: s charge s	Droop of the frequency-dependent supply of effective power in the case of overfrequency during charging mode	%	2.0	12.0	2.0	0.1
Underf: s charge s	Droop of the frequency-dependent supply of effective power in the case of underfrequency during charging mode	%	2.0	12.0	2.0	0.1
Overf: s discharge s	Droop of the frequency-dependent supply of effective power in the case of overfrequency during discharging mode	%	2.0	12.0	2.0	0.1
Underf: s discharge s	Droop of the frequency-dependent supply of effective power in the case of underfrequency during discharging mode	%	2.0	12.0	2.0	0.1
Charge_discharge_switch	If activated, it is possible to switch from charging mode to discharging mode and vice versa. If deactivated, then stop at S = 0 kVA.	–	0: No switch possible	1: Switch possible	0: No switch possible	1

Abbreviations: s = droop; f = frequency; S = apparent power

Adjustable parameters for function P(f)

Tab. 17

Parameter	Description
Overf: frequency start f _{start}	<p>This is the upper limit of the frequency tolerance band. The upper limit is adjustable within the specified value range.</p> <p>The lower limit is fixed: 49.8 Hz.</p> <p>If the grid frequency exits the tolerance band, the P(f) function takes control and adjusts the output effective power according to the set P(f) curve.</p> <p>If the upper or lower limit is reached, the value of the momentary effective power P_{mom} is stored. Here, the value P_{mom} is the average value of all 3 phases. This value P_{mom} is adjusted by the amount ΔP and thereby forms the adapted power P_{adapted}.</p> $P_{adapted} = P_{mom} - \Delta P$
Overf: s charge Overf: s discharge s	<p>These 2 droops are defined for the case of an overfrequency. Which droop is used is dependent on whether the inverter is in charging mode or discharging mode at the time the frequency is exceeded.</p> <p>The droop is adjustable within the specified value range. It corresponds to a power ramp of:</p> <ul style="list-style-type: none"> ▪ At s = 2% ⇒ 100% P_{ref} per hertz ▪ At s = 12% ⇒ 16.67% P_{ref} per hertz <p>P_{ref} is the reference value for the droop.</p> <p>In the event of overfrequency: P_{ref} = P_{mom}.</p>
Underf: s charge Underf: s discharge s	<p>These 2 droops are defined for the case of an underfrequency. Which droop is used is dependent on whether the inverter is in charging mode or discharging mode at the time the frequency is exceeded.</p> <p>The droop is adjustable within the specified value range. It corresponds to a power ramp of:</p> <ul style="list-style-type: none"> ▪ At s = 2% ⇒ 100% P_{ref_down} per hertz ▪ At s = 12% ⇒ 16.67% P_{ref_down} per hertz <p>P_{ref} is the reference value for the droop.</p> <p>In the event of underfrequency: P_{ref} = P_{b_inst}. P_{b_inst} is the installed power.</p>
Charge-discharge switch	<p>Automatic switching between charging and discharging while characteristic curve P(f) is being traversed can be permitted or prohibited.</p> <ul style="list-style-type: none"> ▪ 0: No switch possible At the time of switching, the output power at P = 0 kW is fixed. ▪ 1: Switch possible A change from producer to load and vice versa is permitted.

Description of the parameters

Tab. 18

Enter parameters for "P(f) mode"

1. Select >Configuration >ARN4105.
2. In the "P(f) mode settings" area enter the desired values.

More information about "P(f) mode"

Calculation of the adapted power

In the event of overfrequency, the power matching ΔP is calculated (abbreviations: s = droop; f = frequency):

$$\Delta P = \frac{f_{Grid} - f_{start}}{f_n} * \frac{1}{s} * P_{ref}$$

Fig. 11

In the event of underfrequency, the power matching ΔP is calculated:

$$\Delta P = \frac{f_{Grid} - 49,8 \text{ Hz}}{f_n} * \frac{1}{s} * P_{ref}$$

Fig. 12

The adapted power is then calculated:

$$P_{adapted} = P_{mom} - \Delta P$$

Fig. 13

Example

For better understanding, an example is given for overfrequency with the following parameters:

Description	Symbol	Value
Nominal frequency	f_n	50.00 Hz
Upper start frequency	f_{start}	50.20 Hz
Momentary grid frequency	f_{Grid}	51.40 Hz
Droop for overfrequency	$s = s_{discharge}$	2%
Stored value of the effective power upon reaching the upper starting frequency	$P_{ref} = P_{mom}$	80% of $P_{b \text{ inst}}$
Charge-discharge switch	–	True

Tab. 19

Reference power equal to momentary power ($P_{ref} = P_{mom}$) yields the following power matching ΔP :

$$\Delta P = \frac{51.40 - 50.20}{50} * \frac{1}{2 \%} * 0.8 * P_{b_{inst}} = 0,96 * P_{b_{inst}}$$

Fig. 14

And, thus, the following power:

$$P_{adapted} = 0.80 * P_{b_{inst}} - 0.96 * P_{b_{inst}} = -0.16 * P_{b_{inst}}$$

Fig. 15

For the given example, the power of the AC-DC module is adapted from 80% supply to 16% reference.

Upon return to the defined tolerance band and until the critical grid condition has ended, power matching occurs according to the currently measured frequency f_{Grid} (traversal of the characteristic curve).

Droops can only take positive values (grid-supporting feedback). In the event of overfrequency, the supply power is reduced or the draw from the grid increased. In the event of underfrequency, the supply power is increased or the draw from the grid reduced.

3.6 Static voltage stability/provision of reactive power "Q modes"

To aid the static grid support through reactive power, one of the following processes can be selected:

- Reactive power as a function of the grid voltage: "Q(U)"
- Fixed power factor $\cos\varphi$: "Constant cosPhi"
- Power factor as a function of effective power: "CosPhi(P)"

Reactive power as a function of the grid voltage: "Q(U)"

Function description "Q(U)"

Function "Q(U)" controls the provision of reactive power as a function of voltage.

This function allows a grid voltage that is dependent on reactive power to be fed into or drawn from grid. The provided reactive power follows a defined characteristic curve here.

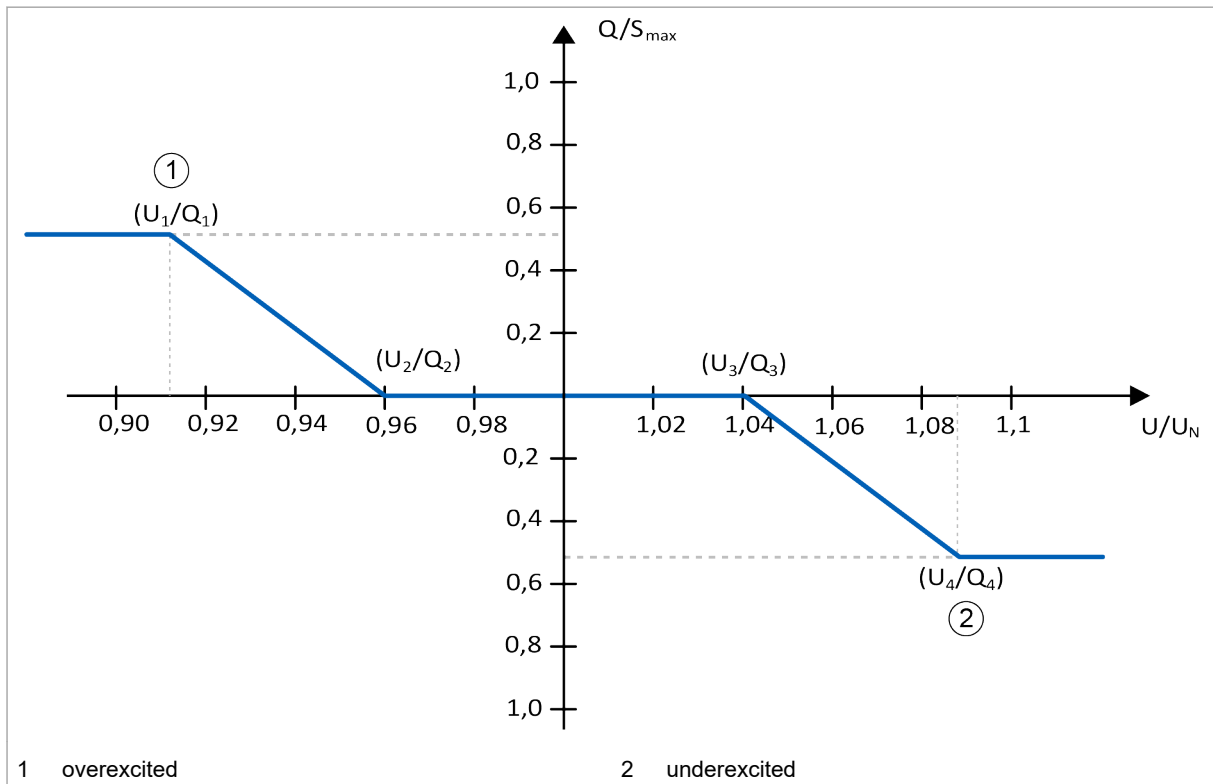

Fig. 16

Interpolation point no.	Voltage [U/U _N]	Reactive power [Q/S _{max}]
1	Voltage 1 (U ₁)	Q ₁
2	Voltage 2 (U ₂)	Q ₂ = 0.0
3	Voltage 3 (U ₃)	Q ₃ = 0.0
4	Voltage 4 (U ₄)	Q ₄ = Q ₁

Interpolation points for the implemented characteristic curve Tab. 20

Within which value ranges the individual interpolation points lie is defined for each parameter. (see "Parameterization Q(U)", pg. 41)

In the AC-DC module, the power factor $\cos\phi$ and the phase position can be specified for controlling the apparent power S.

With switched-on Q(U) function, the input of the set value for the apparent power ("Set value AC") is generally interpreted as effective power P.

- In normal operation, $\cos\phi = 1$ is set.
- In the event of fault, $\cos\phi$ is determined from the characteristic curve. The actually delivered/consumed apparent power is then determined from the set value specification ($\triangleq P$) and $\cos\phi$.

By means of the Q(U) characteristic curve, the values of the power factor $\cos\varphi$ and the phase position are uniquely determined from the set value specification ($\triangleq P$) and the grid voltage. For this reason, if the function is actively intervening, the entered parameters of the power factor $\cos\varphi$ and of the phase position are ignored.

The power factor $\cos\varphi$ determined from the characteristic curve is calculated from the entered set value and the specified reactive power (characteristic curve).

$$\cos\varphi = \sqrt{1 - \frac{Q^2}{P^2 + Q^2}}$$

Fig. 17

Switching on "Q(U)"

1. To switch on the function:
 - In the main menu, click on *>Configuration*.
 - Select the grid code in the selection list: "ARN4105".
2. In the "Grid code modes" area under "Activate Q mode", select: "Q(U)".

The function is switched on.

Parameterization "Q(U)"

All adjustable parameters are listed in the following table.

Parameter	Description	Unit	Adjustment range		Factory settings	Step size
			Mini- mum	Maxi- mum		
Q(U): voltage 1* U1	1st voltage interpolation point	p.u. of V_{nom}	0.88	0.95	0.93	0.01
Q(U): voltage 2* U2	2nd voltage interpolation point	p.u. of V_{nom}	0.95	0.99	0.97	0.01
Q(U): voltage 3* U3	3rd voltage interpolation point	p.u. of V_{nom}	1.01	1.05	1.03	0.01
Q(U): voltage 4* U4	4th voltage interpolation point	p.u. of V_{nom}	1.05	1.10	1.07	0.01

Parameter	Description	Unit	Adjustment range		Factory settings	Step size
			Minimum	Maximum		
Q(U): Q1 and Q4	Reactive power at the 1st and 4th voltage interpolation point	p.u. of S_{max}	0.0	1.0	0.436	0.001
*) $U_{1-4} = x \% U_{nom}$, $U_{nom} = 231 V$ Abbreviations: p.u. = per unit						

Adjustable parameters for function Q(U)

Tab. 21

Enter parameters for Q(U)

1. Select >Configuration >ARN4105.
2. In the "Q mode settings" area, enter the desired values in "Q(U): ...".

More information about "Q(U)"

- In the event of overvoltage or undervoltage it may occur that the set apparent power is less than the required reactive power (characteristic curve). In this case, the apparent power is automatically increased accordingly.
- The function only applies in discharging mode. In charging mode, all parameters are freely selectable.
- In addition, a PT1 behavior of the output reactive power can be activated. (see ["Switching on Step response for Q"](#), pg. 46)

Fixed power factor "Constant cosPhi"

Function description "Constant cosPhi"

With this function, a constant power factor $\cos\varphi$ and a constant phase position for discharging mode can be specified. By means of this constant power factor, it is ensured that some reactive power is always output to the grid.

In the AC-DC module, the power factor $\cos\varphi$ and the phase position can be specified for controlling the apparent power S. By selecting the "Constant cosPhi" function, the values of $\cos\varphi$ and the phase position are, for a given apparent power, uniquely determined by the grid code settings. For this reason, if the function is actively intervening, the entered parameters of the power factor $\cos\varphi$ and of the phase position are ignored. The set values are used instead.

Switching on "Constant cosPhi"

1. To switch on the function:
 - In the main menu, click on *>Configuration*.
 - Select the grid code in the selection list: "ARN4105".
2. In the "Grid code modes" area under "Activate Q mode", select: "Constant cos(Phi)"

The function is switched on.

Parameterization "Constant cosPhi"

All adjustable parameters are listed in the following table.

Parameter	Description	Unit	Adjustment range		Factory settings	Step size
			Minimum	Maximum		
Constant cosPhi: cosPhi	Constant power factor in discharging mode	–	0.0	1.0	0.9	0.01
Constant cosPhi: phase position	Constant phase position in discharging mode	–	0: capacitive	1: inductive	0: capacitive	–

Adjustable parameters for function Constant cosPhi

Tab. 22

Enter parameters for "Constant cosPhi"

1. Select *>Configuration >ARN4105*.
2. In the "Q mode settings" area, enter the desired values in "Constant cosPhi".

More information about "Constant cosPhi"

- The function only applies in discharging mode. In charging mode, all parameters are freely selectable.
- In addition, a PT1 behavior of the output reactive power can be activated. (see ["Switching on Step response for Q"](#), pg. 46)

Power factor as a function of effective power "cosPhi(P)"

Function description "cosPhi(P)"

Function "cosPhi(P)" controls the provision of reactive power by means of a changed power factor $\cos\varphi$ as a function of the set effective power. The function can be used to output a specified reactive power to the grid as a function of the set effective power. This is implemented as the cosPhi(S) characteristic curve.

In the AC-DC module, the power factor $\cos\varphi$ and the phase position can be specified for controlling the apparent power S. By selecting the "cosPhi(P)" function, the values of $\cos\varphi$ and the phase position are uniquely determined for a given apparent power. For this reason, if the function is actively intervening, the entered parameters of the power factor $\cos\varphi$ and of the phase position are ignored. Instead, the values of the cosPhi(S) characteristic curve are used.

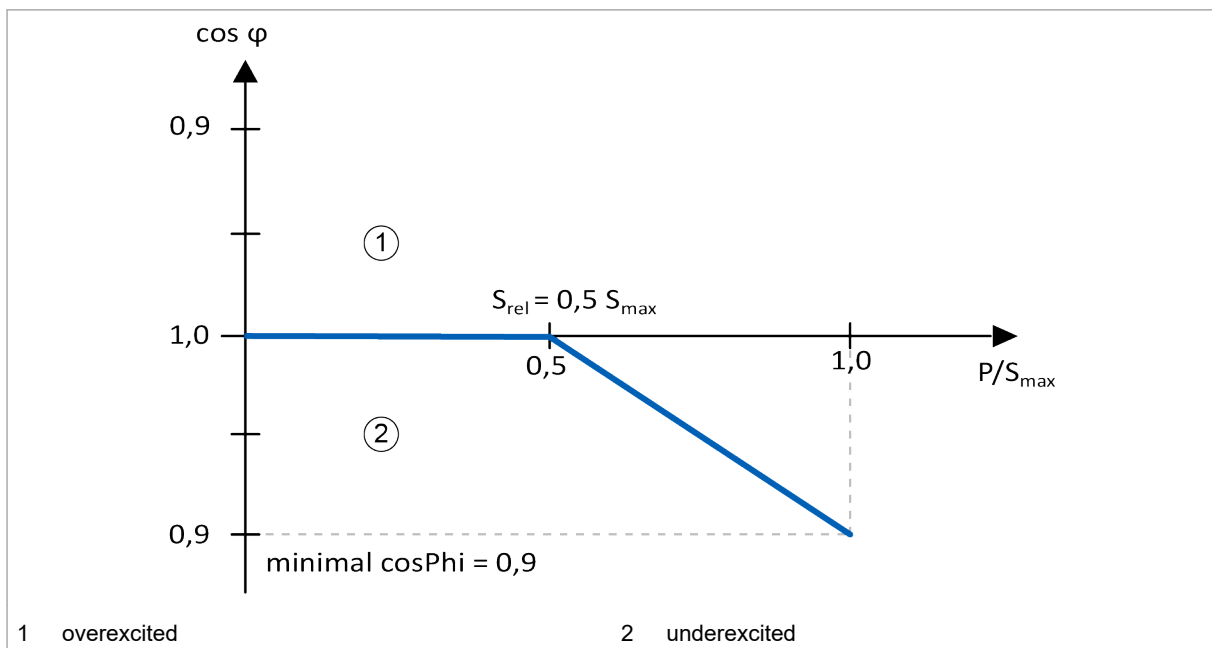

Fig. 18

Switching on "cosPhi(P)"

1. To switch on the function:
 - In the main menu, click on *>Configuration*.
 - Select the grid code in the selection list: "ARN4105".

- In the "Grid code modes" area under "Activate Q mode", select: "cosPhi(P)"

The function is switched on.

Parameterization "cosPhi(P)"

All adjustable parameters are listed in the following table.

Parameter	Description	Unit	Adjustment range		Factory settings	Step size
			Minimum	Maximum		
CosPhi(P): Srel	Start of the provision of reactive power	p.u. of S_{max}	0	1	0.5	0.01
CosPhi(P): minimal cosPhi	Minimal cosPhi at maximum power	—	0	1	0.9	0.01

Abbreviations: p.u. = per unit

Adjustable parameters for function "cosPhi(P)"

Tab. 23

Parameter	Description
CosPhi(P): Srel CosPhi(P): minimal cosPhi	For all set values of $S/S_{max} < S_{rel}$, a fixed power factor of $\cos\phi = 1$ is assumed. If the set value of S increases further, it follows the characteristic curve given above until it reaches its minimum power factor "minimal cosPhi".

Description of the parameters

Tab. 24

Enter parameters for "cosPhi(P)"

- Select >Configuration >ARN4105.
- In the "Q mode settings" area, enter the desired values in "cosPhi(P)".

More information about "cosPhi(P)"

- The function only applies in discharging mode. In charging mode, all parameters are freely selectable.
- In addition, a PT1 behavior of the output reactive power can be activated. (see "Switching on Step response for Q", pg. 46)

3.7 Step response "Step response for Q"

Function description "Step response for Q"

For changes of the reactive power, a step response can be set. This is possible with the three Q-mode functions "Q(U)", "Constant cos(Phi)" and "cosPhi(P)" as well as with the "RT voltage mode" function.

The step response defines the period in which the new value is reached. This allows either an abrupt or a more gradual change to be set.

The time constant τ determines the speed of the change here. After 3 τ , approximately 95% of the set value is reached.

$$Q(t) = Q_{set} * \left(1 - e^{-\frac{t}{\tau}}\right)$$

Fig. 19

Switching on "Step response for Q"

1. To switch on the function:
 - In the main menu, click on >Configuration.
 - Select the grid code in the selection list: "ARN4105".
2. In the "Grid code modes" area under "Activate step response for Q", select: "PT1 of Q".

The function is switched on.

Parameterization "Step response for Q"

All adjustable parameters are listed in the following table.

Parameter	Description	Unit	Adjustment range		Factory settings	Step size
			Minimum	Maximum		
PT1 of Q: tau	τ is the time constant of the step response.	s	1.0	30.0	3.0	0.1

Adjustable parameters for function "Step response for Q"

Tab. 25

Switching on "Switch on criteria"

1. To switch on the function:
 - In the main menu, click on *>Configuration*.
 - Select the grid code in the selection list: "ARN4105".
2. In the "Grid code modes" area under "Switch on criteria", select: "Active".

The function is switched on.

Parameterization "Switch on criteria"

All adjustable parameters are listed in the following table.

Parameter	Description	Unit	Adjustment range		Factory settings	Step size
			Minimum	Maximum		
Voltage min	Minimum value for the grid voltage	p.u. of V_{nom}	0.80	0.99	0.85	0.01
Voltage max	Maximum value for the grid voltage	p.u. of V_{nom}	1.01	1.15	1.10	0.01
Frequency min	Minimum value for the grid frequency	Hz	44.0	49.9	47.5	0.1
Frequency max	Maximum value for the grid frequency	Hz	50.1	56.0	50.1	0.1
Time	Time span for the switch-on check	s	0.1	300.0	60.0	0.1

Possible parameter values for "Switch on criteria"

Tab. 26

Enter parameters for "Switch on criteria"

1. Select *>Configuration >ARN4105*.
2. Enter the desired values in the "Switch on settings" area.

3.9 Startup ramp "Startup ramp"

Function description "Startup ramp"

Function "Startup ramp" ensures that the set value of the effective power is achieved with a linear ramp when connecting the device to the grid.

Switching on "Startup ramp"

1. To switch on the function:
 - In the main menu, click on *>Operation >AC-DC module settings*.
2. In the "AC-DC module settings" area under "Activate startup ramp after next power stage activation", select: "Active".

or

- Modbus ID 4282

The function is switched on.

The function can also be switched on and off during running operation.

Parameterization "Startup ramp"

All adjustable parameters are listed in the following table.

Parameter	Description	Unit	Adjustment range		Factory settings	Step size
			Minimum	Maximum		
Startup ramp slope	Slope of the startup ramp	%/min	6	3000	10	1

Adjustable parameters for function "Startup ramp"

Tab. 27

Enter parameters for "Startup ramp"

1. Select *>Configuration >ARN4105*.
2. In the "Active power limiting" area, enter the desired values in "Startup ramp slope".

More information about "Startup ramp"

The startup ramp starts when energy is fed to the grid for the first time.

The startup ramp is only active in discharging mode.

3.10 Power limiter "Active power limiting"

Function description "Active power limiting"

The "Active power limiting" function ensures that the maximum effective power P_{max} is achieved with a linear ramp.

If the function is switched on, a maximum effective power P_{max} can be specified for the AC-DC module.

The function actively intervenes as soon as the desired set value is greater than the set P_{max} value. The output effective power is limited to the specified P_{max} value and this P_{max} value is achieved with a linear ramp. The ramp has a slope of $0.5\% \times P_{nom}$ per second.

Switching on "Active power limiting"

1. To switch on the function:
 - In the main menu, click on *>Configuration*.
 - Select the grid code in the selection list: "ARN4105".
2. In the "Active power limiting" area under "Activate active power limit ramp", select: "Active".

The function is switched on.

Parameterization "Active power limiting"

All adjustable parameters are listed in the following table.

Parameter	Description	Unit	Adjustment range		Factory settings	Step size
			Mini-mum	Maxi-mum		
Pmax limit (Modbus ID: 4281)	Target value of the ramp	% of P_{nom}	0.00	200.00	150.00	0.01

Adjustable parameters for function "Active power limiting"

Tab. 28

Enter parameters for "Active power limiting"

1. Select *>Configuration >ARN4105*.

-
- 2. In the "Active power limiting" area, enter the desired values in "Pmax limit in % of Pnom".

4. ARN4110

4.1 Prerequisites for complying with ARN4110

To comply with ARN4110, external components must be integrated with whose help the requirements for effective power and reactive power as well as the function of the grid decoupling protection are implemented at the central connection point of the power generation plant. The entire system must be certified as a whole. The requirements described in the following are to be viewed as a guide and make no claim for completeness.

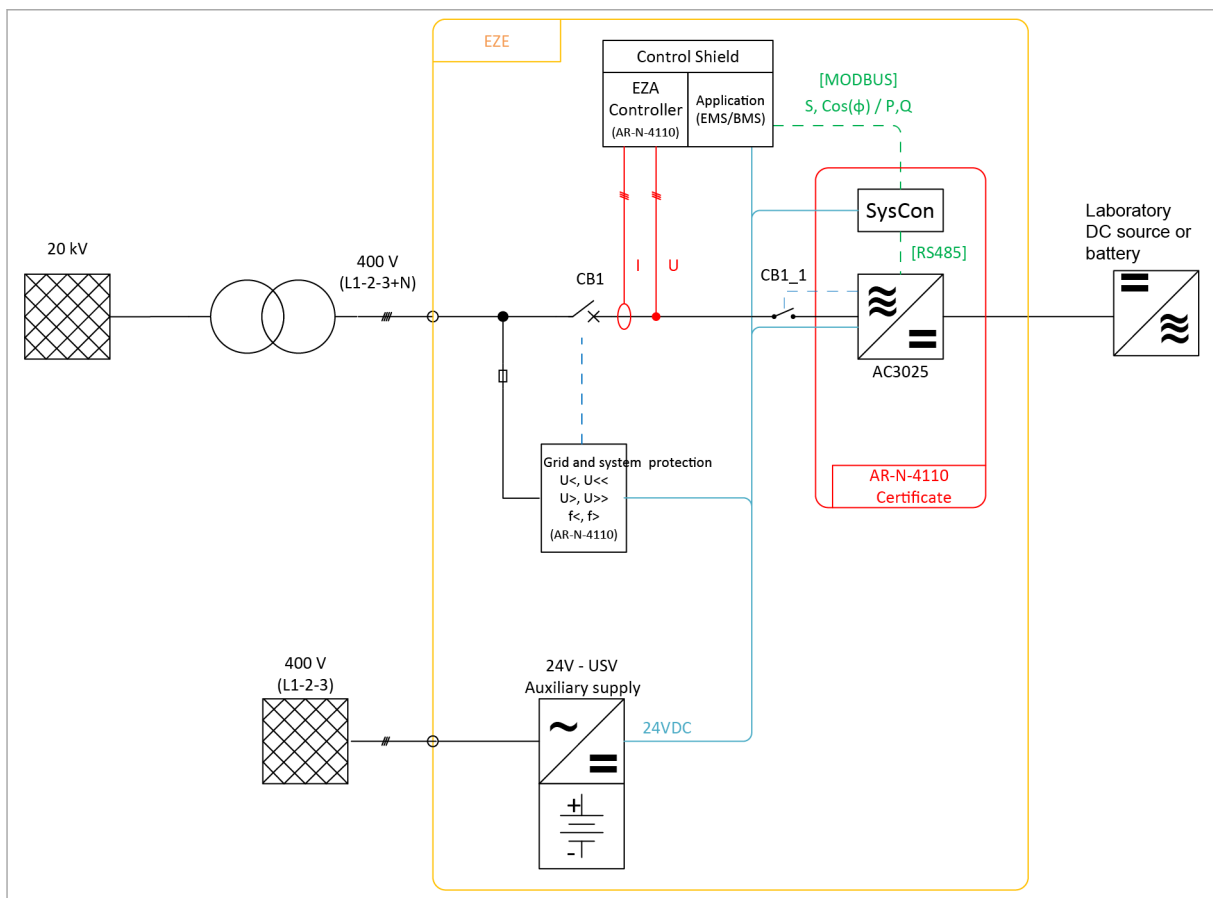

Necessary external components for ARN4110

Fig. 21

To operate the system as a complete power generation unit (PGU) or power generation plant (PGP), additional external components are necessary:

- Grid- and system protection (certified in accordance with ARN4110)
- Power plant controller (PPC) with corresponding measuring transformers (certified in accordance with ARN4110)

- FRT-capable 24-V power supply
- Grid-side and inverter-side switches (CB1, CB1_1) (see "Fig. 21", pg. 52).

Example for external components

Component	Manufacturer	Type	Other information
Current measuring transformers	WAGO	855-2701/064-001	64 A, accuracy class 1
Power measurement	WAGO	750-494/000-001	–
Power plant controller	WAGO	750-8212/025-001 (PFC200) + 2759-203/211-1000 (Power Plant Control)	SW component (certified in accordance with ARN4110) On PFC200, 2nd gen.
24-V _{DC} power supply unit	PULSE	QT20.241	24 V / 480 W
24-V _{DC} UPS	WAGO	787-870 + 787-876	24 V / 1.2 Ah Autonomy > 5 min
Grid- and system-protection	ZIEHL	UFR1001E	(certified in accordance with ARN4110)
Grid-side switch CB1	EATON	DILMP125(RDC24)	Note Design is application- and PCC-specific (point of common coupling).
Inverter-side switch CB1_1	EATON	DILMP125(RDC24)	–

Sample selection of the necessary external components Tab. 29

Certified regulator

The implementation of the static grid support or the processing of the set values for reactive power operation and effective power limiting is performed by a "PPC" (power plant controller). This PPC is a software module that runs on a PLC. The PPC prioritizes and coordinates the tasks of the grid operator and of the application. It then generates appropriate set values for the effective power and reactive power.

The components from manufacturer WAGO were selected as examples for the construction of the PPC (see "Tab. 29", pg. 53). To obtain certification for the WAGO PPC, it is to be implemented on a "PFC 200" model PLC of the second generation (or newer).

Solutions from other suppliers are permissible but must satisfy the following minimum requirements:

- Certification in accordance with VDE-AR-N4110 (valid version)
- Set value output via Modbus
- Compatibility with common remote control technologies (IEC 60870, radio receivers, binary inputs)

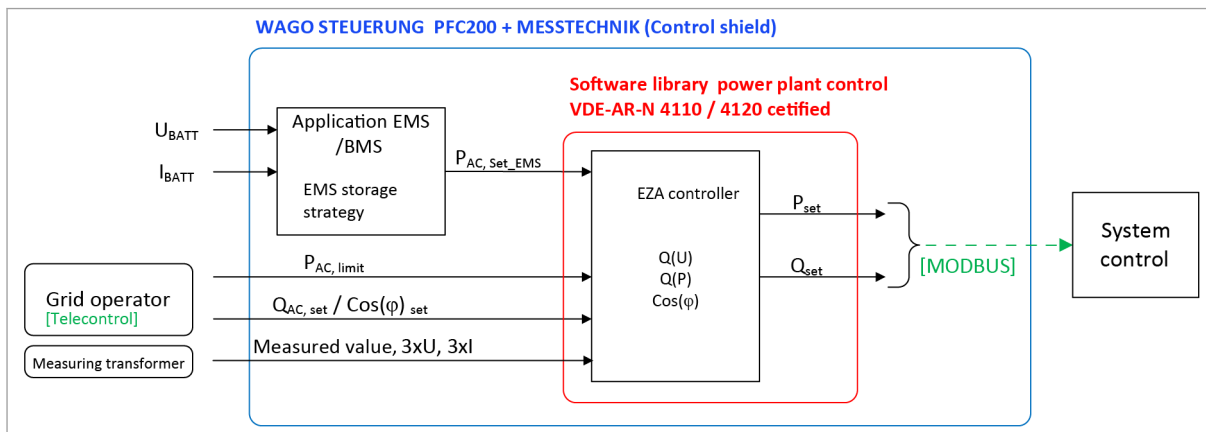

Example for set value processing in the central control (application + power plant controller)

Fig. 22

Signal	Meaning
U_{BATT}	Battery voltage
I_{BATT}	Battery current
P_{AC,SET_EMS}	Effective power set value of the energy or battery management system
$P_{AC_limiting}$	Effective power limiting by the grid operator
$Q_{AC_SET} / \text{Cos}(\varphi)_{SET}$	Reactive- or $\text{Cos}(\varphi)$ -specification by the grid operator
P_{SET}	Effective power specification from the certified PPC
Q_{SET}	Reactive power specification from the certified PPC

Explanation of the input and output signals of the PPC

Tab. 30

Measurement technology at the point of common coupling (PCC)

Current, voltage and power must be recorded by the central regulator at the point of common coupling. The measuring transformers must satisfy the requirements in chapter 6.2.2.7 of ARN4110.

Quote from ARN4110:"Measuring cores and measuring windings for the connection of power plant controllers for reactive power regulation / static voltage stability must satisfy at least class 0.5;

for connected apparent powers of the customer system > 1 MVA, at least class 0.2."

Grid- and system-protection

The function of the grid- and system-protection is ensured by an external grid- and system-protection (certified in accordance with ARN4110). This grid- and system-protection controls the central coupling switch CB1 (see "Fig. 23", pg. 55). Used as an example here is the UFR1001E device model from manufacturer Ziehl. The inverter controls switch CB1_1 via a built-in relay contact.

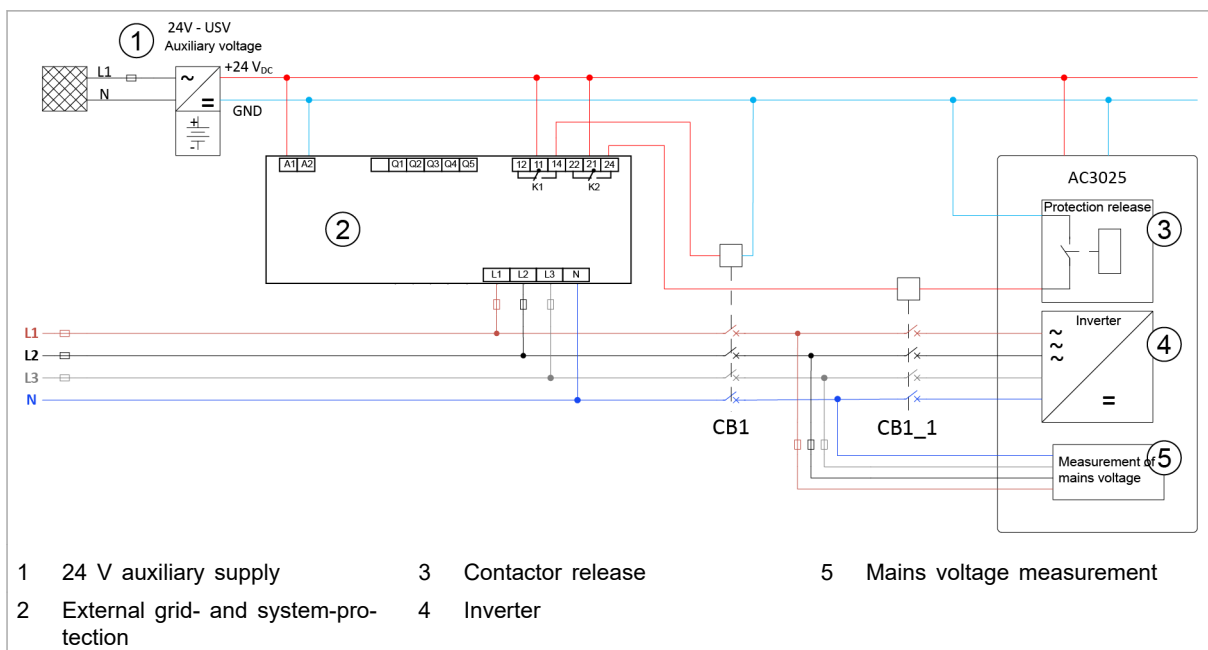

Example for the integration of intrinsic protection and decoupling protection

Fig. 23

Solutions from other suppliers are permissible but must satisfy the following minimum requirements:

- Certification in accordance with VDE-AR-N4110 (valid version)
- 3-phase grid monitoring
- Contactor release via 2 changeover relay contactors (K1, K2)
- Parameters can be protected with passwords

Manufacturer	Type
ABB	CM-UFD.M31
Ziehl	UFR1001E

Grid- and system-protection: Examples of providers and models

Tab. 31

Note

It must be possible to test the grid- and system-protection device **without** disconnecting wires. For this purpose, a test terminal strip is to be installed for contactor testing in accordance with section 11.4.17 of VDE-AR-N-4110:2018-11.

The TruConvert AC 3025 itself does not have a test terminal strip. The test terminal strip on the PGP level is to be designed on a project-specific basis.

Grid-side switch (CB1)

The grid-side switch (CB1) serves as a coupling switch and ensures 4-pole galvanic isolation.

Solutions from other suppliers are permissible but must satisfy the following minimum requirements:

Description	Condition	Unit	Description
Number of poles	$N \geq 3$	–	Corresponding PE design
Nominal current at 60 °C	$\geq 1.5 \times I_r \times N_{AC3025}$	A	N_{AC3025} is the number of TruConvert AC 3025 inverters connected in parallel within the PGP. For a single PGU, $N_{AC3025} = 1$.
Rated voltage	≥ 400	V _{AC}	–
Short-circuit current rating SCCR	n/a	kA	Design according to the short circuit power of the point of common coupling (PCC).
Control voltage	n/a	–	According to overall concept for auxiliary supply and control voltage.
Time delay (closing)	≤ 60	ms	–
Time delay (opening)	≤ 60	ms	–
Time for arc to extinguish	≤ 25	ms	–

Requirements on the grid-side switch CB1

Tab. 32

Auxiliary supply

The used auxiliary supply must have protection against voltage drops. This can be achieved with an additional UPS functionality. The UPS functionality can be covered by connecting an additional UPS before the 24 VDC power supply unit or using a 24 VDC power supply unit with integrated UPS functionality. The grid-side input of the auxiliary supply must be designed for a frequency range from 47 Hz to 53 Hz. Make certain that the input voltage range also maintains the HVRT limits of the selected nominal voltage from the feeder circuit.

The UPS functionality or the buffer must be designed so that autonomy of at least 5 s is ensured at maximum load of the auxiliary supply. This autonomy must be ensured even if the UPS buffer has reached the end of its regular service life.

The maintenance or preventative replacement of the battery or of the UPS buffer should be performed according to the information provided by the manufacturer, though no later than upon display of a warning message. The buffer does not necessarily need to be a battery.

Reactive power capacity when using ARN4110

The voltage-dependent reactive power capacity of the inverter changes if ARN4110 is selected under the grid codes.

The adjustable operating points or the operating range is defined according to image (see "Fig. 24", pg. 58) and table (see "Tab. 33", pg. 59). The nominal apparent power of 25 kVA is produced at every operating voltage from 0.85 to 1.15 p.u. (e.g., 85% to 115% of the nominal voltage) and over the entire effective-reactive power circuit.

If the effective power specification combined with the reactive power specification of the grid operator exceeds the entire apparent power capacity of the unit, the set value specification of the PPC is given priority and the effective power specification reduced accordingly.

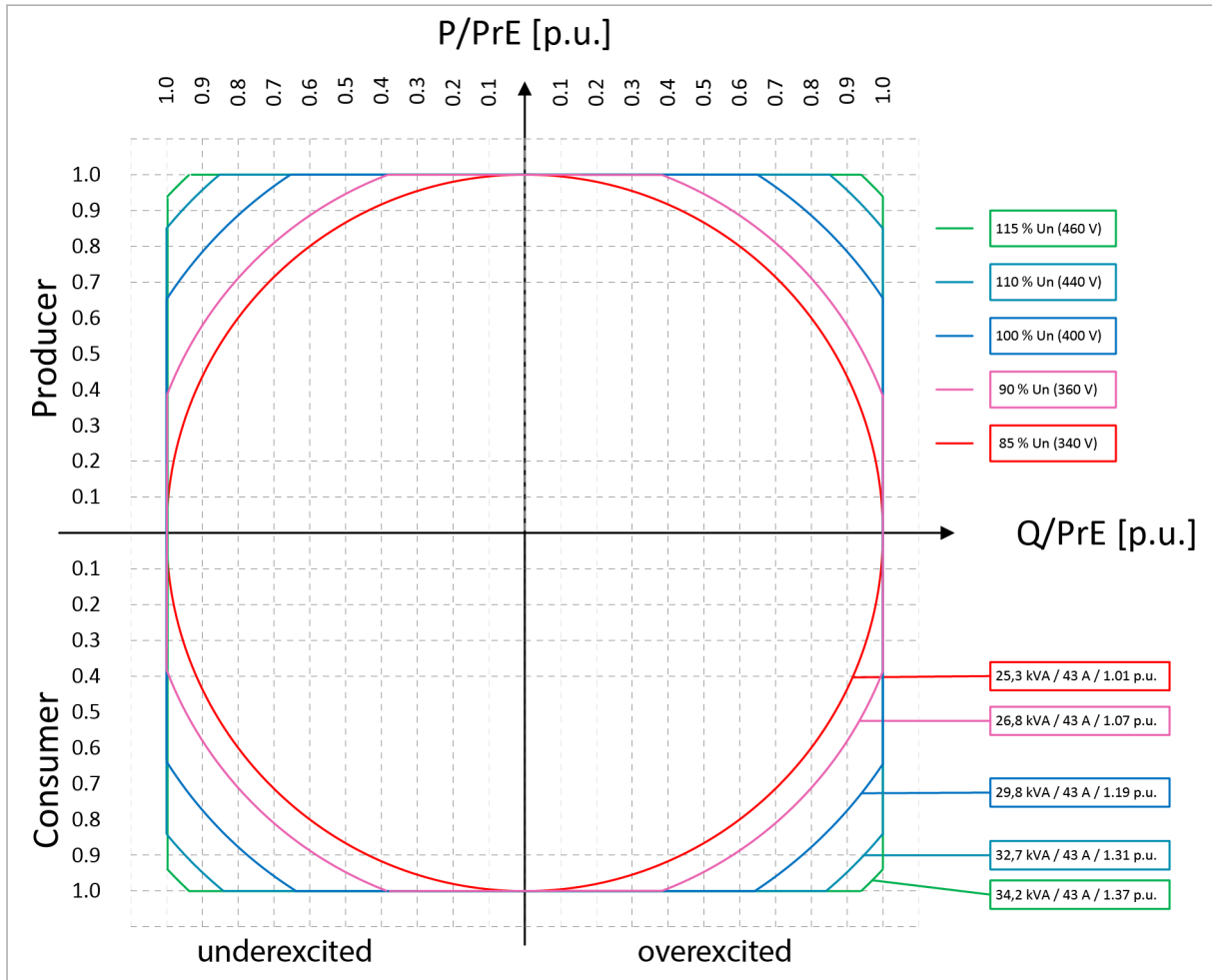

P-Q diagram for the function as storage in the voltage range 0.85 to 1.15 p.u.

Fig. 24

Voltage [p.u]	Effective power, P/PrE [p.u]	Q _{max} under/overexcited [p.u]
1.15	1	0.93
1.15	0.93	1
1.15	-0.93	1
1.15	-1	0.93
1.1	1	0.84
1.1	0.84	1
1.1	-0.84	1
1.1	-1	0.84
1	1	0.65
1	0.65	1
1	-0.65	1
1	-1	0.65
0.9	1	0.38
0.9	0.38	1
0.9	-0.38	1

Voltage	Effective power, P/PrE	Q _{max} under/overexcited
0.9	-1	0.38
0.85	1	0
0.85	0	1
0.85	0	1
0.85	-1	0

Maximum reactive power at corner points of voltage and reactive power Tab. 33

4.2 Hierarchy of the grid code functions

If several grid code functions are active at the same time, the function with the highest hierarchy level takes control.

Hierarchy	Name of the function	Meaning of the function
1	RT voltage	Dynamic grid support
2	P(f)	Effective power matching in the event of overfrequency and underfrequency

Hierarchy of the grid code functions Tab. 34

The individual functions are described separately in the further sections.

(See also "VDE-AR-N 4110.2018-11 – Technical requirements for the connection and operation of customer installations to the medium voltage network".)

Additional functions

Name of the function	Meaning of the function
Switch on criteria	Switch-on criteria

Additional functions Tab. 35

4.3 Dynamic grid support "RT voltage mode"

Function description "RT voltage mode"

The "RT voltage mode" function controls the behavior of the AC-DC module in the event of undervoltage and overvoltage on the mains grid.

Response in the event of a grid fault or rapid voltage change (voltage RT)

- The AC-DC module remains connected to the grid. Not until the grid fluctuations exceed the defined limits for one grid period is the device disconnected from the grid after a delay time. (see "Fig. 25", pg. 60)
- It is additionally possible to specify which mode the AC-DC module is to remain in while connected to the mains:
 - Mode 1 – Dynamic grid support:
Additional reactive currents in positive and negative phase-sequence system are impressed according to the specifications from ARN4110.
 - Mode 2 – Limited dynamic grid support:
The AC-DC module reduces its output apparent power to $S = 0$ kVA.

As long as the grid fluctuations are within the limit characteristic curves, the AC-DC module remains connected to the grid.

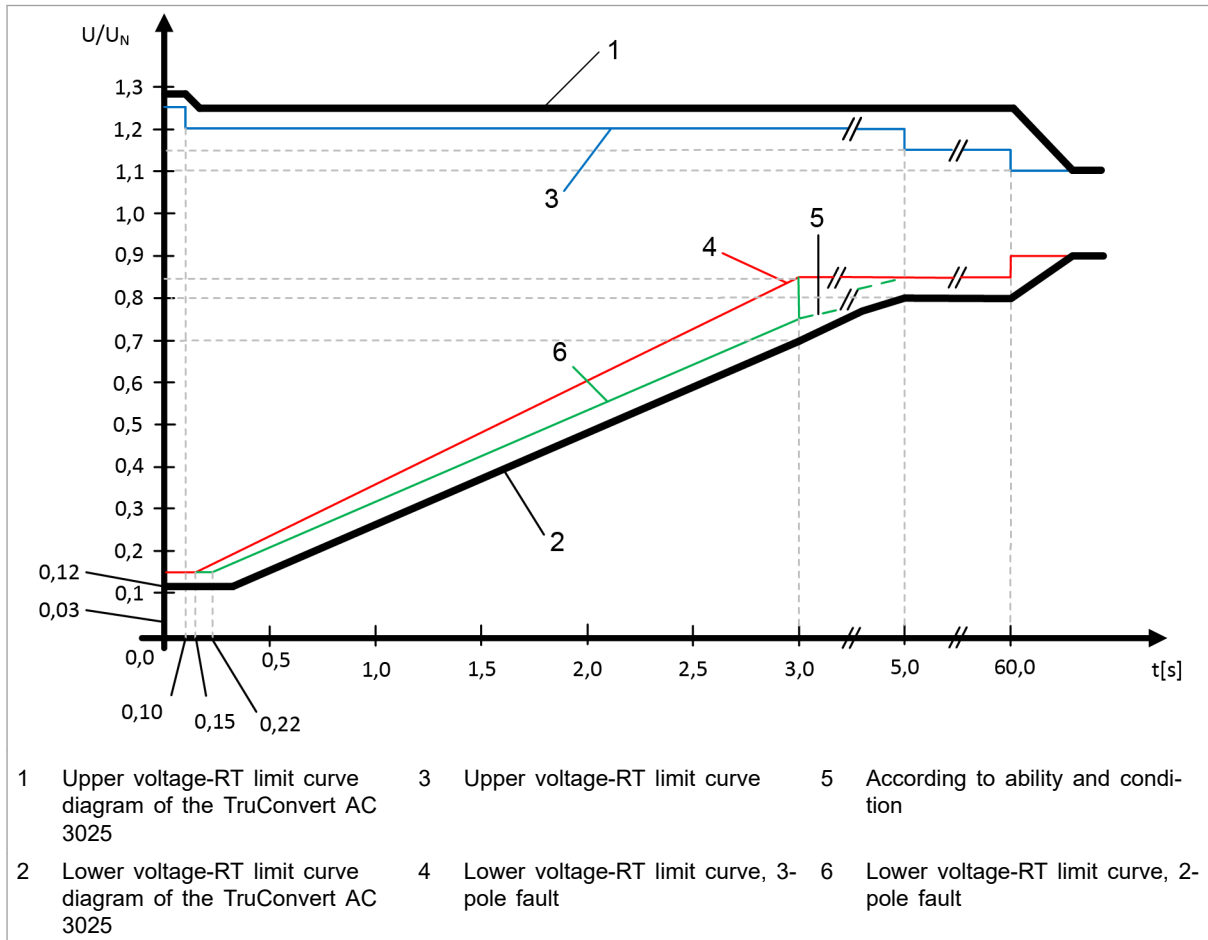

Voltage-RT limit curve of the AC-DC module

Fig. 25

Interpolation point no.	Time [s]	U [% Unom]
1	0.0	128
2	0.1	128
3	0.16	125
4	60.0	125
5	65.0	110
6	∞	110

Upper voltage RT limit curve: interpolation points for the implemented limit curve Tab. 36

Interpolation point no.	Time [s]	U [% Unom]
1	0.0	12
2	0.3	12
3	3.0	70
4	5.0	80
5	60.0	80
6	65.0	90
7	∞	90

Lower voltage RT limit curve: interpolation points for the implemented limit curve Tab. 37

Response in the event of grid faults

A grid fault is detected if the conductor-conductor voltages (relative to the average voltage) satisfies one of these criteria:

- The ±10% tolerance band of the rated voltage is undercut/ exceeded.
- The voltage rises or falls suddenly relative to the 1-minute average value of the pre-fault voltage.
(The mean voltage value is constantly calculated over the preceding minute.)

These two criteria are observed for each conductor-conductor voltage and identified as a voltage drop if the smallest of the three conductor-conductor voltages satisfies one of the criteria. Similarly, a voltage increase is identified if the largest of the three conductor-conductor voltages satisfies one of the criteria first.

Up until the end of the fault, the customer set values for effective and reactive power are ignored and the grid operator specifications satisfied instead.

The "RT voltage mode" function is active during charging and discharging mode.

Mode 1 – Dynamic grid support

If a grid fault occurs, a reactive current is impressed according to the set "K factor". For a voltage drop (LVRT), an overexcited reactive current is impressed. For a voltage increase (HVRT), an underexcited reactive current is impressed. Amplitude and angle of the individual currents are controlled to correspond to the required specifications for the positive and negative phase-sequence system.

The required reactive current is adjusted within 30 ms (response time) and stabilized within 60 ms (settling time).

The additional reactive current that is to be fed in is calculated from the voltage difference of the grid voltage from the 1-minute mean value of the voltage prior to the grid fault and the gain factor (see "Fig. 26", pg. 62). This equation applies for the positive and negative phase-sequence system.

$$\Delta I_B = k \times \Delta U$$

Fig. 26

Here, k is the gain factor and ΔU the relative voltage change relative to the agreed upon supply voltage U_C according to the equation:

$$\Delta U = \frac{U - U_{1min}}{U_C}$$

Fig. 27

ΔI_B is the additional reactive current that is impressed during a grid fault.

The calculation of the set value for the additional reactive current (see "Fig. 26", pg. 62) is performed separately for the positive and negative phase-sequence system.

The resulting reactive current from the pre-fault reactive current and impressed additional reactive current yields the reactive current due to FRT.

If the combination of effective current and the reactive current due to FRT exceeds the maximum apparent current, the effective current is reduced proportionally.

Mode 2 – Limited dynamic grid support

If the grid voltage is less than 70% of U_{nom} , the current is reduced to 0 A on all phases as quickly as possible (max. 30 ms).

Response after the grid fault has ended

Grid fault is ended if one of these criteria is satisfied:

- All grid voltages return to the $\pm 10\%$ tolerance band.
The AC-DC module restores the pre-fault values for effective and reactive power (max. 1 s).
- 5 s have passed since the start of the grid fault without the grid voltages returning to the $\pm 10\%$ tolerance band.
The AC-DC module restores the pre-fault values for effective and reactive currents (max. 1 s). This is performed using a PT1 response and a time constant $\tau = 200$ ms.
It is possible to declare the end of the fault due to a timeout if:
 - A sudden voltage change within $\pm 10\%$ of the tolerance band has occurred. It is not possible to return to the tolerance band because it was never left.
 - At least one voltage left the $\pm 10\%$ tolerance band and did not return to the $\pm 10\%$ tolerance band.

Switching on "RT voltage mode"

1. Select *>Configuration >ARN4110*.
2. In the "Grid code modes" area under "RT voltage mode", select: "Active".

The function is switched on.

Parameterization "RT voltage mode"

All adjustable parameters are listed in the following table.

Parameter	Description	Unit	Adjustment range		Factory settings	Step size
			Minimum	Maximum		
Calculation mode	Type of grid support <ul style="list-style-type: none"> ▪ 1: Normal (dynamic grid support) ▪ 2: Restricted (limited dynamic grid support) 	–	1	2	1	1
K factor	Gain factor Set according to the specifications of the grid operator.	–	0.0	6.0	2.0	0.1

Adjustable parameters for function "RT voltage mode"

Tab. 38

Enter parameters for "RT voltage mode"

1. Select >Configuration >ARN4110.
2. Enter the desired values in the "Voltage Ride Through settings" area.

More information about "RT voltage mode"

Disconnection from the grid if the voltage drops below the minimum voltage

There is an additional limitation for the overvoltage: The battery voltage or DC link voltage present at the time of the overvoltage. The necessary battery voltage or DC link voltage is depicted as a function of the voltage increase.

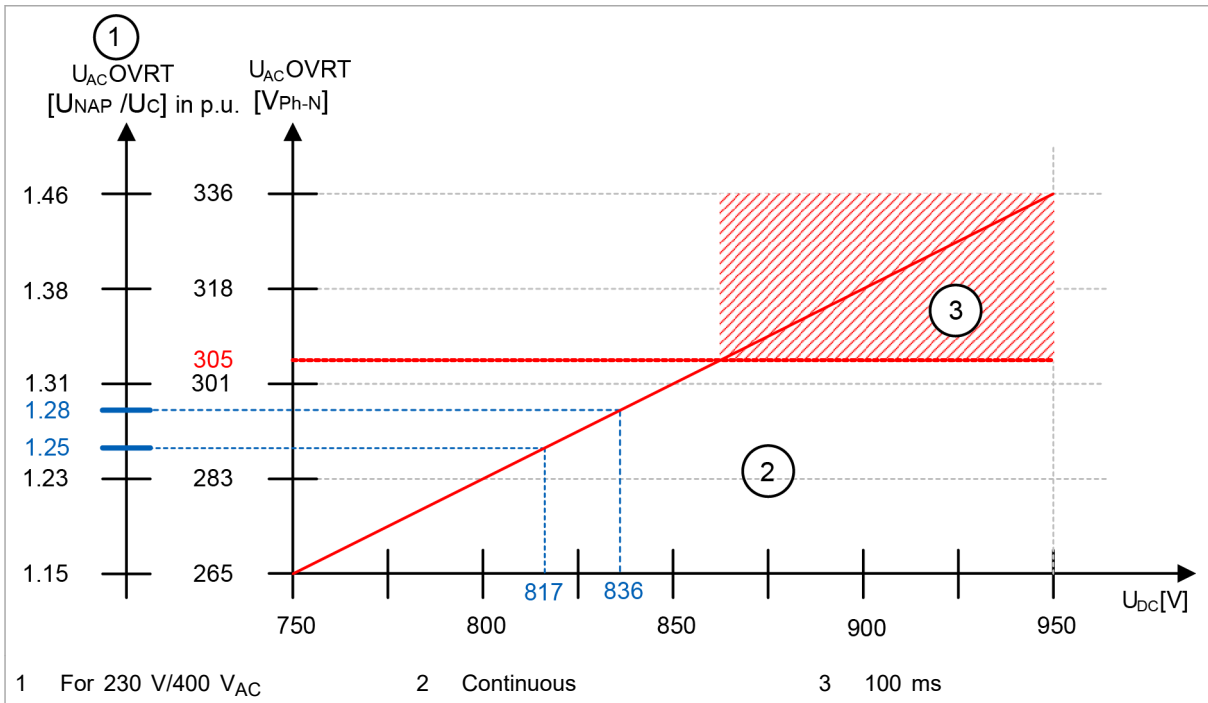

Minimum requirements for the overvoltage capability of the device

Fig. 28

If the battery voltage or DC link voltage is below the required minimum voltage during a grid-side overvoltage, there is a risk that uncontrolled current could flow from the grid towards the battery. To protect the AC-DC module and the battery, the AC-DC module disconnects itself from the grid.

To guarantee the overvoltage capability, the minimum DC link voltage must be adjusted according to the selected AC grid voltage:

- Overvoltage capability of 125%: $U_{dc_min} = 817 \text{ V}$.
(Minimum requirement according to standard)
- Overvoltage capability of 128%: $U_{dc_min} = 836 \text{ V}$.
(maximum overvoltage capability of the TruConvert AC 3025)

Note

If the battery is directly connected to the DC link, ensure the following:

The OCV battery voltage must be at least as large as the minimum voltage U_{dc_min} .

4.4 Effective power matching in the event of overfrequency and underfrequency "P(f) mode"

Function description "P(f) mode"

The "P(f) mode" function controls the effective power matching in the event of overfrequency and underfrequency.

This function allows a grid frequency that is dependent on effective power to be fed into or drawn from mains. The provided effective power follows a defined characteristic curve here.

Example characteristic curve for $P(f)$, here with $s_{\text{Overf}} = 5\%$,
 $s_{\text{Underf}} = 2\%$, $P_{\text{mom}} = 100\% \times P_{\text{b inst}}$:

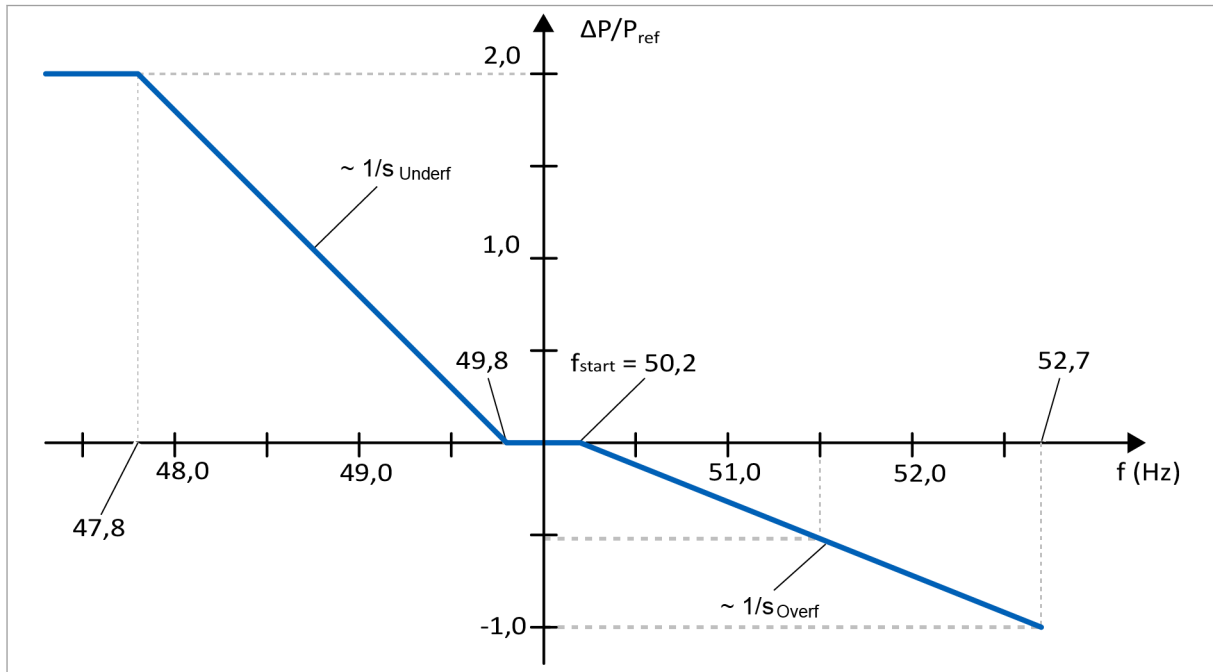

Characteristic curve of function $P(f)$

Fig. 29

The $P(f)$ function actively intervenes

In normal operation, the $P(f)$ function has no effect on the behavior of the inverter. It actively intervenes as soon as the defined tolerance band is exited. At this point in time, there is a critical grid condition and apparent power S , $\cos\phi$ power factor and the phase shift can no longer be changed. The function is active and orients itself according to the $P(f)$ characteristic curve.

Tolerance band:

Underf: frequency start $\leq f_{\text{Grid}} \leq$ Overf: frequency start

Return to normal operation

If the grid frequency is again within the defined tolerance band, the output power has again reached its pre-fault value for apparent power S and power factor $\cos\phi$. There is, however, still a critical grid condition. For a duration of 10 min or for the time defined for the alarm mode, all set value changes of the effective power are limited by a fixed gradient. The value of the gradient is $8\% P_{\text{b inst}}/\text{min}$.

The critical grid condition ends after the grid frequency has been within the permissible tolerance band for a full 10 min. All restrictions associated with this condition are thereby suspended.

Requirements on the reactive power

The effective power P is specified by the $P(f)$ characteristic curve. No requirements are placed on the reactive power, however.

To keep from further straining the grid during a critical grid condition, the reactive power is held as constant as possible. To do



this, the current reactive power is stored upon exiting the tolerance band and this value maintained.

If the maximum apparent power is not sufficient for satisfying the effective power requirement, the provided reactive power is reduced to the benefit of the effective power.

Switching on "P(f) mode"

1. Select >Configuration >ARN4110.
2. In the "Grid code modes" area under "P(f) mode", select: "Active"

The function is switched on.

Parameterization "P(f) mode"

All adjustable parameters are listed in the following table.

Parameter	Description	Unit	Adjustment range		Factory settings	Step size
			Minimum	Maximum		
Overf: frequency start f_{start}	Overfrequency limit	Hz	50.2	50.5	50.2	0.01
Underf: frequency start	Underfrequency limit	Hz	45.0	49.8	49.8	0.01
Overf: reference power	Reference for the calculation of the power reduction/increase	–	0: Maximum power	1: Momentarily power	1: Momentarily power	1
Underf: reference power	Reference for the calculation of the power reduction/increase	–	0: Maximum power	1: Momentarily power	1: Momentarily power	1
Overf: s s	Droop of the frequency-dependent supply of effective power in the case of overfrequency	%	2.0	12.0	5.0	0.1
Underf: s s	Droop of the frequency-dependent supply of effective power in the case of underfrequency	%	2.0	12.0	5.0	0.1
Charge_discharge_switch	If activated, it is possible to switch from charging mode to discharging mode and vice versa. If deactivated, then stop at S = 0 kVA.	–	0: No switch possible	1: Switch possible	1: Switch possible	1

Parameter	Description	Unit	Adjustment range		Factory settings	Step size
			Minimum	Maximum		
Alarm mode: slope	Maximum allowed slope of the effective and reactive power change in the critical grid condition.	% P _{binst} /min	0	10	8	1
Alarm mode: duration	Time delay until the critical grid condition has ended.	s	1	36000	600	1

Abbreviations: s = droop; f = frequency; S = apparent power

Adjustable parameters for function P(f)

Tab. 39

Parameter	Description
Overf: frequency start f _{start,Overf} Underf: frequency start f _{start,Underf}	<p>These are the upper limit and lower limit of the frequency tolerance band. The limits can be set within the specified value range.</p> <p>If the grid frequency exits the tolerance band, the P(f) function takes control and adjusts the output effective power according to the set P(f) curve.</p> <p>If the upper or lower limit is reached, the value of the momentary effective power P_{mom} is stored. Here, the value P_{mom} is the average value of all 3 phases. This value P_{mom} is adjusted by the amount ΔP and thereby forms the adapted power P_{adapted}.</p> $P_{adapted} = P_{mom} - \Delta P$
Overf: s s _{Over}	<p>This droop is defined for the case of an overfrequency.</p> <p>The droop is adjustable within the specified value range. It corresponds to a power ramp of:</p> <ul style="list-style-type: none"> ▪ At s = 2% ⇒ 100% P_{ref} per hertz ▪ At s = 12% ⇒ 16.67% P_{ref} per hertz <p>P_{ref} is the reference value for the droop.</p>
Overf: reference power P _{ref,Overf}	<p>This is the reference value for the droop in the event of overfrequency.</p> <p>It corresponds to either the installed power P_{b_inst} or the stored power P_{mom}. Here, the installed power P_{b_inst} is equivalent to the rated effective power PrE, since only one generator unit is considered.</p>
Underf: s s _{Underf}	<p>The droop is defined for the case of an underfrequency.</p> <p>The droop is adjustable within the specified value range. It corresponds to a power ramp of:</p> <ul style="list-style-type: none"> ▪ At s = 2% ⇒ 100% P_{ref_down} per hertz ▪ At s = 12% ⇒ 16.67% P_{ref_down} per hertz <p>P_{ref} is the reference value for the droop.</p>
Underf: reference power P _{ref,Underf}	<p>This is the reference value for the droop in the event of underfrequency.</p> <p>It corresponds to either the installed power P_{b_inst} or the stored power P_{mom}. Here, the installed power P_{b_inst} is equivalent to the rated effective power PrE, since only one generator unit is considered.</p>

Parameter	Description
Charge-discharge switch	Automatic switching between charging and discharging while characteristic curve P(f) is being traversed can be permitted or prohibited. <ul style="list-style-type: none"> ▪ 0: No switch possible At the time of switching, the output power at P = 0 kW is fixed. ▪ 1: Switch possible A change from producer to load and vice versa is permitted.
Alarm mode: slope	Maximum allowed slope of the effective and reactive power change in the critical grid condition.
Alarm mode: duration	Time in seconds after the return to the tolerance band until end of the critical grid condition. Each new violation of the tolerance band resets the counter.

Description of the parameters

Tab. 40

Enter parameters for "P(f) mode"

1. Select >Configuration >ARN4110.
2. In the "P(f) mode settings" area enter the desired values.

More information about "P(f) mode"

Calculation of the adapted power

In the event of overfrequency, the power matching ΔP is calculated (abbreviations: s = droop; f = frequency):

$$\Delta P = \frac{f_{Grid} - f_{start,Overf}}{f_n} * \frac{1}{S_{Overf}} * P_{ref,Overf}$$

Fig. 30

In the event of underfrequency, the power matching ΔP is calculated:

$$\Delta P = \frac{f_{Grid} - f_{start,Underf}}{f_n} * \frac{1}{S_{Underf}} * P_{ref,Underf}$$

Fig. 31

The adapted power is then calculated:

$$P_{adapted} = P_{mom} - \Delta P$$

Fig. 32

Example

For better understanding, an example is given for overfrequency with the following parameters:

Description	Symbol	Value
Nominal frequency	f_n	50.00 Hz
Upper start frequency	f_{start}	50.20 Hz
Momentary grid frequency	f_{Grid}	51.40 Hz
Droop for overfrequency	$s = s_{discharge}$	2%
Stored value of the effective power upon reaching the upper starting frequency	$P_{ref} = P_{mom}$	80% of $P_{b\ inst}$
Charge-discharge switch	–	True

Tab. 41

Reference power equal to momentary power ($P_{ref} = P_{mom}$) yields the following power matching ΔP :

$$\Delta P = \frac{51.40 - 50.20}{50} * \frac{1}{2\%} * 0.8 * P_{b\ inst} = 0,96 * P_{b\ inst}$$

Fig. 33

And, thus, the following power:

$$P_{adapted} = 0.80 * P_{b\ inst} - 0.96 * P_{b\ inst} = -0.16 * P_{b\ inst}$$

Fig. 34

For the given example, the power of the AC-DC module is adapted from 80% supply to 16% reference.

Upon return to the defined tolerance band and until the critical grid condition has ended, power matching occurs according to the currently measured frequency f_{Grid} (traversal of the characteristic curve).

Droops can only take positive values (grid-supporting feedback). In the event of overfrequency, the supply power is reduced or the draw from the grid increased. In the event of underfrequency, the supply power is increased or the draw from the grid reduced.

4.5 Switch-on criteria "Switch on criteria"

Function description "Switch on criteria"

The grid voltage and grid frequency must move within a defined range for a certain period of time; only then can the AC-DC module be connected. If the conditions are not satisfied, a corresponding alarm message is displayed ("Grid does not match grid code requirements.").

The AC-DC module expects an external command in order to reconnect to the grid. Switching back on does not occur automatically.

Switching on "Switch on criteria"

1. Select *>Configuration >ARN4110*.
2. In the "Grid code modes" area under "Switch on criteria", select: "Active".

The function is switched on.

Parameterization "Switch on criteria"

All adjustable parameters are listed in the following table.

Parameter	Description	Unit	Adjustment range		Factory settings	Step size
			Minimum	Maximum		
Voltage min	Minimum value for the grid voltage	p.u. of V_{nom}	0.80	0.99	0.85	0.01
Voltage max	Maximum value for the grid voltage	p.u. of V_{nom}	1.01	1.15	1.10	0.01
Frequency min	Minimum value for the grid frequency	Hz	44.0	49.9	47.5	0.1
Frequency max	Maximum value for the grid frequency	Hz	50.1	56.0	50.1	0.1
Time	Time span for the switch-on check	s	0.1	300.0	60.0	0.1

Possible parameter values for "Switch on criteria"

Tab. 42

Enter parameters for "Switch on criteria"

1. Select *>Configuration >ARN4110*.
2. Enter the desired values in the "Switch on settings" area.

5. EN50549-1

5.1 Hierarchy of the grid code functions

If several grid code functions are active at the same time, the function with the highest hierarchy level takes control.

The P(U) function can intervene parallel to the Q modes. From the functions of the Q modes, only one function can be selected in advance. Thus, only the selected function of the Q modes can intervene.

Hierarchy	Name of the function		Meaning of the function
0	Anti-islanding		Anti-islanding protection
1	RT voltage		Dynamic grid support
2	Bypass		Reduction of the output power to 0 kVA
3	P(f)		Effective power matching in the event of overfrequency and underfrequency
4	P(U)		Effective power matching in the event of overvoltage
4	Q modes	Q(U)	Reactive-power voltage curve Q(U)
4	Static voltage stability/ provision of reactive power	Constant cosPhi	Fixed power factor $\cos\phi$
4		cosPhi(P)	Power-factor/effective-power curve $\cos\phi$ (P)
4		Const Q	Constant provision of reactive power

Hierarchy of the grid code functions

Tab. 43

The individual functions are described separately in the further sections.

(See also "EN50549-1:2019 – Requirements for generating plants to be connected in parallel with distribution networks".)

Additional functions

Name of the function	Meaning of the function
Step response for Q	Step response behavior for reactive power Q These additional functions change the behavior of the Q(U), Constant cos(Phi), cosPhi(P) and RT voltage functions.
Switch on criteria	Switch-on criteria
Startup ramp	Startup ramp
Active power limiting	Power limiter

Additional functions

Tab. 44

5.2 Anti-islanding protection

Switching on Anti-islanding protection

If inadvertent isolated operation is detected, the AC-DC module is switched off within 2 s.

This function is always switched on if "grid-tied system" is selected. The function is active in the background no matter whether other grid code functions are activated.

1. Select *>Operation >AC-DC module settings*.
2. Under "Grid voltage", enter the grid voltage and grid frequency as well as the operating mode:
 - 400 V / 50 Hz, 480 V / 60 Hz, ...
 - Grid-tied or isolated operation

5.3 Dynamic grid support "RT voltage mode"

Function description "RT voltage mode"

The "RT voltage mode" function controls the behavior of the AC-DC module in the event of undervoltage and overvoltage on the mains grid.

Behavior in the event of extreme grid fluctuations:

- The AC-DC module remains connected to the grid. Not until the grid fluctuations exceed the defined limits for one grid period is the device disconnected from the grid after a delay time. (see "Fig. 8", pg. 30)
- The AC-DC module reduces its output apparent power to $S = 0$ kVA.

As long as the grid fluctuations are within the limit characteristic curves, the AC-DC module remains connected to the grid.

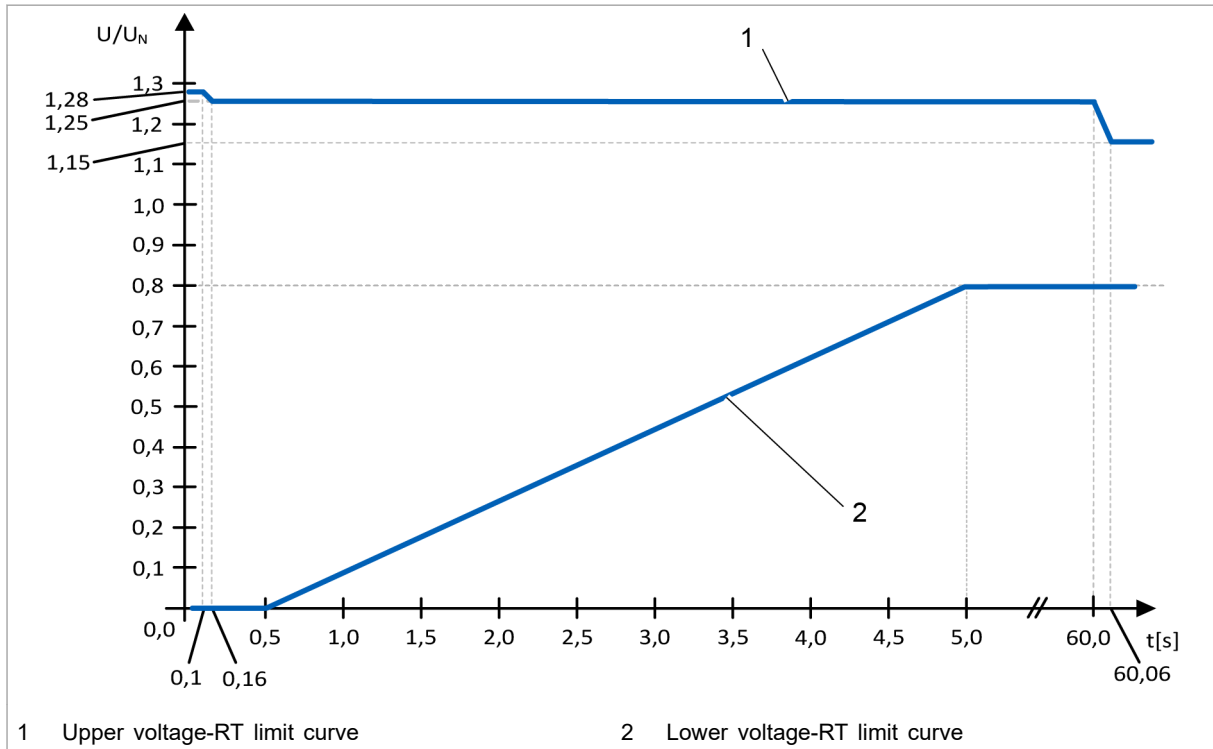

1 Upper voltage-RT limit curve

2 Lower voltage-RT limit curve

Fig. 35

Voltage-RT limit curve of the AC-DC module

Interpolation point no.	Time [s]	U [% Unom]
1	0.0	128
2	0.1	128
3	0.16	125
4	60.0	125
5	60.06	115
6	∞	115

Upper voltage RT limit curve: interpolation points for the implemented limit curve

Tab. 45

Interpolation point no.	Time [s]	U [% Unom]
1	0.0	0
2	0.5	0
3	5.0	80
4	∞	80

Lower voltage RT limit curve: interpolation points for the implemented limit curve

Tab. 46

If the grid voltage is less than 85% of U_{nom} or greater than 115% of U_{nom} , the output apparent power is reduced to 0 kVA as quickly as possible (max. 60 ms).

This is a critical grid condition and the inverter is in grid-supporting operation: apparent power S , power factor $\cos\phi$ and the phase position can no longer be changed. All entries for these

quantities are ignored as long as grid-supporting operation is active.

As soon as the grid fault has ended, the AC-DC module attempts to restore the pre-fault value. This occurs either immediately or by means of a PT1 behavior (see ["Switching on Step response for Q"](#), pg. 46).

Grid fault is ended if the outer conductor - neutral conductor voltages of the device are again within the range: $-15\% U_{nom}$ to $+15\% U_{nom}$.

The "RT voltage mode" function is active during charging and discharging mode.

Switching on "RT voltage mode"

1. To switch on the function:
 - In the main menu, click on *>GRID CODE*.
 - Select the grid code in the selection list: "EN50549-1".
2. In the "Grid code modes" area under "RT voltage mode", select: "Active".

The function is switched on.

In addition to this function, a step response can be set. (see ["Switching on Step response for Q"](#), pg. 46)

Parameterization "RT voltage mode"

No parameters are adjustable.

More information about "RT voltage mode"

Disconnection from the grid if the voltage drops below the minimum voltage

There is an additional limitation for the overvoltage: The battery voltage or DC link voltage present at the time of the overvoltage. The necessary battery voltage or DC link voltage is depicted as a function of the voltage increase.

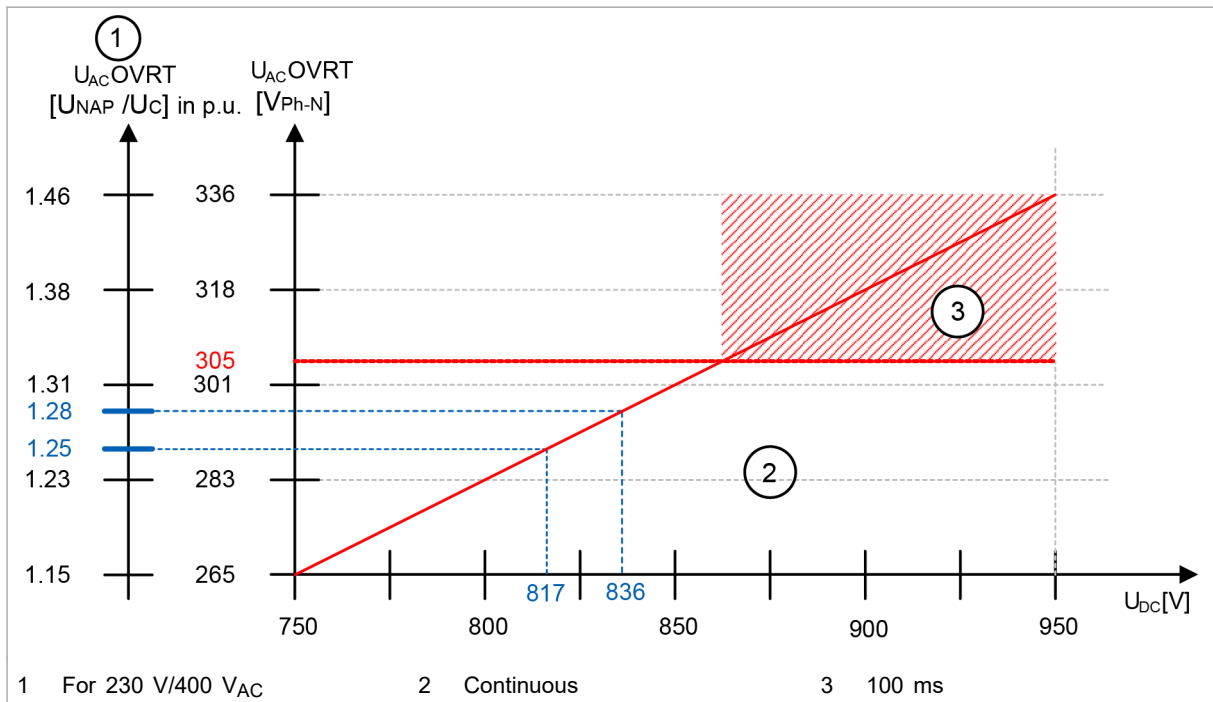

Minimum requirements for the overvoltage capability of the device

Fig. 36

If the battery voltage or DC link voltage is below the required minimum voltage during a grid-side overvoltage, there is a risk that uncontrolled current could flow from the grid towards the battery. To protect the AC-DC module and the battery, the AC-DC module disconnects itself from the grid.

To guarantee the overvoltage capability, the minimum DC link voltage must be adjusted according to the selected AC grid voltage:

- Overvoltage capability of 125%: U_{dc_min} = 817 V.
(Minimum requirement according to standard)
- Overvoltage capability of 128%: U_{dc_min} = 836 V.
(maximum overvoltage capability of the TruConvert AC 3025)

Note

If the battery is directly connected to the DC link, ensure the following:
The OCV battery voltage must be at least as large as the minimum voltage U_{dc_min}.

5.4 Bypass

Description of functions "Bypass"

The "Bypass" function immediately sets the output power to $S = 0$ kVA as soon as it is active.

Because the "Bypass" function has a higher priority than most grid codes, the power of the device can be set to $S = 0$ kVA even if a grid code is active.

Switching on "Bypass"

1. To switch on the function:
 - In the main menu, click on *>Operation >AC-DC module settings*.
2. In the "Grid code bypass function" area, select "1: Set S to 0 W".

The function is switched on.

The function can also be switched on and off during running operation.

Parameterization "Bypass"

All adjustable parameters are listed in the following table.

Parameter	Description	Unit	Adjustment range		Factory settings	Step size
			Minimum	Maximum		
Grid code bypass function (Modbus ID: 4280)	Activate/deactivate the bypass function. If active, the output power is set to $S = 0$ kVA.	–	0: Inactive	1: Set S to 0 W	0: Inactive	1

Adjustable parameters for function "Bypass"

Tab. 47

5.5 Effective power matching in the event of overfrequency and underfrequency "P(f) mode"

Function description "P(f) mode"

The "P(f) mode" function controls the effective power matching in the event of overfrequency and underfrequency.

This function allows a grid frequency that is dependent on effective power to be fed into or drawn from mains. The provided effective power follows a defined characteristic curve here.

Example characteristic curve for P(f), here with $s_{\text{Overf}} = 5\%$, $s_{\text{Underf}} = 2\%$, $P_{\text{mom}} = 100\% \times P_{\text{b inst}}$:

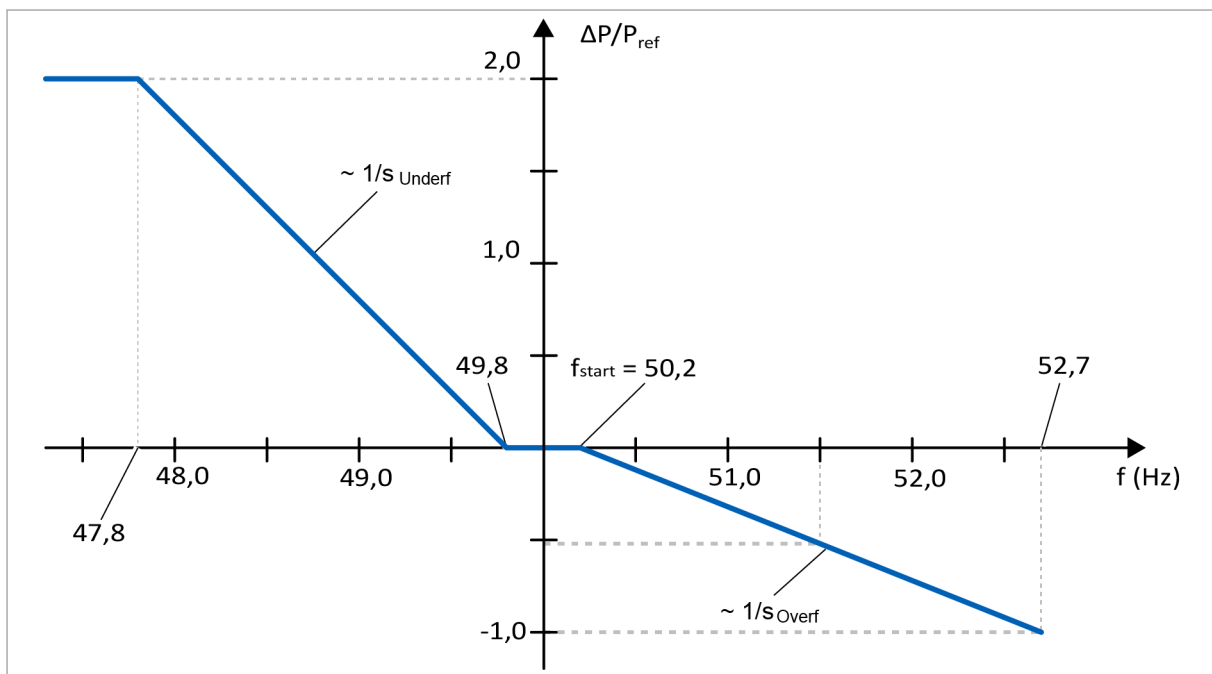

Characteristic curve of function P(f)

Fig. 37

The P(f) function actively intervenes

In normal operation, the P(f) function has no effect on the behavior of the inverter. It actively intervenes as soon as the defined tolerance band is exited. At this point in time, there is a critical grid condition and apparent power S , $\cos\phi$ power factor and the phase shift can no longer be changed. The function is active and orients itself according to the P(f) characteristic curve.

Tolerance band:

Underf: frequency start \leq f_Grid \leq Overf: frequency start

Which limits are taken into account can be set individually:

- "P(f) for overfrequency": The function is only active for overfrequency.
- "P(f) for underfrequency": The function is only active for underfrequency.
- "P(f) for over- and underfrequency": The function is active for overfrequency and underfrequency.

Return to normal operation

The end of the critical grid condition is reached as soon as the output effective power has again reached the pre-fault value. The return to normal operation varies depending on the set mode.

Return to normal operation depending on the set mode:

- "Stay On Curve":
If "Overf: frequency stop" \geq "Overf: frequency start (Stay On Curve)", the critical grid condition ends immediately after returning to the permissible frequency range.
- Alternative mode:
The critical grid condition ends after the set stop time has elapsed and the pre-fault value of the effective power has been reached with the set gradient.

Requirements on the reactive power

The effective power P is specified by the $P(f)$ characteristic curve. No requirements are placed on the reactive power, however.

To keep from further straining the grid during a critical grid condition, the reactive power is held as constant as possible. To do this, the current reactive power is stored upon exiting the tolerance band and this value maintained.

If the maximum apparent power is not sufficient for satisfying the effective power requirement, the provided reactive power is reduced to the benefit of the effective power.

Switching on "P(f) mode"

1. To switch on the function:
 - In the main menu, click on $>GRID CODE$.
 - Select the grid code in the selection list: "EN50549-1".
2. In the "Grid code modes" area under "P(f) mode", select:

- "P(f) for overfrequency"
The function is only active for overfrequency.
 - "P(f) for underfrequency"
The function is only active for overfrequency.
 - "P(f) for over- and underfrequency"
The function is active for overfrequency and underfrequency.
- The function is switched on.

Parameterization "P(f) mode"

All adjustable parameters are listed in the following table.

Parameter	Description	Unit	Adjustment range		Factory settings	Step size
			Minimum	Maximum		
Overf: frequency start	Overfrequency limit	Hz	50.2	52.0	50.2	0.1
Overf: time delay	Time delay for the start of the P(f) function	s	0.0	2.0	0.0	0.1
Overf: s charge	Droop of the frequency-dependent supply of effective power in the case of overfrequency during charging mode	%	2.0	12.0	5.0	0.1
Overf: s discharge	Droop of the frequency-dependent supply of effective power in the case of overfrequency during discharging mode	%	2.0	12.0	5.0	0.1
Overf: reference power	Reference for the calculation of the power reduction/increase	–	0: Maximum power	1: Momentarily power	1: Momentarily power	1
Overf: frequency stop	Overfrequency limit for deactivation	Hz	50.20	52.0	50.20	0.1
Overf: time stop	Time delay for exiting the P(f) function	s	0.0	600.0	0	0.1
All f: charge_discharge_switch	If activated, it is possible to switch from charging mode to discharging mode and vice versa. If deactivated, then stop at S = 0 kVA.	–	0: No switch possible	1: Switch possible	0: No switch possible	1
Underf: start	Underfrequency limit	Hz	45.0	49.80	49.80	0.1
Underf: time delay	Time delay for the start of the P(f) function	s	0.0	2.0	0.0	0.1
Underf: s charge	Droop of the frequency-dependent supply of effective power in the case of underfrequency during charging mode	%	2.0	12.0	5.0	0.1

Parameter	Description	Unit	Adjustment range		Factory settings	Step size
			Minimum	Maximum		
Underf: s discharge	Droop of the frequency-dependent supply of effective power in the case of underfrequency during discharging mode	%	2.0	12.0	5.0	0.1
Underf: reference power	Reference for the calculation of the power reduction/increase	–	0: Maximum power	1: Switch possible	0: Maximum power	1
Startup ramp slope	Slope of the startup ramp	%/min	6	3000	10	1

Abbreviations: s = droop; f = frequency; S = apparent power

Adjustable parameters for function P(f)

Tab. 48

Parameter	Description
Overf: frequency start Underf: start Overf: time delay Underf: time delay	<p>These are the upper limit and lower limit of the frequency tolerance band. The limits can be set within the specified value range.</p> <p>In addition, there is an adjustable time delay (dead time) for the overfrequency and the underfrequency.</p> <p>If the grid frequency exits the tolerance band for the set time delay, the P(f) function takes control and adjusts the output effective power according to the set P(f) curve.</p> <p>While the time delay is elapsing, the frequency must be permanently outside of the tolerance band in order for the P(f) function to take control. In the event that the frequency is again briefly within the tolerance band during the time delay, the timer is reset.</p> <p>If the upper or lower limit is reached, the value of the momentary effective power P_{mom} is stored. Here, the value P_{mom} is the average value of all 3 phases. This value P_{mom} is adjusted by the amount ΔP and thereby forms the adapted power $P_{adapted}$.</p> $P_{adapted} = P_{mom} - \Delta P$
Overf: s charge Overf: s discharge	<p>These 2 droops are defined for the case of an overfrequency. Which droop is used is dependent on whether the inverter is in charging mode or discharging mode at the time the frequency is exceeded.</p> <p>The droop is adjustable within the specified value range. It corresponds to a power ramp of:</p> <ul style="list-style-type: none"> ▪ At $s = 2\% \Rightarrow 100\% P_{ref}$ per hertz ▪ At $s = 12\% \Rightarrow 16.67\% P_{ref}$ per hertz <p>P_{ref} is the reference value for the droop.</p> <p>In the event of overfrequency: $P_{ref} = P_{mom}$.</p>
Overf: reference power	<p>This is the reference value for the respective droop in the event of overfrequency.</p> <p>It corresponds to either the installed power P_{b_inst} or the stored power P_{mom}. Here, the installed power P_{b_inst} is equivalent to the rated effective power PrE, since only one generator unit is considered.</p>

Parameter	Description
Underf: s charge Underf: s discharge	<p>These 2 droops are defined for the case of an underfrequency. Which droop is used is dependent on whether the inverter is in charging mode or discharging mode at the time the frequency is exceeded.</p> <p>The droop is adjustable within the specified value range. It corresponds to a power ramp of:</p> <ul style="list-style-type: none"> ▪ At $s = 2\% \Rightarrow 100\% P_{ref_down}$ per hertz ▪ At $s = 12\% \Rightarrow 16.67\% P_{ref_down}$ per hertz <p>P_{ref} is the reference value for the droop.</p> <p>In the event of underfrequency: $P_{ref} = P_{b_inst}$. P_{b_inst} is the installed power.</p>
Underf: reference power	<p>This is the reference value for the respective droop in the event of underfrequency.</p> <p>It corresponds to either the installed power P_{b_inst} or the stored power P_{mom}. Here, the installed power P_{b_inst} is equivalent to the rated effective power PrE, since only one generator unit is considered.</p>
Charge-discharge switch	<p>Automatic switching between charging and discharging while characteristic curve $P(f)$ is being traversed can be permitted or prohibited.</p> <ul style="list-style-type: none"> ▪ 0: No switch possible At the time of switching, the output power at $P = 0$ kW is fixed. ▪ 1: Switch possible A change from producer to load and vice versa is permitted.
Overf: frequency stop Overf: time stop	<p>This parameter can be used to activate an alternative $P(f)$ mode:</p> <ul style="list-style-type: none"> ▪ Standard mode "Stay On Curve": "Overf: frequency stop" = "Overf: frequency start" The effective power matching follows the set droop. ▪ Alternative mode: "Overf: frequency stop" < "Overf: frequency start" The effective power is reduced for a rising frequency according to the set droop. But the effective power is not increased again if the frequency drops. If the case of a decreasing frequency, the output power is kept constant until the frequency for the set stop time ("Overf: time stop") drops below "Overf: frequency stop". After the stop time has elapsed, the effective power increases incrementally with the set gradient ("Startup ramp slope"). This mode is only available for overfrequency.
Startup ramp slope	<p>Gradient with which the effective power again increases after the stop time has elapsed.</p> <p>(In the "Active power limiting" area under "Startup ramp slope")</p>

Description of the parameters

Tab. 49

Enter parameters for "P(f) mode"

1. Select >Configuration >EN50549-1.
2. Enter the desired values in the "P-mode settings" area.

More information about "P(f) mode"

Calculation of the adapted power

In the event of overfrequency, the power matching ΔP is calculated (abbreviations: s = droop; f = frequency):

$$\Delta P = \frac{f_{Grid} - f_{start}}{f_n} * \frac{1}{s} * P_{ref}$$

Fig. 38

In the event of underfrequency, the power matching ΔP is calculated:

$$\Delta P = \frac{f_{Grid} - 49,8 \text{ Hz}}{f_n} * \frac{1}{s} * P_{ref}$$

Fig. 39

The adapted power is then calculated:

$$P_{adapted} = P_{mom} - \Delta P$$

Fig. 40

Example

For better understanding, an example is given for overfrequency with the following parameters:

Description	Symbol	Value
Nominal frequency	f_n	50.00 Hz
Upper start frequency	f_{start}	50.20 Hz
Momentary grid frequency	f_{Grid}	51.40 Hz
Droop for overfrequency	$s = s_{discharge}$	2%
Stored value of the effective power upon reaching the upper starting frequency	$P_{ref} = P_{mom}$	80% of $P_{b \text{ inst}}$
Charge-discharge switch	–	True

Tab. 50

Reference power equal to momentary power ($P_{ref} = P_{mom}$) yields the following power matching ΔP :

$$\Delta P = \frac{51.40 - 50.20}{50} * \frac{1}{2\%} * 0.8 * P_{b_{inst}} = 0,96 * P_{b_{inst}}$$

Fig. 41

And, thus, the following power:

$$P_{adapted} = 0.80 * P_{b_{inst}} - 0.96 * P_{b_{inst}} = -0.16 * P_{b_{inst}}$$

Fig. 42

For the given example, the power of the AC-DC module is adapted from 80% supply to 16% reference.

Upon return to the defined tolerance band and until the critical grid condition has ended, power matching occurs according to the currently measured frequency f_{Grid} (traversal of the characteristic curve).

Droops can only take positive values (grid-supporting feedback). In the event of overfrequency, the supply power is reduced or the draw from the grid increased. In the event of underfrequency, the supply power is increased or the draw from the grid reduced.

5.6 Effective power matching in the event of overvoltage "P(U) mode"

Function description "P(U) mode"

The "P(U) mode" function controls the effective power matching in the event of overvoltage.

The function reduces the effective power as a function of the applied grid voltage.

There are 2 different modes:

- "Stay on curve"
- "Limitation of maximum power"

The schematic characteristic curve appears as follows:

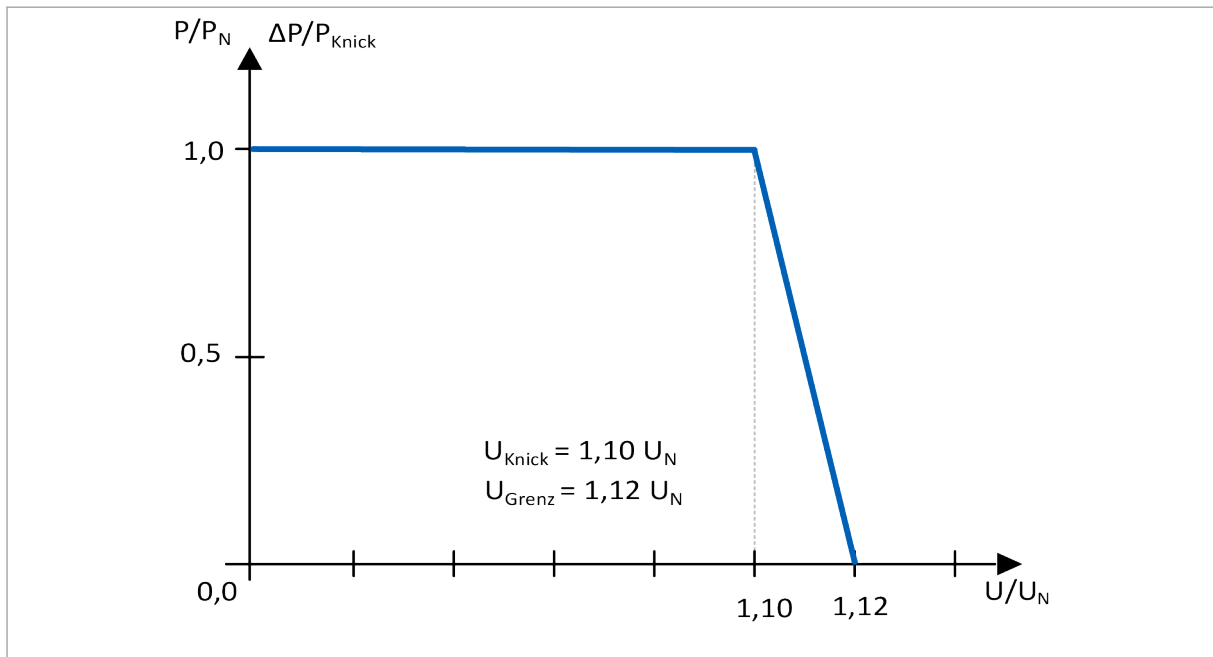

Characteristic curve of function P(U)

Fig. 43

The P(U) function actively intervenes

In normal operation, the P(U) function has no effect on the behavior of the inverter.

It actively intervenes as soon as:

- "Stay on curve":
The grid voltage exceeds the buckling voltage.
- "Limitation of maximum power":
The grid voltage exceeds the buckling voltage and, at the same time, the output effective power exceeds the power of the P(U) characteristic curve.

At this point in time, there is a critical grid condition and apparent power S , $\cos\phi$ power factor and the phase shift can no longer be changed. The function is active and orients itself according to the P(U) characteristic curve.

Return to normal operation

The critical grid condition ends as soon as:

- "Stay on curve":
The grid voltage drops below the buckling voltage again.
- "Limitation of maximum power":
The grid voltage drops below the buckling voltage again or the output power drops below the P(U) characteristic curve again.
- The P(U) function no longer intervenes and the pre-fault value is restored.

Requirements on the reactive power

The effective power P is specified by the P(U) characteristic curve. No requirements are placed on the reactive power, however.

To keep from further straining the grid during a critical grid condition, the power factor $\cos\phi$ is held as constant as possible. For this purpose, the momentary power factor $\cos\phi$ is stored and this value maintained upon occurrence of the critical grid condition. The reduction of the effective power thereby also results in a reduction of the reactive power.

Switching on "P(U) mode"

1. To switch on the function:
 - In the main menu, click on `>GRID CODE`.
 - Select the grid code in the selection list: "EN50549-1".
2. In the "Grid code modes" area under "Activate P(U) mode", select: "P(U)".

The function is switched on.

Parameterization "P(U) mode"

All adjustable parameters are listed in the following table.

Parameter	Description	Unit	Adjustment range		Factory settings	Step size
			Minimum	Maximum		
Calculation mode	Selection of the calculation mode	–	0: Stay on curve	1: Limitation of maximum power	0: Stay on curve	1
Buckling voltage	Buckling voltage	p.u. of V_{nom}	1.09	1.11	1.10	0.01
Cut-off voltage	Limit voltage	p.u. of V_{nom}	1.11	1.15	1.12	0.01
Activate step response for P	Activation of a PT1 behavior for P	–	0: Inactive	1: PT1 of P	1: PT1 of P	1
PT1 of P: tau	Time constant of the step response	s	1.0	60.0	5	0.1

Adjustable parameters for function P(U)

Tab. 51

Parameter	Description
Calculation mode Buckling voltage Cut-off voltage	<p>It is possible to select between two different calculation processes:</p> <ul style="list-style-type: none"> ▪ "Stay on curve": A start voltage is defined based on the defined buckling voltage "Buckling voltage". If the grid voltage exceeds this voltage at any time, the P(U) function takes control and adapts the output effective power according to the set P(U) characteristic curve. If the buckling voltage is reached, the value of the momentary effective power P_{mom} is stored. This value P_{mom} is adjusted by the amount ΔP. The output effective power reaches its minimum $P = 0$ kW at its limit voltage "Cut-off voltage". ▪ "Limitation of maximum power": The maximum effective power output is limited. If the effective power exceeds the characteristic curve at a given point in time, the output power is limited to the value of the P(U) characteristic curve. The limitation takes effect only for grid voltages that are greater than the buckling voltage. The output effective power reaches its minimum $P = 0$ kW at its limit voltage "Cut-off voltage".
Activate step response for P PT1 of P: tau	<p>For changes of the output effective power, a step response can be set. The step response defines the period in which the new value is reached. This allows either an abrupt or a more gradual change to be set.</p> <ul style="list-style-type: none"> ▪ Switching on the PT1 behavior: <ul style="list-style-type: none"> - Set parameter "Activate step response for P" to "1: PT1 of P". - Enter time constant τ ("PT1 of P: tau"). - The time constant τ determines the speed of the change here. After 3τ, approximately 95% of the set value is reached. ▪ Switching off the PT1 behavior: Set parameter "Activate step response for P" to "0: Inactive". If the PT1 behavior is switched off, the effective power reduction takes place without delay.

Description of the parameters

Tab. 52

Enter parameters for "P(f) mode"

1. Select *>Configuration >EN50549-1*.
2. In the "P(f) mode settings" area enter the desired values.

More information about "P(U) mode"

- The function only applies in discharging mode. In charging mode, all parameters are freely selectable.
- In addition, a PT1 behavior of the output reactive power can be activated. (see ["Switching on Step response for Q", pg. 98](#))

5.7 Static voltage stability/provision of reactive power "Q modes"

To aid the static grid support through reactive power, one of the following processes can be selected:

- Reactive power as a function of the grid voltage: "Q(U)"
- Fixed power factor $\cos\varphi$: "Constant $\cos\Phi$ "
- Power factor as a function of effective power: "CosPhi(P)"
- Constant provision of reactive power: "Q = const"

Reactive power as a function of the grid voltage: "Q(U)"

Function description "Q(U)"

Function "Q(U)" controls the provision of reactive power as a function of voltage.

This function allows a grid voltage that is dependent on reactive power to be fed into or drawn from grid. The provided reactive power follows a defined characteristic curve here.

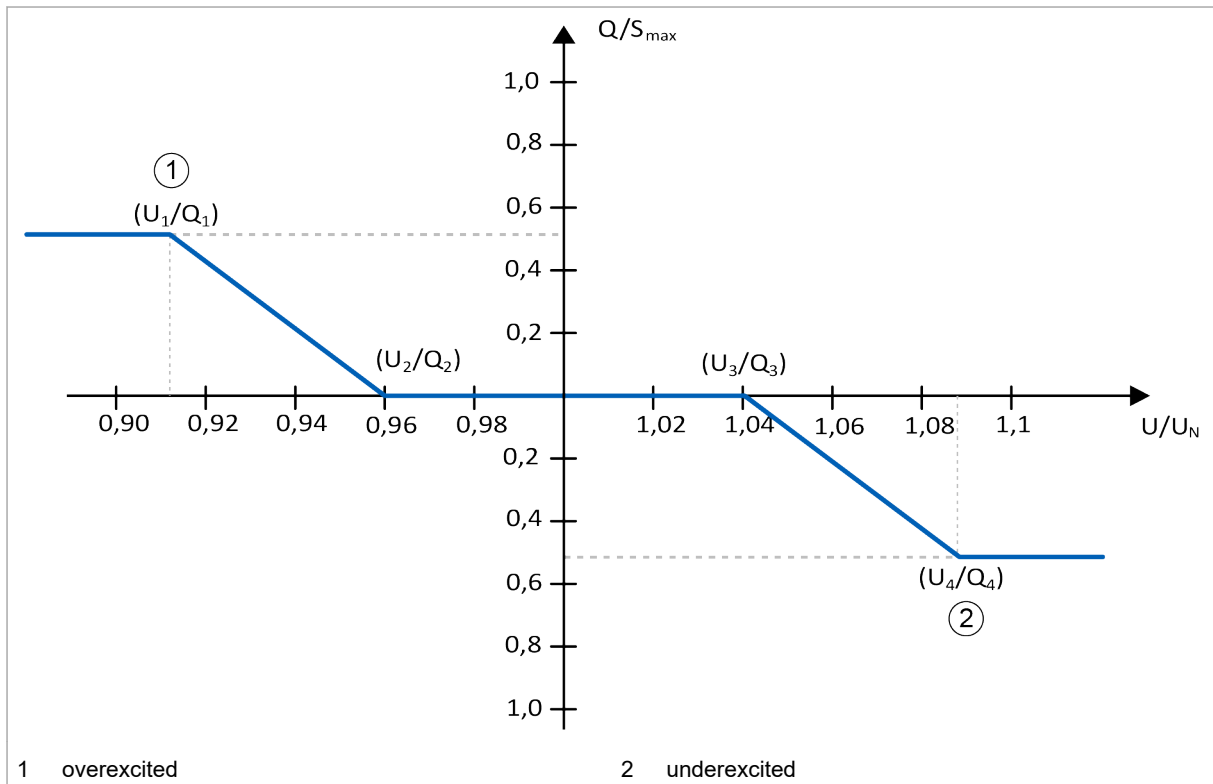

Fig. 44

Interpolation point no.	Voltage [U/U _N]	Reactive power [Q/S _{max}]
1	Voltage 1 (U1)	Q1
2	Voltage 2 (U2)	Q2
–	Unom	0.0
3	Voltage 3 (U3)	Q3 = Q2
4	Voltage 4 (U4)	Q4 = Q1

Interpolation points for the implemented characteristic curve Tab. 53

Within which value ranges the individual interpolation points lie is defined for each parameter. (see "Parameterization Q(U)", pg. 91)

In the AC-DC module, the power factor $\cos\varphi$ and the phase position can be specified for controlling the apparent power S.

With switched-on Q(U) function, the input of the set value for the apparent power ("Set value AC") is generally interpreted as effective power P.

- In normal operation, $\cos\varphi = 1$ is set.
- In the event of fault, $\cos\varphi$ is determined from the characteristic curve. The actually delivered/consumed apparent power is then determined from the set value specification ($\triangleq P$) and $\cos\varphi$.

By means of the Q(U) characteristic curve, the values of the power factor $\cos\varphi$ and the phase position are uniquely determined from the set value specification ($\triangleq P$) and the grid voltage. For this reason, if the function is actively intervening, the entered parameters of the power factor $\cos\varphi$ and of the phase position are ignored.

The power factor $\cos\varphi$ determined from the characteristic curve is calculated from the entered set value and the specified reactive power (characteristic curve).

$$\cos\varphi = \sqrt{1 - \frac{Q^2}{P^2 + Q^2}}$$

Fig. 45

Select from two different modes for the function

Two different modes can be selected for the Q(U) function:

- "Minimum cosPhi" mode
The value for the minimum $\cos\varphi$ is specified. The AC-DC module then tries to never drop below this value.
- "P lock" mode
Two power levels are specified: $P_{\text{lock in}}$ and $P_{\text{lock out}}$ (see "Fig. 46", pg. 91).
 - If the set effective power is greater than $P_{\text{lock in}}$, the Q(U) function actively intervenes.
 - If the set effective power is again less than $P_{\text{lock out}}$, the Q(U) function is again deactivated.
 If the Q(U) function is deactivated, $Q = 0$ is set.

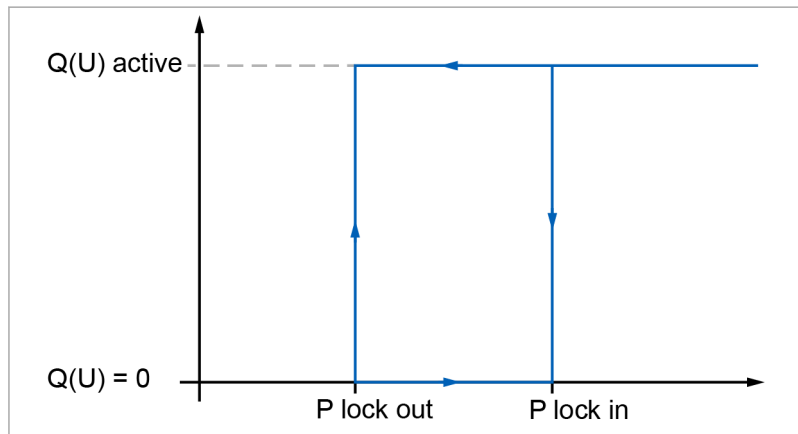

Activation of the Q(U) function through P_{lock}

Fig. 46

Switching on "Q(U)"

1. To switch on the function:
 - In the main menu, click on `>GRID CODE`.
 - Select the grid code in the selection list: "EN50549-1".
2. In the "Grid code modes" area under "Activate Q mode", select: "Q(U)".

The function is switched on.

Parameterization "Q(U)"

All adjustable parameters are listed in the following table.

Parameter	Description	Unit	Adjustment range		Factory settings	Step size
			Minimum	Maximum		
Q(U): voltage 1* U1	1st voltage interpolation point	p.u. of V_{nom}	0.85	0.95	0.93	0.01
Q(U): voltage 2* U2	2nd voltage interpolation point	p.u. of V_{nom}	0.95	0.99	0.97	0.01
Q(U): voltage 3* U3	3rd voltage interpolation point	p.u. of V_{nom}	1.01	1.05	1.03	0.01
Q(U): voltage 4* U4	4th voltage interpolation point	p.u. of V_{nom}	1.05	1.10	1.07	0.01
Q(U): Q2 and Q3	Reactive power at 2nd and 3rd voltage interpolation point Reactive power at the 1st and 4th voltage interpolation point	p.u. of S_{max}	0	1	0	0.001
Q(U): Q1 and Q4	Reactive power at the 1st and 4th voltage interpolation point	p.u. of S_{max}	0	1	0.436	0.001
Q(U): Mode	Difference between the various Q(U) modes	–	0: Minimum cosPhi	1: P lock	0: Minimum cosPhi	1
Q(U) min cosPhi: cosPhi	The minimum $\cos\varphi$ in Q(U) mode "Minimum cosPhi"	–	0	1	0.9	0.01
Q(U): P lock in**	The "P lock in" in Q(U) mode "P lock"	p.u. of S_{max}	0	1	0.2	0.01
Q(U): P lock out**	The "P lock out" in Q(U) mode "P lock"	p.u. of S_{max}	0	1	0.2	0.01
*) $U_{1-4} = x \% U_{nom}$, $U_{nom} = 231 V$						
**) $P_{lock\ in} - lock\ out = x\% S_{max}$						
Abbreviations: p.u. = per unit						

Adjustable parameters for function Q(U)

Tab. 54

Enter parameters for Q(U)

1. Select >Configuration >EN50549-1.
2. In the "Q mode settings" area, enter the desired values in "Q(U): ...".

More information about "Q(U)"

- In the event of overvoltage or undervoltage it may occur that the set apparent power is less than the required reactive



power (characteristic curve). In this case, the apparent power is automatically increased accordingly.

- The function only applies in discharging mode. In charging mode, all parameters are freely selectable.
- In addition, a PT1 behavior of the output reactive power can be activated. (see "Switching on Step response for Q", pg. 98)

Fixed power factor "Constant cosPhi"

Function description "Constant cosPhi"

With this function, a constant power factor $\cos\varphi$ and a constant phase position for discharging mode can be specified. By means of this constant power factor, it is ensured that some reactive power is always output to the grid.

In the AC-DC module, the power factor $\cos\varphi$ and the phase position can be specified for controlling the apparent power S . By selecting the "Constant cosPhi" function, the values of $\cos\varphi$ and the phase position are, for a given apparent power, uniquely determined by the grid code settings. For this reason, if the function is actively intervening, the entered parameters of the power factor $\cos\varphi$ and of the phase position are ignored. The set values are used instead.

Switching on "Constant cosPhi"

1. To switch on the function:
 - In the main menu, click on *>GRID CODE*.
 - Select the grid code in the selection list: "EN50549-1".
2. In the "Grid code modes" area under "Activate Q mode", select: "Constant cos(Phi)"

The function is switched on.

Parameterization "Constant cosPhi"

All adjustable parameters are listed in the following table.

Parameter	Description	Unit	Adjustment range		Factory settings	Step size
			Minimum	Maximum		
Constant cosPhi: cosPhi	Constant power factor in discharging mode	–	0.0	1.0	0.9	0.01
Phase pos (cosPhi=cst, Q=cst)	Constant phase position in discharging mode	–	0: capacitive	1: inductive	0: capacitive	–

Adjustable parameters for function Constant cosPhi

Tab. 55

Enter parameters for "Constant cosPhi"

1. Select >Configuration >EN50549-1.
2. In the "Q mode settings" area, enter the desired values in "Constant cosPhi".

More information about "Constant cosPhi"

- The function only applies in discharging mode. In charging mode, all parameters are freely selectable.
- In addition, a PT1 behavior of the output reactive power can be activated. (see ["Switching on Step response for Q"](#), pg. 98)

Power factor as a function of effective power "cosPhi(P)"

Function description "cosPhi(P)"

Function "cosPhi(P)" controls the provision of reactive power by means of a changed power factor $\cos\varphi$ as a function of the set effective power. The function can be used to output a specified reactive power to the grid as a function of the set effective power. This is implemented as the cosPhi(S) characteristic curve.

In the AC-DC module, the power factor $\cos\varphi$ and the phase position can be specified for controlling the apparent power S. By selecting the "cosPhi(P)" function, the values of $\cos\varphi$ and the phase position are uniquely determined for a given apparent power. For this reason, if the function is actively intervening, the entered parameters of the power factor $\cos\varphi$ and of the phase position are ignored. Instead, the values of the cosPhi(S) characteristic curve are used.

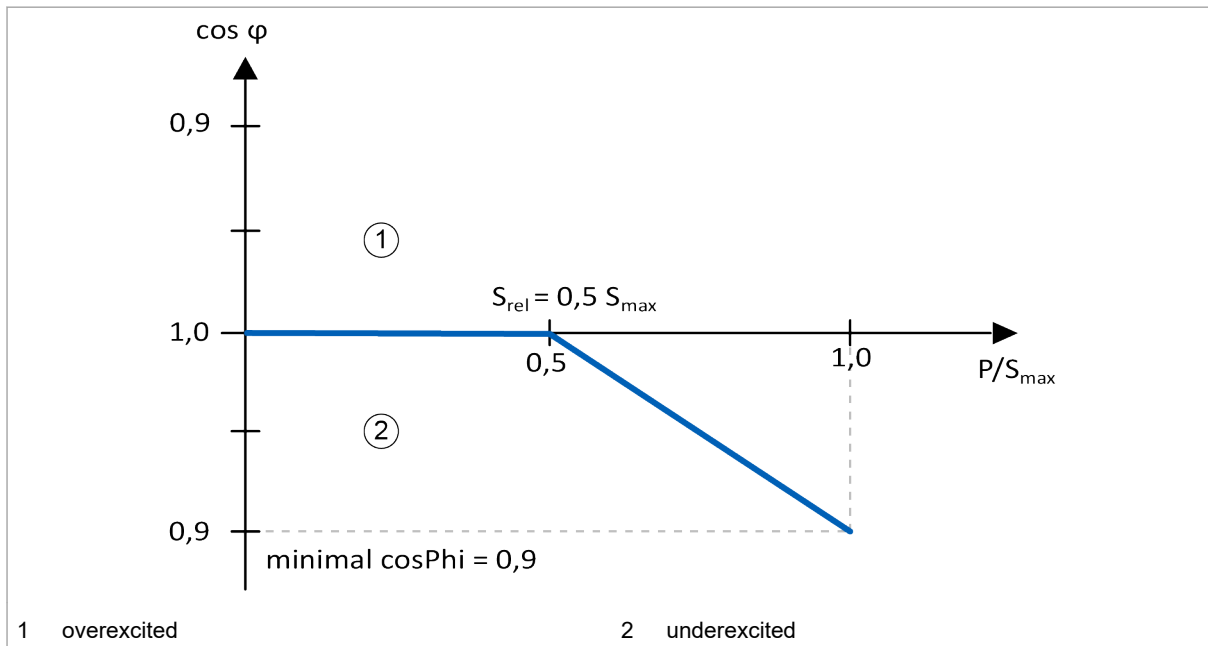

Fig. 47

Switching on "cosPhi(P)"

1. To switch on the function:
 - In the main menu, click on >GRID CODE.
 - Select the grid code in the selection list: "EN50549-1".
 2. In the "Grid code modes" area under "Activate Q mode", select: "cosPhi(P)"
- The function is switched on.

Parameterization "cosPhi(P)"

All adjustable parameters are listed in the following table.

Parameter	Description	Unit	Adjustment range		Factory settings	Step size
			Minimum	Maximum		
CosPhi(P): Srel	Start of the provision of reactive power	p.u. of S_{max}	0	1	0.5	0.01
CosPhi(P): minimal cosPhi	Minimal cosPhi at maximum power	-	0	1	0.9	0.01

Abbreviations: p.u. = per unit

Adjustable parameters for function "cosPhi(P)"

Tab. 56

Parameter	Description
CosPhi(P): Srel	For all set values of $S/S_{\max} < S_{\text{rel}}$, a fixed power factor of $\cos\varphi = 1$ is assumed. If the set value of S increases further, it follows the characteristic curve given above until it reaches its minimum power factor "minimal cosPhi".
CosPhi(P): minimal cosPhi	

Description of the parameters

Tab. 57

Enter parameters for "cosPhi(P)"

1. Select *>Configuration >EN50549-1*.
2. In the "Q mode settings" area, enter the desired values in "cosPhi(P)".

More information about "cosPhi(P)"

- The function only applies in discharging mode. In charging mode, all parameters are freely selectable.
- In addition, a PT1 behavior of the output reactive power can be activated. (see ["Switching on Step response for Q", pg. 98](#))

Constant provision of reactive power "Q = const"

Function description "Q = const"

The "Q = const" function controls the provision of reactive power by means of a constant reactive power value.

In the AC-DC module, the power factor $\cos\varphi$ and the phase position can be specified for controlling the apparent power S. By selecting the "Q = const" function, the values of $\cos\varphi$ and the phase position are uniquely determined for a given apparent power. For this reason, if the function is actively intervening, the entered parameters of the power factor $\cos\varphi$ and of the phase position are ignored. The set values are used instead.

Switching on "Q = const"

1. To switch on the function:
 - In the main menu, click on *>GRID CODE*.
 - Select the grid code in the selection list: "EN50549-1".

2. In the "Grid code modes" area under "Activate Q mode", select: "Constant Q"

The function is switched on.

Parameterization "Q = const"

All adjustable parameters are listed in the following table.

Parameter	Description	Unit	Adjustment range		Factory settings	Step size
			Minimum	Maximum		
Constant Q: Q	Constant reactive power in discharging mode	p.u. of S_{max}	0.0	1.0	0.436	0.001
Constant Q: Phase pos (cosPhi=cst, Q=cst)	Constant phase position in discharging mode	–	0: capacitive	1: inductive	0: capacitive	–
Abbreviations: p.u. = per unit						

Adjustable parameters for function "Q = const"

Tab. 58

More information about "Q = const"

- In the event of overvoltage or undervoltage it may occur that the set apparent power is less than the required reactive power (characteristic curve). In this case, the apparent power is automatically increased accordingly.
- The function only applies in discharging mode. In charging mode, all parameters are freely selectable.
- In addition, a PT1 behavior of the output reactive power can be activated. (see ["Switching on Step response for Q", pg. 98](#))

5.8 Step response "Step response for Q"

Function description "Step response for Q"

For changes of the reactive power, a step response can be set. This is possible with the four Q-mode functions "Q(U)", "Constant cos(Phi)", "cosPhi(P)" and "Q=const" as well as with the "RT voltage mode"function.

The step response defines the period in which the new value is reached. This allows either an abrupt or a more gradual change to be set.

The time constant τ determines the speed of the change here. After 3τ , approximately 95% of the set value is reached.

$$Q(t) = Q_{set} * \left(1 - e^{-\frac{t}{\tau}}\right)$$

Fig. 48

Switching on "Step response for Q"

1. To switch on the function:
 - In the main menu, click on >GRID CODE.
 - Select the grid code in the selection list: "EN50549-1".
2. In the "Grid code modes" area under "Activate step response for Q", select: "PT1 of Q".
The function is switched on.

Parameterization "Step response for Q"

All adjustable parameters are listed in the following table.

Parameter	Description	Unit	Adjustment range		Factory settings	Step size
			Mini-mum	Maxi-mum		
PT1 of Q: tau	τ is the time constant of the step response.	s	1.0	30.0	3.3	0.1

Adjustable parameters for function "Step response for Q"

Tab. 59

Note

The step response only affects the switching back on following a grid fault. Not in the case of normal switching on or set value changes.

Enter parameters for "Step response for Q"

1. Select >Configuration >EN50549-1.

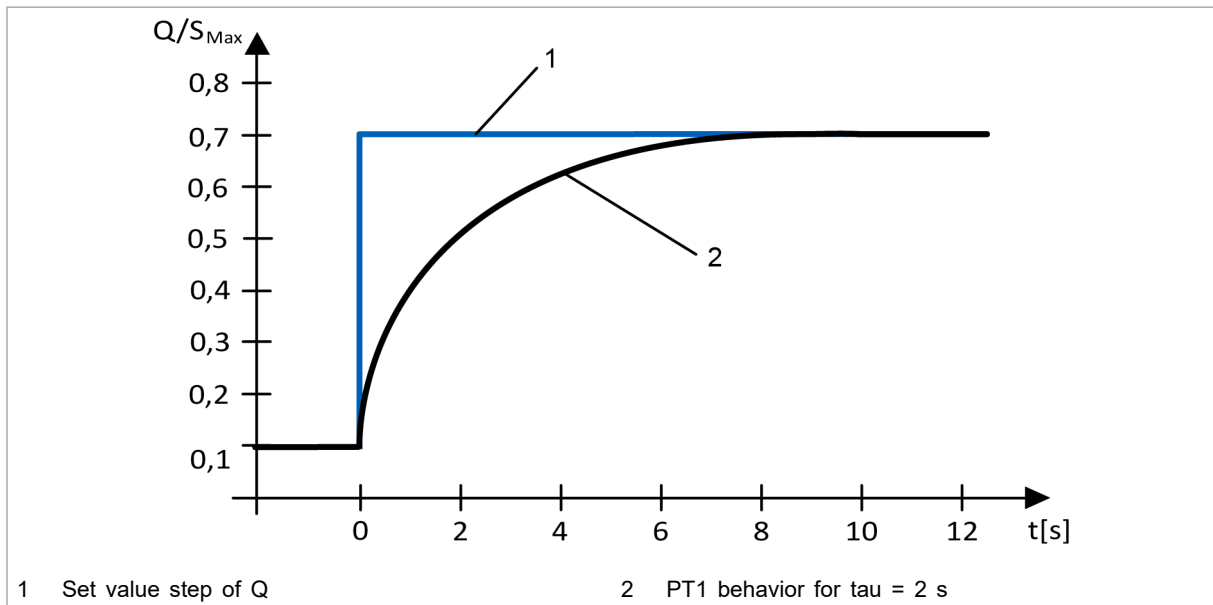

Characteristic curve for step response (example)

Fig. 49

2. In the "Step response for Q settings" area, enter the desired values in "PT1 of Q: tau".

5.9 Switch-on criteria "Switch on criteria"

Function description "Switch on criteria"

The grid voltage and grid frequency must move within a defined range for a certain period of time; only then can the AC-DC module be connected. If the conditions are not satisfied, a corresponding alarm message is displayed ("Grid does not match grid code requirements.").

The AC-DC module expects an external command in order to reconnect to the grid. Switching back on does not occur automatically.

Switching on "Switch on criteria"

1. To switch on the function:
 - In the main menu, click on >GRID CODE.
 - Select the grid code in the selection list: "EN50549-1".
2. In the "Grid code modes" area under "Switch on criteria", select: "Active".

The function is switched on.

Parameterization "Switch on criteria"

All adjustable parameters are listed in the following table.

Parameter	Description	Unit	Adjustment range		Factory settings	Step size
			Minimum	Maximum		
Voltage min	Minimum value for the grid voltage	p.u. of V_{nom}	0.5	0.99	0.85	0.01
Voltage max	Maximum value for the grid voltage	p.u. of V_{nom}	1	1.2	1.1	0.01
Frequency min	Minimum value for the grid frequency	Hz	47	50	49.5	0.1
Frequency max	Maximum value for the grid frequency	Hz	50	52	50.1	0.1
Time	Time span for the switch-on check	s	10	600	60	0.1

Possible parameter values for "Switch on criteria"

Tab. 60

Enter parameters for "Switch on criteria"

1. Select *>Configuration >EN50549-1*.
2. Enter the desired values in the "Switch on settings" area.

5.10 Startup ramp "Startup ramp"

Function description "Startup ramp"

Function "Startup ramp" ensures that the set value of the effective power is achieved with a linear ramp when connecting the device to the grid.

Switching on "Startup ramp"

1. To switch on the function:
 - In the main menu, click on *>Operation >AC-DC module settings*.
2. In the "AC-DC module settings" area under "Activate startup ramp after next power stage activation", select: "Active".

or

- Modbus ID 4282

The function is switched on.

The function can also be switched on and off during running operation.

Parameterization "Startup ramp"

All adjustable parameters are listed in the following table.

Parameter	Description	Unit	Adjustment range		Factory settings	Step size
			Minimum	Maximum		
Startup ramp slope	Slope of the startup ramp	%/min	6	3000	10	1

Adjustable parameters for function "Startup ramp"

Tab. 61

Enter parameters for "Startup ramp"

Note

Parameters cannot be changed during running operation.

1. Select *>Configuration >EN50549-1*.
2. In the "Active power limiting" area, enter the desired values in "Startup ramp slope".

More information about "Startup ramp"

The startup ramp starts when energy is fed to the grid for the first time.

The startup ramp is only active in discharging mode.

5.11 Power limiter "Active power limiting"

Function description "Active power limiting"

The "Active power limiting" function ensures that the maximum effective power P_{\max} is achieved with a linear ramp.

If the function is switched on, a maximum effective power P_{\max} can be specified for the AC-DC module.

The function actively intervenes as soon as the desired set value is greater than the set P_{\max} value. The output effective power is limited to the specified P_{\max} value and this P_{\max} value is achieved with a linear ramp. The ramp has a slope of $0.5\% \times P_{\text{nom}}$ per second.

Switching on "Active power limiting"

1. To switch on the function:
 - In the main menu, click on *>GRID CODE*.
 - Select the grid code in the selection list: "EN50549-1".
2. In the "Active power limiting" area under "Activate active power limit ramp", select: "Active".

The function is switched on.

Parameterization "Active power limiting"

All adjustable parameters are listed in the following table.

Parameter	Description	Unit	Adjustment range		Factory settings	Step size
			Minimum	Maximum		
Pmax limit (Modbus ID: 4281)	Target value of the ramp	% of P_{nom}	0.00	200.00	150.00	0.01

Adjustable parameters for function "Active power limiting"

Tab. 62

Enter parameters for "Active power limiting"

1. Select *>Configuration >EN50549-1*.
2. In the "Active power limiting" area, enter the desired values in "Pmax limit in % of Pnom".

6. TOR type A

6.1 Hierarchy of the grid code functions

If several grid code functions are active at the same time, the function with the highest hierarchy level takes control.

The P(U) function can intervene parallel to the Q modes. From the functions of the Q modes, only one function can be selected in advance. Thus, only the selected function of the Q modes can intervene.

Hierarchy	Name of the function		Meaning of the function
0	Anti-islanding		Anti-islanding protection
1	RT voltage		Dynamic grid support
2	Bypass		Reduction of the output power to 0 kVA
3	P(f)		Effective power matching in the event of overfrequency and underfrequency
4	P(U)		Effective power matching in the event of overvoltage
4	Q modes Static voltage stability/ provision of reactive power	Q(U)	Reactive-power voltage curve Q(U)
4		Constant cosPhi	Fixed power factor $\cos\phi$
4		cosPhi(P)	Power-factor/effective-power curve $\cos\phi$ (P)
4		Const Q	Constant provision of reactive power

Hierarchy of the grid code functions

Tab. 63

The individual functions are described separately in the further sections.

(See also "TOR producer type A2019-12 (connection and parallel operation of power plants of type A and of small-scale power plants)")

Grid connection rule: TOR producer type A2019-12 (connection and parallel operation of power plants of type A and of small-scale power plants)

Additional functions

Name of the function	Meaning of the function
Step response for Q	Step response behavior for reactive power Q These additional functions change the behavior of the Q(U), Constant cos(Phi), cosPhi(P) and RT voltage functions.
Switch on criteria	Switch-on criteria

Additional functions

Name of the function	Meaning of the function
Startup ramp	Startup ramp
Active power limiting	Power limiter

Additional functions

Tab. 64

6.2 Anti-islanding protection

Switching on Anti-islanding protection

If inadvertent isolated operation is detected, the AC-DC module is switched off within 2 s.

This function is always switched on if "grid-tied system" is selected. The function is active in the background no matter whether other grid code functions are activated.

1. Select *>Operation >AC-DC module settings*.
2. Under "Grid voltage", enter the grid voltage and grid frequency as well as the operating mode:
 - 400 V / 50 Hz, 480 V / 60 Hz, ...
 - Grid-tied or isolated operation

6.3 Dynamic grid support "RT voltage mode"

Function description "RT voltage mode"

The "RT voltage mode" function controls the behavior of the AC-DC module in the event of undervoltage and overvoltage on the mains grid.

Behavior in the event of extreme grid fluctuations:

- The AC-DC module remains connected to the grid. Not until the grid fluctuations exceed the defined limits for one grid period is the device disconnected from the grid after a delay time. (see "Fig. 8", pg. 30)
- The AC-DC module reduces its output apparent power to $S = 0$ kVA.

As long as the grid fluctuations are within the limit characteristic curves, the AC-DC module remains connected to the grid.

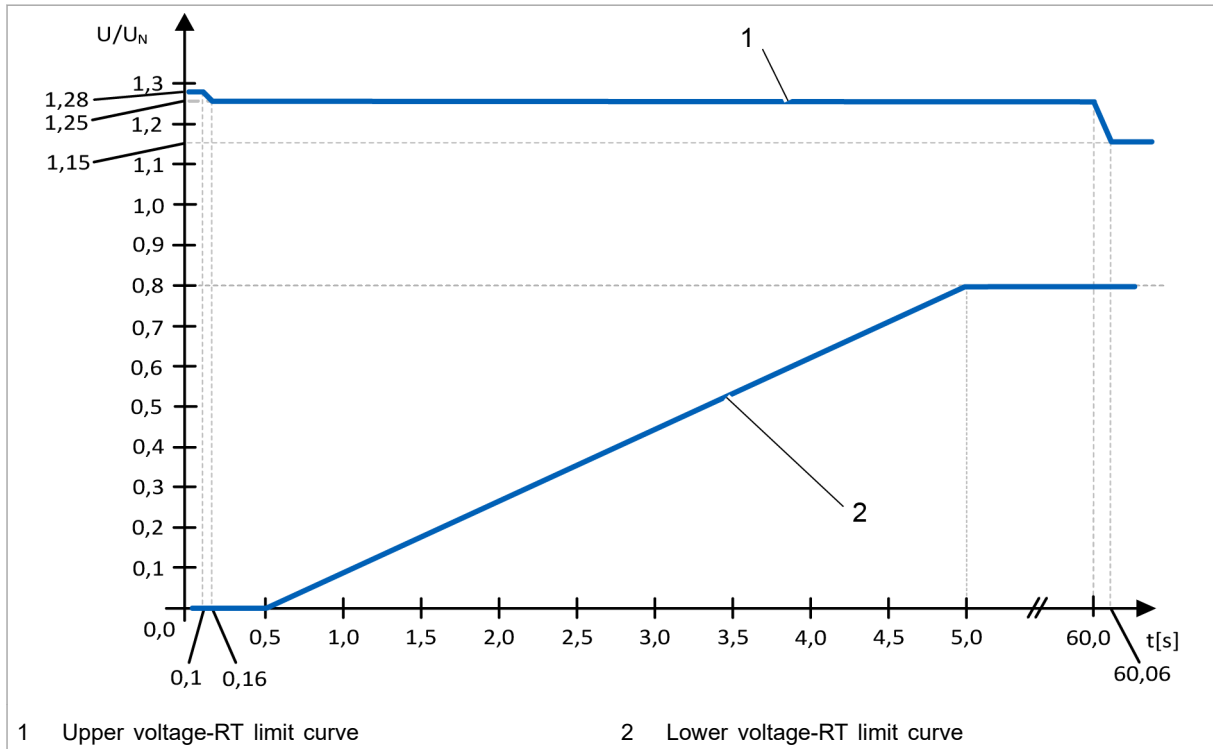

Voltage-RT limit curve of the AC-DC module

Fig. 50

Interpolation point no.	Time [s]	U [% Unom]
1	0.0	128
2	0.1	128
3	0.16	125
4	60.0	125
5	60.06	115
6	∞	115

Upper voltage RT limit curve: interpolation points for the implemented limit curve

Tab. 65

Interpolation point no.	Time [s]	U [% Unom]
1	0.0	0
2	0.5	0
3	5.0	80
4	∞	80

Lower voltage RT limit curve: interpolation points for the implemented limit curve

Tab. 66

If the grid voltage is less than 85% of U_{nom} or greater than 115% of U_{nom} , the output apparent power is reduced to 0 kVA as quickly as possible (max. 60 ms).

This is a critical grid condition and the inverter is in grid-supporting operation: apparent power S , power factor $\cos\phi$ and the phase position can no longer be changed. All entries for these

quantities are ignored as long as grid-supporting operation is active.

As soon as the grid fault has ended, the AC-DC module attempts to restore the pre-fault value. This occurs either immediately or by means of a PT1 behavior (see ["Switching on Step response for Q"](#), pg. 46).

Grid fault is ended if the outer conductor - neutral conductor voltages of the device are again within the range: $-15\% U_{nom}$ to $+15\% U_{nom}$.

The "RT voltage mode" function is active during charging and discharging mode.

Switching on "RT voltage mode"

1. To switch on the function:
 - In the main menu, click on *>GRID CODE*.
 - Select the grid code in the selection list: "TOR A".
2. In the "Grid code modes" area under "RT voltage mode", select: "Active".

The function is switched on.

In addition to this function, a step response can be set. (see ["Switching on Step response for Q"](#), pg. 46)

Parameterization "RT voltage mode"

No parameters are adjustable.

More information about "RT voltage mode"

Disconnection from the grid if the voltage drops below the minimum voltage

There is an additional limitation for the overvoltage: The battery voltage or DC link voltage present at the time of the overvoltage. The necessary battery voltage or DC link voltage is depicted as a function of the voltage increase.

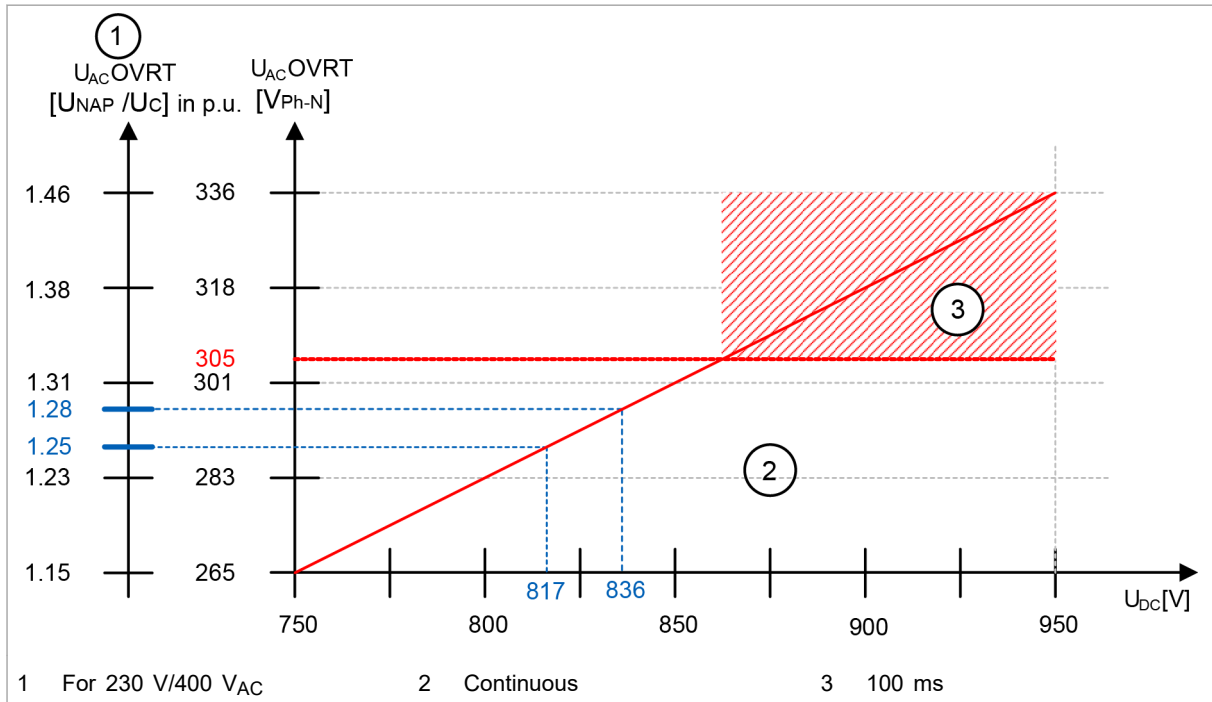

Minimum requirements for the overvoltage capability of the device

Fig. 51

If the battery voltage or DC link voltage is below the required minimum voltage during a grid-side overvoltage, there is a risk that uncontrolled current could flow from the grid towards the battery. To protect the AC-DC module and the battery, the AC-DC module disconnects itself from the grid.

To guarantee the overvoltage capability, the minimum DC link voltage must be adjusted according to the selected AC grid voltage:

- Overvoltage capability of 125%: U_{dc_min} = 817 V.
(Minimum requirement according to standard)
- Overvoltage capability of 128%: U_{dc_min} = 836 V.
(maximum overvoltage capability of the TruConvert AC 3025)

Note

If the battery is directly connected to the DC link, ensure the following:
The OCV battery voltage must be at least as large as the minimum voltage U_{dc_min}.

6.4 Bypass

Description of functions "Bypass"

The "Bypass" function immediately sets the output power to $S = 0$ kVA as soon as it is active.

Because the "Bypass" function has a higher priority than most grid codes, the power of the device can be set to $S = 0$ kVA even if a grid code is active.

Switching on "Bypass"

1. To switch on the function:
 - In the main menu, click on *>Operation >AC-DC module settings*.
2. In the "Grid code bypass function" area, select "1: Set S to 0 W".

The function is switched on.

The function can also be switched on and off during running operation.

Parameterization "Bypass"

All adjustable parameters are listed in the following table.

Parameter	Description	Unit	Adjustment range		Factory settings	Step size
			Minimum	Maximum		
Grid code bypass function (Modbus ID: 4280)	Activate/deactivate the bypass function. If active, the output power is set to $S = 0$ kVA.	–	0: Inactive	1: Set S to 0 W	0: Inactive	1

Adjustable parameters for function "Bypass"

Tab. 67

6.5 Effective power matching in the event of overfrequency

Function description "P(f) mode"

The "P(f) mode" function controls the effective power matching in the event of overfrequency.

This function allows a grid frequency that is dependent on effective power to be fed into or drawn from mains. The provided effective power follows a defined characteristic curve here.

Example characteristic curve for P(f), here with $s_{\text{Overf}} = 5\%$, $P_{\text{mom}} = 100\% \times P_{\text{b inst}}$:

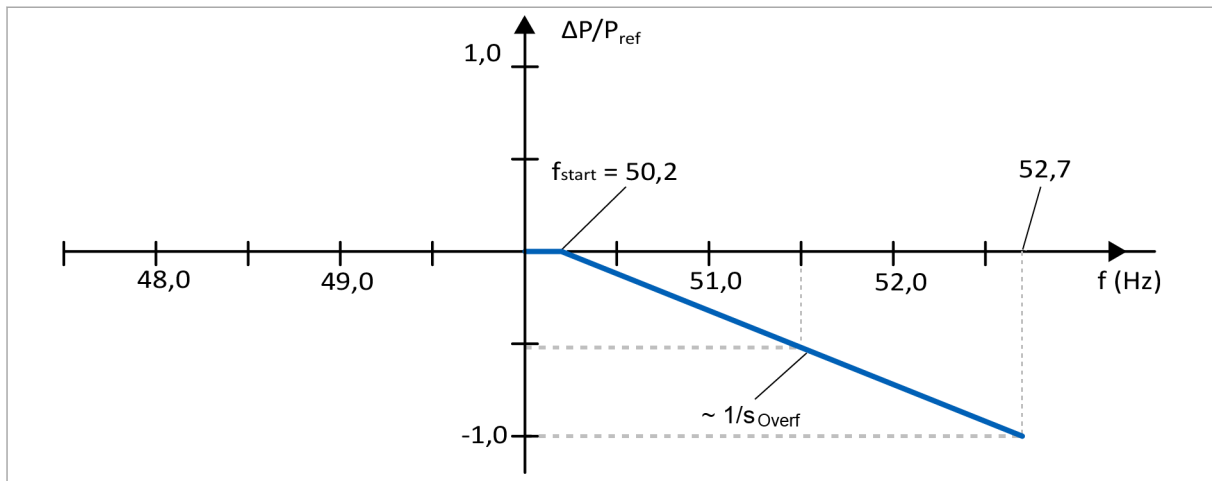

Characteristic curve of function P(f)

Fig. 52

The P(f) function actively intervenes

In normal operation, the P(f) function has no effect on the behavior of the inverter. It actively intervenes as soon as the defined tolerance band is exited. At this point in time, there is a critical grid condition and apparent power S , $\cos\phi$ power factor and the phase shift can no longer be changed. The function is active and orients itself according to the P(f) characteristic curve.

Tolerance band:

$f_{\text{Grid}} \leq \text{Overf}$: frequency start

Return to normal operation

If the grid frequency is again below the start value, the end of the critical grid condition is reached.

Requirements on the reactive power

The effective power P is specified by the P(f) characteristic curve. No requirements are placed on the reactive power, however.

To keep from further straining the grid during a critical grid condition, the reactive power is held as constant as possible. To do

this, the current reactive power is stored upon exiting the tolerance band and this value maintained.

If the maximum apparent power is not sufficient for satisfying the effective power requirement, the provided reactive power is reduced to the benefit of the effective power.

Switching on "P(f) mode"

1. To switch on the function:
 - In the main menu, click on >GRID CODE.
 - Select the grid code in the selection list: "TOR A".
2. In the "Grid code modes" area under "P(f) mode", select: "P(f)"

The function is switched on.

Parameterization "P(f) mode"

All adjustable parameters are listed in the following table.

Parameter	Description	Unit	Adjustment range		Factory settings	Step size
			Minimum	Maximum		
Overf: frequency start	Overfrequency limit	Hz	50.2	50.5	50.2	0.1
Overf: reference power	Reference for the calculation of the power reduction/increase	–	0: Maximum power	1: Momentarily power	1: Momentarily power	1
Overf: s charge	Droop of the frequency-dependent supply of effective power in the case of overfrequency during charging mode	%	2.0	12.0	5.0	0.1
Overf: s discharge	Droop of the frequency-dependent supply of effective power in the case of overfrequency during discharging mode	%	2.0	12.0	5.0	0.1
Charge_discharge_switch	If activated, it is possible to switch from charging mode to discharging mode and vice versa. If deactivated, then stop at S = 0 kVA.	–	0: No switch possible	1: Switch possible	0: No switch possible	1
Abbreviations: s = droop; f = frequency; S = apparent power						

Adjustable parameters for function P(f)

Tab. 68

Parameter	Description
Overf: frequency start	<p>This is the upper limit of the frequency tolerance band. The upper limit is adjustable within the specified value range.</p> <p>The lower limit is fixed: 49.8 Hz.</p> <p>If the grid frequency exits the tolerance band, the P(f) function takes control and adjusts the output effective power according to the set P(f) curve.</p> <p>If the upper or lower limit is reached, the value of the momentary effective power P_{mom} is stored. Here, the value P_{mom} is the average value of all 3 phases. This value P_{mom} is adjusted by the amount ΔP and thereby forms the adapted power $P_{adapted}$.</p> $P_{adapted} = P_{mom} - \Delta P$
Overf: reference power	<p>This is the reference value for the respective droop in the event of overfrequency.</p> <p>It corresponds to either the installed power P_{b_inst} or the stored power P_{mom}. Here, the installed power P_{b_inst} is equivalent to the rated effective power P_{rE}, since only one generator unit is considered.</p>
Overf: s charge Overf: s discharge	<p>These 2 droops are defined for the case of an overfrequency. Which droop is used is dependent on whether the inverter is in charging mode or discharging mode at the time the frequency is exceeded.</p> <p>The droop is adjustable within the specified value range. It corresponds to a power ramp of:</p> <ul style="list-style-type: none"> ▪ At $s = 2\% \Rightarrow 100\% P_{ref}$ per hertz ▪ At $s = 12\% \Rightarrow 16.67\% P_{ref}$ per hertz <p>P_{ref} is the reference value for the droop.</p> <p>In the event of overfrequency: $P_{ref} = P_{mom}$.</p>
Charge-discharge switch	<p>Automatic switching between charging and discharging while characteristic curve P(f) is being traversed can be permitted or prohibited.</p> <ul style="list-style-type: none"> ▪ 0: No switch possible At the time of switching, the output power at $P = 0$ kW is fixed. ▪ 1: Switch possible A change from producer to load and vice versa is permitted.

Description of the parameters

Tab. 69

Enter parameters for "P(f) mode"

1. Select >Configuration >TOR A.
2. Enter the desired values in the "P-mode settings" area.

More information about "P(f) mode"

Calculation of the adapted power

In the event of overfrequency, the power matching ΔP is calculated (abbreviations: s = droop; f = frequency):

$$\Delta P = \frac{f_{Grid} - f_{start}}{f_n} * \frac{1}{s} * P_{ref}$$

Fig. 53

In the event of underfrequency, the power matching ΔP is calculated:

$$\Delta P = \frac{f_{Grid} - 49,8 \text{ Hz}}{f_n} * \frac{1}{s} * P_{ref}$$

Fig. 54

The adapted power is then calculated:

$$P_{adapted} = P_{mom} - \Delta P$$

Fig. 55

Example

For better understanding, an example is given for overfrequency with the following parameters:

Description	Symbol	Value
Nominal frequency	f_n	50.00 Hz
Upper start frequency	f_{start}	50.20 Hz
Momentary grid frequency	f_{Grid}	51.40 Hz
Droop for overfrequency	$s = s_{discharge}$	2%
Stored value of the effective power upon reaching the upper starting frequency	$P_{ref} = P_{mom}$	80% of $P_{b \text{ inst}}$
Charge-discharge switch	–	True

Tab. 70

Reference power equal to momentary power ($P_{ref} = P_{mom}$) yields the following power matching ΔP :

$$\Delta P = \frac{51.40 - 50.20}{50} * \frac{1}{2 \%} * 0.8 * P_{b_{inst}} = 0,96 * P_{b_{inst}}$$

Fig. 56

And, thus, the following power:

$$P_{adapted} = 0.80 * P_{b_{inst}} - 0.96 * P_{b_{inst}} = -0.16 * P_{b_{inst}}$$

Fig. 57

For the given example, the power of the AC-DC module is adapted from 80% supply to 16% reference.

Upon return to the defined tolerance band and until the critical grid condition has ended, power matching occurs according to the currently measured frequency f_{Grid} (traversal of the characteristic curve).

Droops can only take positive values (grid-supporting feedback). In the event of overfrequency, the supply power is reduced or the draw from the grid increased. In the event of underfrequency, the supply power is increased or the draw from the grid reduced.

6.6 Effective power matching in the event of overvoltage "P(U) mode"

Function description "P(U) mode"

The "P(U) mode" function controls the effective power matching in the event of overvoltage.

The function reduces the effective power as a function of the applied grid voltage.

There are 2 different modes:

- "Stay on curve"
- "Limitation of maximum power"

The schematic characteristic curve appears as follows:

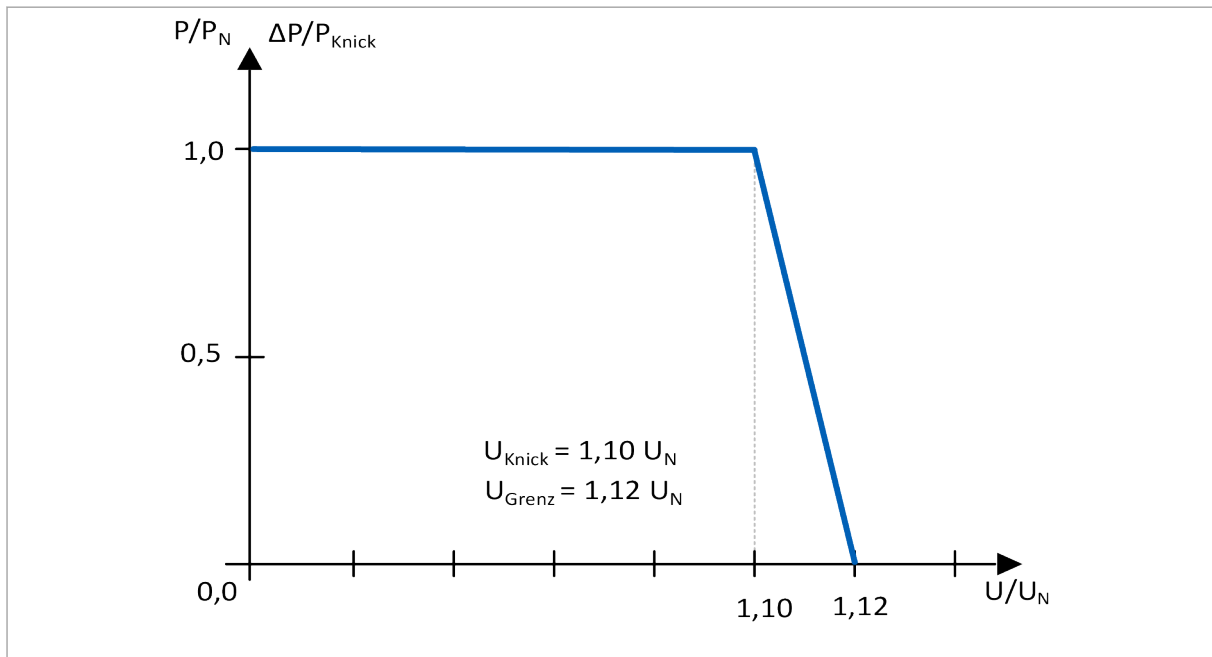

Characteristic curve of function P(U)

Fig. 58

The P(U) function actively intervenes

In normal operation, the P(U) function has no effect on the behavior of the inverter.

It actively intervenes as soon as:

- "Stay on curve":
The grid voltage exceeds the buckling voltage.
- "Limitation of maximum power":
The grid voltage exceeds the buckling voltage and, at the same time, the output effective power exceeds the power of the P(U) characteristic curve.

At this point in time, there is a critical grid condition and apparent power S , $\cos\varphi$ power factor and the phase shift can no longer be changed. The function is active and orients itself according to the P(U) characteristic curve.

Return to normal operation

The critical grid condition ends as soon as:

- "Stay on curve":
The grid voltage drops below the buckling voltage again.
- "Limitation of maximum power":
The grid voltage drops below the buckling voltage again or the output power drops below the P(U) characteristic curve again.
- The P(U) function no longer intervenes and the pre-fault value is restored.

Requirements on the reactive power

The effective power P is specified by the P(U) characteristic curve. No requirements are placed on the reactive power, however.

To keep from further straining the grid during a critical grid condition, the power factor $\cos\phi$ is held as constant as possible. For this purpose, the momentary power factor $\cos\phi$ is stored and this value maintained upon occurrence of the critical grid condition. The reduction of the effective power thereby also results in a reduction of the reactive power.

Switching on "P(U) mode"

1. To switch on the function:
 - In the main menu, click on `>GRID CODE`.
 - Select the grid code in the selection list: "TOR A".
2. In the "Grid code modes" area under "Activate P(U) mode", select: "P(U)".

The function is switched on.

Parameterization "P(U) mode"

All adjustable parameters are listed in the following table.

Parameter	Description	Unit	Adjustment range		Factory settings	Step size
			Minimum	Maximum		
Calculation mode	Selection of the calculation mode	–	0: Stay on curve	1: Limitation of maximum power	0: Stay on curve	1
Buckling voltage	Buckling voltage	p.u. of V_{nom}	1.09	1.11	1.10	0.01
Cut-off voltage	Limit voltage	p.u. of V_{nom}	1.11	1.15	1.12	0.01
Activate step response for P	Activation of a PT1 behavior for P	–	0: Inactive	1: PT1 of P	1: PT1 of P	1
PT1 of P: tau	Time constant of the step response	s	1.0	60.0	5	0.1

Adjustable parameters for function P(U)

Tab. 71

Parameter	Description
Calculation mode Buckling voltage Cut-off voltage	<p>It is possible to select between two different calculation processes:</p> <ul style="list-style-type: none"> ▪ "Stay on curve": A start voltage is defined based on the defined buckling voltage "Buckling voltage". If the grid voltage exceeds this voltage at any time, the P(U) function takes control and adapts the output effective power according to the set P(U) characteristic curve. If the buckling voltage is reached, the value of the momentary effective power P_{mom} is stored. This value P_{mom} is adjusted by the amount ΔP. The output effective power reaches its minimum $P = 0$ kW at its limit voltage "Cut-off voltage". ▪ "Limitation of maximum power": The maximum effective power output is limited. If the effective power exceeds the characteristic curve at a given point in time, the output power is limited to the value of the P(U) characteristic curve. The limitation takes effect only for grid voltages that are greater than the buckling voltage. The output effective power reaches its minimum $P = 0$ kW at its limit voltage "Cut-off voltage".
Activate step response for P PT1 of P: tau	<p>For changes of the output effective power, a step response can be set. The step response defines the period in which the new value is reached. This allows either an abrupt or a more gradual change to be set.</p> <ul style="list-style-type: none"> ▪ Switching on the PT1 behavior: <ul style="list-style-type: none"> - Set parameter "Activate step response for P" to "1: PT1 of P". - Enter time constant τ ("PT1 of P: tau"). - The time constant τ determines the speed of the change here. After 3τ, approximately 95% of the set value is reached. ▪ Switching off the PT1 behavior: Set parameter "Activate step response for P" to "0: Inactive". If the PT1 behavior is switched off, the effective power reduction takes place without delay.

Description of the parameters

Tab. 72

Enter parameters for "P(f) mode"

1. Select *>Configuration >EN50549-1*.
2. In the "P(f) mode settings" area enter the desired values.

More information about "P(U) mode"

- In addition, a PT1 behavior of the output reactive power can be activated. (see ["Switching on Step response for Q"](#), pg. 126)

6.7 Static voltage stability/provision of reactive power "Q modes"

To aid the static grid support through reactive power, one of the following processes can be selected:

- Reactive power as a function of the grid voltage: "Q(U)"
- Fixed power factor $\cos\varphi$: "Constant $\cos\Phi$ "
- Power factor as a function of effective power: "CosPhi(P)"
- Constant provision of reactive power: "Q = const"

Minimum power factor

In all reactive power processes, an attempt is made to ensure that the provided ratio of effective power to reactive power is not outside of the line delineated in blue.

This means, in particular, that with small effective powers ($P/S_r < 0.2$) there is a minimum power factor of $\cos\varphi = 0.4$. For larger effective powers, this limit value is adapted according to the blue characteristic curve. By means of this process, the maximum reactive power is limited relative to the provided effective power. The "Constant $\cos\Phi$ " function is an exception. Here, the entered power factor $\cos\varphi$ is used.

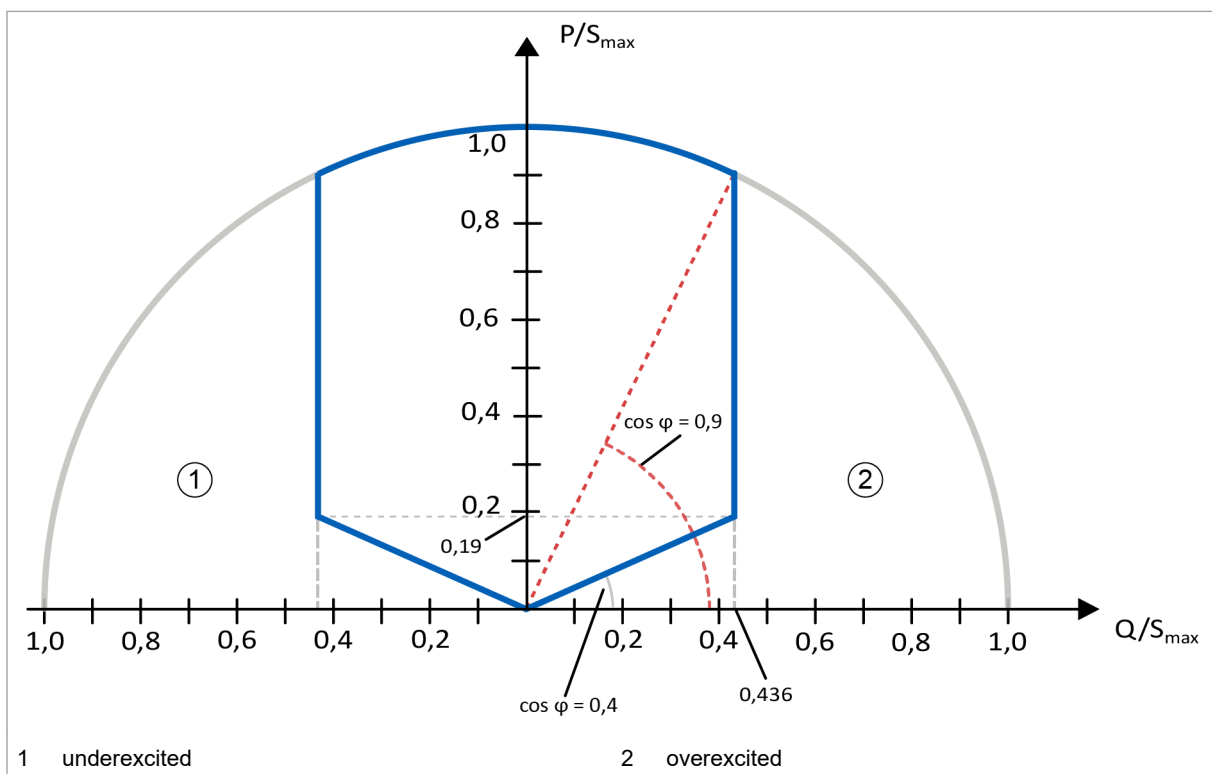

Fig. 59

Reactive power as a function of the grid voltage: "Q(U)"

Function description "Q(U)"

Function "Q(U)" controls the provision of reactive power as a function of voltage.

This function allows a grid voltage that is dependent on reactive power to be fed into or drawn from grid. The provided reactive power follows a defined characteristic curve here.

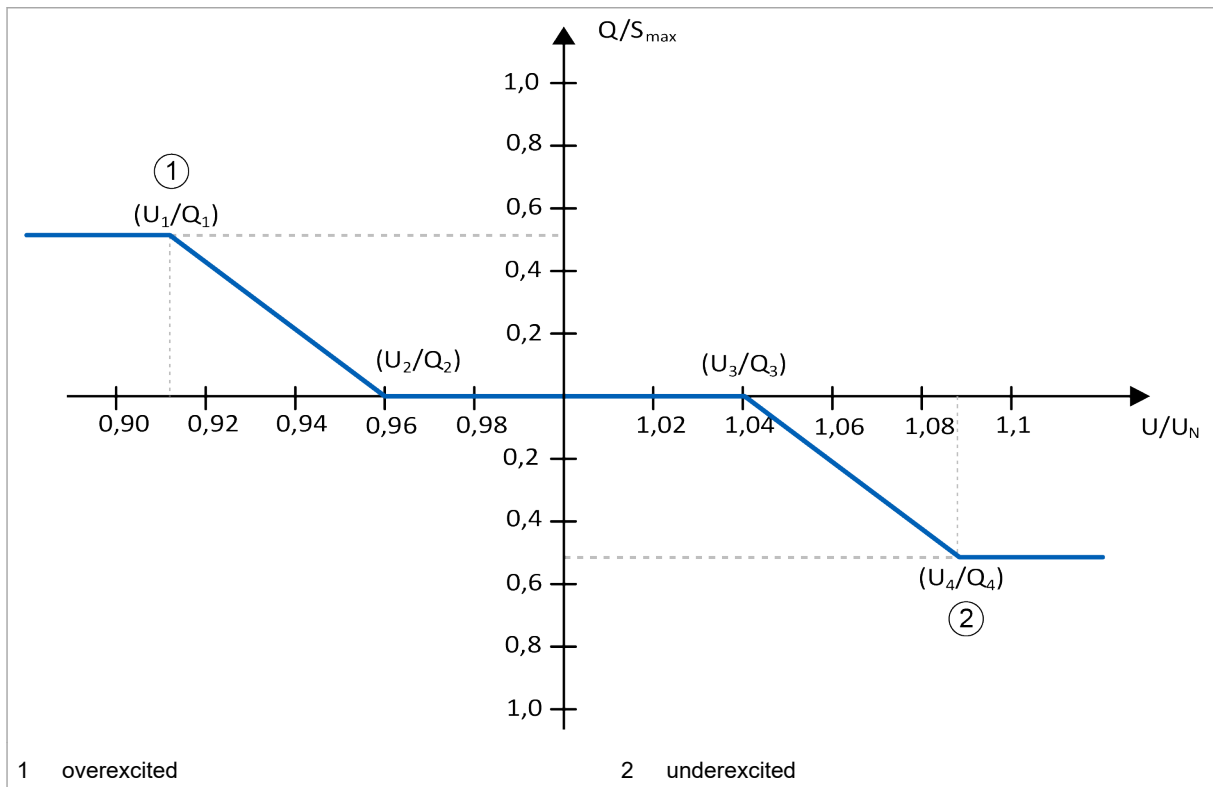

Fig. 60

Interpolation point no.	Voltage [U/U _N]	Reactive power [Q/S _{max}]
1	Voltage 1 (U1)	Q1
2	Voltage 2 (U2)	Q2
–	Unom	0.0
3	Voltage 3 (U3)	Q3 = Q2
4	Voltage 4 (U4)	Q4 = Q1

Interpolation points for the implemented characteristic curve

Tab. 73

Within which value ranges the individual interpolation points lie is defined for each parameter. (see "Parameterization Q(U)", pg. 119)

In the AC-DC module, the power factor $\cos\varphi$ and the phase position can be specified for controlling the apparent power S.

With switched-on Q(U) function, the input of the set value for the apparent power ("Set value AC") is generally interpreted as effective power P.

- In normal operation, $\cos\varphi = 1$ is set.
- In the event of fault, $\cos\varphi$ is determined from the characteristic curve. The actually delivered/consumed apparent power is then determined from the set value specification ($\triangleq P$) and $\cos\varphi$.

By means of the Q(U) characteristic curve, the values of the power factor $\cos\varphi$ and the phase position are uniquely determined from the set value specification ($\triangleq P$) and the grid voltage. For this reason, if the function is actively intervening, the entered parameters of the power factor $\cos\varphi$ and of the phase position are ignored.

The power factor $\cos\varphi$ determined from the characteristic curve is calculated from the entered set value and the specified reactive power (characteristic curve).

$$\cos\varphi = \sqrt{1 - \frac{Q^2}{P^2 + Q^2}}$$

Fig. 61

Switching on "Q(U)"

1. To switch on the function:
 - In the main menu, click on *>GRID CODE*.
 - Select the grid code in the selection list: "TOR A".
2. In the "Grid code modes" area under "Activate Q mode", select: "Q(U)".

The function is switched on.

Parameterization "Q(U)"

All adjustable parameters are listed in the following table.

Parameter	Description	Unit	Adjustment range		Factory settings	Step size
			Minimum	Maximum		
Q(U): voltage 1* U1	1st voltage interpolation point	p.u. of V_{nom}	0.85	0.94	0.92	0.01
Q(U): voltage 2* U2	2nd voltage interpolation point	p.u. of V_{nom}	0.94	0.99	0.96	0.01
Q(U): voltage 3* U3	3rd voltage interpolation point	p.u. of V_{nom}	1.01	1.06	1.05	0.01
Q(U): voltage 4* U4	4th voltage interpolation point	p.u. of V_{nom}	1.06	1.10	1.08	0.01
Q(U): Q1 and Q4	Reactive power at the 1st and 4th voltage interpolation point	p.u. of V_{nom}	0	1	0.436	0.001
*) $U_{1-4} = x \% U_{nom}$, $U_{nom} = 231 \text{ V}$						
Abbreviations: p.u. = per unit						

Adjustable parameters for function Q(U)

Tab. 74

Enter parameters for Q(U)

1. Select *>Configuration >TOR A*.
2. In the "Q mode settings" area, enter the desired values in "Q(U): ...".

More information about "Q(U)"

- In the event of overvoltage or undervoltage it may occur that the set apparent power is less than the required reactive power (characteristic curve). It is also possible that the requirement for the minimum $\cos\varphi$ is not met due to the ratio of effective power to reactive power. In this case, the apparent power is automatically increased accordingly.
- The function only applies in discharging mode. In charging mode, all parameters are freely selectable.
- In addition, a PT1 behavior of the output reactive power can be activated. (see ["Switching on Step response for Q"](#), pg. 126)

Fixed power factor "Constant cosPhi"

Function description "Constant cosPhi"

With this function, a constant power factor $\cos\varphi$ and a constant phase position for discharging mode can be specified. By means of this constant power factor, it is ensured that some reactive power is always output to the grid.

In the AC-DC module, the power factor $\cos\varphi$ and the phase position can be specified for controlling the apparent power S . By selecting the "Constant cosPhi" function, the values of $\cos\varphi$ and the phase position are, for a given apparent power, uniquely determined by the grid code settings. For this reason, if the function is actively intervening, the entered parameters of the power factor $\cos\varphi$ and of the phase position are ignored. The set values are used instead.

Set power factor $\cos\varphi$ used

With this function, the set power factor $\cos\varphi$ is used for all effective power values. Thus, values that are less than the minimum power factor $\cos\varphi = 0.4$ are also allowed in this case.

Switching on "Constant cosPhi"

- To switch on the function:
 - In the main menu, click on *>GRID CODE*.
 - Select the grid code in the selection list: "TOR A".
- In the "Grid code modes" area under "Activate Q mode", select: "Constant cos(Phi)"

The function is switched on.

Parameterization "Constant cosPhi"

All adjustable parameters are listed in the following table.

Parameter	Description	Unit	Adjustment range		Factory settings	Step size
			Minimum	Maximum		
Constant cosPhi: cosPhi	Constant power factor in discharging mode	–	0.0	1.0	0.9	0.01
Phase pos (cosPhi=cst, Q=cst)	Constant phase position in discharging mode	–	0: capacitive	1: inductive	0: capacitive	–

Adjustable parameters for function Constant cosPhi

Tab. 75

Enter parameters for "Constant cosPhi"

1. Select *>Configuration >TOR A*.
2. In the "Q mode settings" area, enter the desired values in "Constant cosPhi".

More information about "Constant cosPhi"

- The function only applies in discharging mode. In charging mode, all parameters are freely selectable.
- In addition, a PT1 behavior of the output reactive power can be activated. (see ["Switching on Step response for Q"](#), pg. 126)

Power factor as a function of effective power "cosPhi(P)"

Function description "cosPhi(P)"

Function "cosPhi(P)" controls the provision of reactive power by means of a changed power factor $\cos\varphi$ as a function of the set effective power. The function can be used to output a specified reactive power to the grid as a function of the set effective power. This is implemented as the cosPhi(S) characteristic curve.

In the AC-DC module, the power factor $\cos\varphi$ and the phase position can be specified for controlling the apparent power S. By selecting the "cosPhi(P)" function, the values of $\cos\varphi$ and the phase position are uniquely determined for a given apparent power. For this reason, if the function is actively intervening, the entered parameters of the power factor $\cos\varphi$ and of the phase position are ignored. Instead, the values of the cosPhi(S) characteristic curve are used.

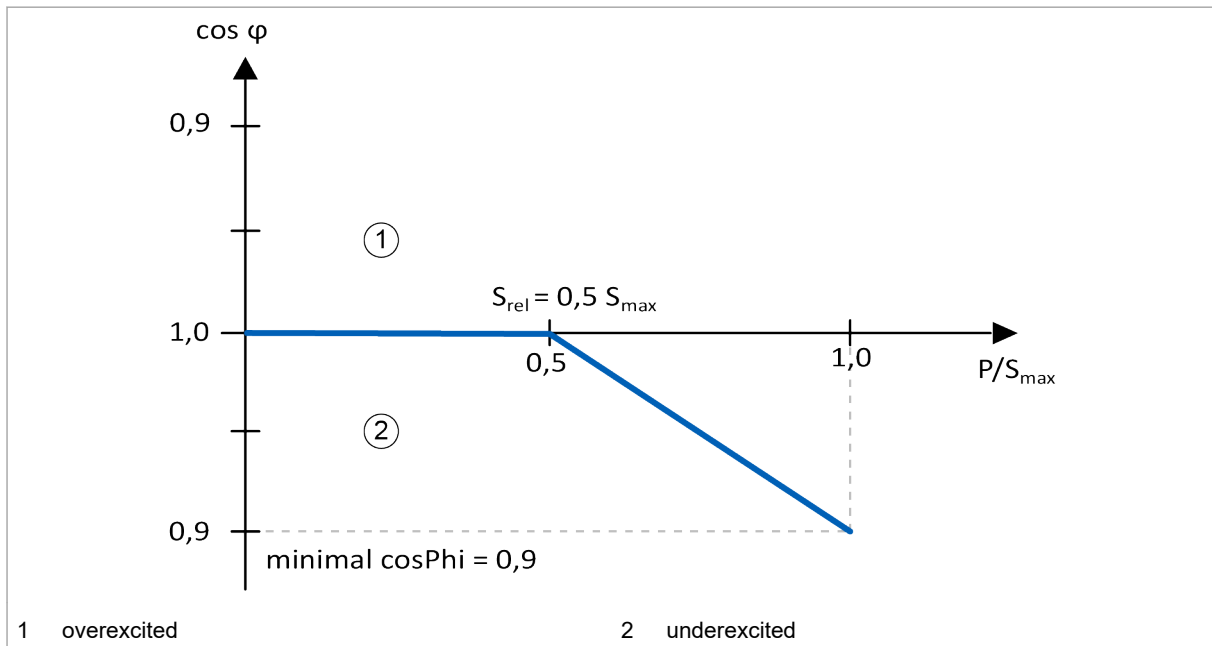

Fig. 62

Switching on "cosPhi(P)"

1. To switch on the function:
 - In the main menu, click on `>GRID CODE`.
 - Select the grid code in the selection list: "TOR A".
2. In the "Grid code modes" area under "Activate Q mode", select: "cosPhi(P)"

The function is switched on.

Parameterization "cosPhi(P)"

No parameters are adjustable.

The values are permanently set: $S_{\text{rel}} = 0.5$ and "minimal cosPhi" = 0.9.

More information about "cosPhi(P)"

- The function only applies in discharging mode. In charging mode, all parameters are freely selectable.
- In addition, a PT1 behavior of the output reactive power can be activated. (see ["Switching on Step response for Q"](#), pg. 126)

Constant provision of reactive power "Q = const"

Function description "Q = const"

The "Q = const" function controls the provision of reactive power by means of a constant reactive power value.

In the AC-DC module, the power factor $\cos\varphi$ and the phase position can be specified for controlling the apparent power S . By selecting the "Q = const" function, the values of $\cos\varphi$ and the phase position are uniquely determined for a given apparent power. For this reason, if the function is actively intervening, the entered parameters of the power factor $\cos\varphi$ and of the phase position are ignored. The set values are used instead.

Minimum power factor

With this function as well, an attempt is made to ensure that the provided ratio of effective power to reactive power is not outside of the line delineated in blue (see "Fig. 59", pg. 117). Thus, with small effective powers, the requirement on the constant reactive power is ignored and the minimum power factor $\cos\varphi = 0.4$ satisfied. Only once the effective power is large enough is the full reactive power made available.

Switching on "Q = const"

1. To switch on the function:
 - In the main menu, click on `>GRID CODE`.
 - Select the grid code in the selection list: "UL1741SA Grid Codes"
2. In the "Grid code modes" area under "Activate Q mode", select: "Constant Q"

The function is switched on.

Parameterization "Q = const"

All adjustable parameters are listed in the following table.

Parameter	Description	Unit	Adjustment range		Factory settings	Step size
			Minimum	Maximum		
Constant Q: Q	Constant reactive power in discharging mode	p.u. of S_{max}	0.0	1.0	0.436	0.001
Constant Q: Phase pos (cosPhi=cst, Q=cst)	Constant phase position in discharging mode	–	0: capacitive	1: inductive	0: capacitive	–
Abbreviations: p.u. = per unit						

Adjustable parameters for function "Q = const"

Tab. 76

More information about "Q = const"

- In the event of overvoltage or undervoltage it may occur that the set apparent power is less than the required reactive power (characteristic curve). It is also possible that the requirement for the minimum $\cos\varphi$ is not met due to the ratio of effective power to reactive power. In this case, the apparent power is automatically increased accordingly.
- The function only applies in discharging mode. In charging mode, all parameters are freely selectable.
- In addition, a PT1 behavior of the output reactive power can be activated. (see "Switching on Step response for Q", pg. 126)

6.8 Step response "Step response for Q"

Function description "Step response for Q"

For changes of the reactive power, a step response can be set. This is possible with the four Q-mode functions "Q(U)", "Constant cos(Phi)", "cosPhi(P)" and "Q=const" as well as with the "RT voltage mode"function.

The step response defines the period in which the new value is reached. This allows either an abrupt or a more gradual change to be set.

The time constant τ determines the speed of the change here. After 3τ , approximately 95% of the set value is reached.

$$Q(t) = Q_{set} * \left(1 - e^{-\frac{t}{\tau}}\right)$$

Fig. 63

Switching on "Step response for Q"

1. To switch on the function:
 - In the main menu, click on *>GRID CODE*.
 - Select the grid code in the selection list: "TOR A".
2. In the "Grid code modes" area under "Activate step response for Q", select: "PT1 of Q".

The function is switched on.

Parameterization "Step response for Q"

All adjustable parameters are listed in the following table.

Parameter	Description	Unit	Adjustment range		Factory settings	Step size
			Minimum	Maximum		
PT1 of Q: tau	τ is the time constant of the step response.	s	1.0	30.0	3.0	0.1

Adjustable parameters for function "Step response for Q"

Tab. 77

Note

The step response only affects the switching back on following a grid fault. Not in the case of normal switching on or set value changes.

Enter parameters for "Step response for Q"

1. Select *>Configuration >TOR A*.

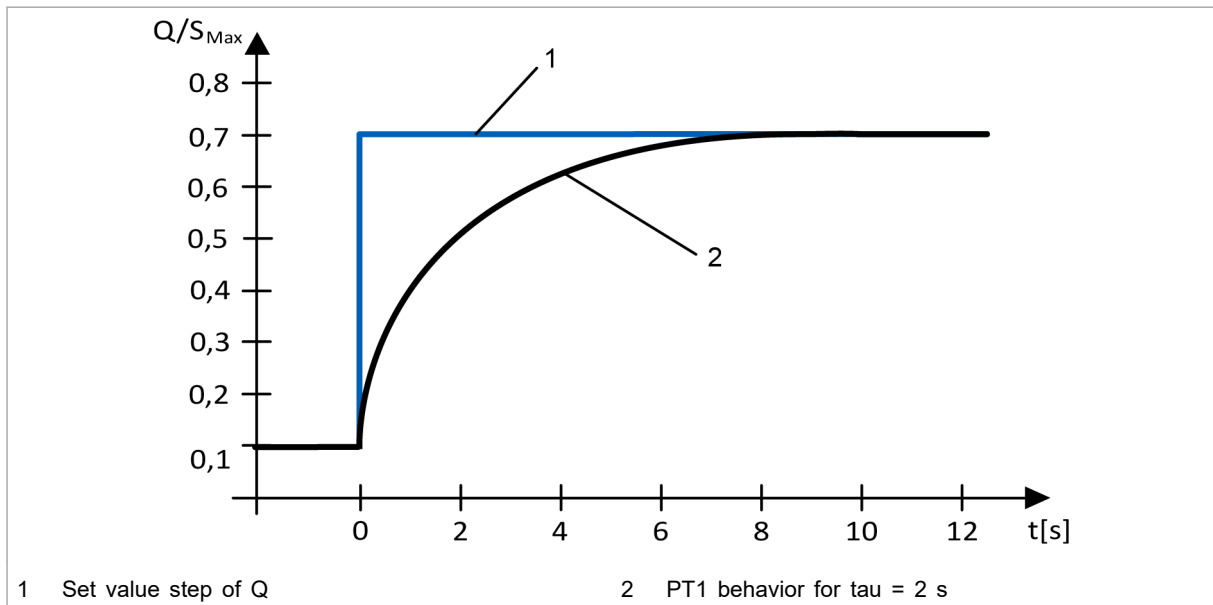

Characteristic curve for step response (example)

Fig. 64

2. In the "Step response for Q settings" area, enter the desired values in "PT1 of Q: tau".

6.9 Switch-on criteria "Switch on criteria"

Function description "Switch on criteria"

The grid voltage and grid frequency must move within a defined range for a certain period of time; only then can the AC-DC module be connected. If the conditions are not satisfied, a corresponding alarm message is displayed ("Grid does not match grid code requirements.").

The AC-DC module expects an external command in order to reconnect to the grid. Switching back on does not occur automatically.

Switching on "Switch on criteria"

1. To switch on the function:
 - In the main menu, click on *>GRID CODE*.
 - Select the grid code in the selection list: "TOR A".
2. In the "Grid code modes" area under "Switch on criteria", select: "Active".

The function is switched on.

Parameterization "Switch on criteria"

All adjustable parameters are listed in the following table.

Parameter	Description	Unit	Adjustment range		Factory settings	Step size
			Minimum	Maximum		
Voltage min	Minimum value for the grid voltage	p.u. of V_{nom}	0.8	0.99	0.85	0.01
Voltage max	Maximum value for the grid voltage	p.u. of V_{nom}	1	1.15	1.09	0.01
Frequency min	Minimum value for the grid frequency	Hz	47	50	47.5	0.1
Frequency max	Maximum value for the grid frequency	Hz	50	52	50.1	0.1
Time	Time span for the switch-on check	s	10	300	60	0.1

Possible parameter values for "Switch on criteria"

Tab. 78

Enter parameters for "Switch on criteria"

1. Select *>Configuration >TOR A*.
2. Enter the desired values in the "Switch on settings" area.

6.10 Startup ramp "Startup ramp"

Function description "Startup ramp"

Function "Startup ramp" ensures that the set value of the effective power is achieved with a linear ramp when connecting the device to the grid.

Switching on "Startup ramp"

1. To switch on the function:
 - In the main menu, click on *>Operation >AC-DC module settings*.
2. In the "AC-DC module settings" area under "Activate startup ramp after next power stage activation", select: "Active".

or

- Modbus ID 4282

The function is switched on.

The function can also be switched on and off during running operation.

Parameterization "Startup ramp"

All adjustable parameters are listed in the following table.

Parameter	Description	Unit	Adjustment range		Factory settings	Step size
			Mini- mum	Maxi- mum		
Startup ramp slope	Slope of the startup ramp	%/min	6	3000	10	1

Adjustable parameters for function "Startup ramp"

Tab. 79

Enter parameters for "Startup ramp"

Note

Parameters cannot be changed during running operation.

1. Select *>Configuration >TOR A*.
2. In the "Active power limiting" area, enter the desired values in "Startup ramp slope".

More information about "Startup ramp"

The startup ramp starts when energy is fed to the grid for the first time.

The startup ramp is only active in discharging mode.

6.11 Power limiter "Active power limiting"

Function description "Active power limiting"

The "Active power limiting" function ensures that the maximum effective power P_{\max} is achieved with a linear ramp.

If the function is switched on, a maximum effective power P_{max} can be specified for the AC-DC module.

The function actively intervenes as soon as the desired set value is greater than the set P_{max} value. The output effective power is limited to the specified P_{max} value and this P_{max} value is achieved with a linear ramp. The ramp has a slope of $0.5\% \times P_{nom}$ per second.

Switching on "Active power limiting"

1. To switch on the function:
 - In the main menu, click on *>GRID CODE*.
 - Select the grid code in the selection list: "TOR A".
2. In the "Active power limiting" area under "Activate active power limit ramp", select: "Active".

The function is switched on.

Parameterization "Active power limiting"

All adjustable parameters are listed in the following table.

Parameter	Description	Unit	Adjustment range		Factory settings	Step size
			Minimum	Maximum		
Pmax limit (Modbus ID: 4281)	Target value of the ramp	% of P_{nom}	0.00	200.00	150.00	0.01

Adjustable parameters for function "Active power limiting"

Tab. 80

Enter parameters for "Active power limiting"

1. Select *>Configuration >TOR A*.
2. In the "Active power limiting" area, enter the desired values in "Pmax limit in % of Pnom".

7. AS/NZS 4777.2

7.1 Hierarchy of the grid code functions

If several grid code functions are active at the same time, the function with the highest hierarchy level takes control.

From the functions of the Q modes, only one function can be selected in advance. Thus, only the selected function of the Q modes can intervene.

The other functions with the same hierarchy level can operate in parallel.

Hierarchy	Name of the function		Meaning of the function
0	Anti-islanding		Anti-islanding protection
1	Voltage limit mode (passive anti islanding protection)		Dynamic grid support
1	Frequency limit mode (passive anti islanding protection)		Dynamic grid support
1	Sustained operation voltage mode		Shutdown in the event of overvoltage
2	P(f): Sustained operation frequency mode		Effective power matching in the event of overfrequency and underfrequency
3	P(U): Volt-watt response modes		Effective power matching in the event of overvoltage and undervoltage
3	Q modes Static voltage stability/ provision of reactive power	Q(U): Volt-var response mode	Reactive-power voltage curve Q(U)
3		Constant cosPhi: Fixed power factor mode	Fixed power factor $\cos\phi$
3		Constant Q: Reactive power mode	Fixed reactive power

Hierarchy of the grid code functions

Tab. 81

The individual functions are described separately in the further sections.

(See also "AS/NZS 4777.2 – Grid connection of energy systems via inverters".)

Additional functions

Name of the function	Meaning of the function
Switch on criteria	Switch-on criteria
Startup ramp	Startup ramp

Additional functions

Tab. 82

7.2 Anti-islanding protection

Switching on Anti-islanding protection

If inadvertent isolated operation is detected, the AC-DC module is switched off within 2 s.

This function is always switched on if "grid-tied system" is selected. The function is active in the background no matter whether other grid code functions are activated.

1. Select *>Operation >AC-DC module settings*.
2. Under "Grid voltage", enter the grid voltage and grid frequency as well as the operating mode:
 - 400 V / 50 Hz, 480 V / 60 Hz, ...
 - Grid-tied or isolated operation

7.3 Regional settings ("Regional settings")

Depending on the country or region of a country in which the device is operated, certain specifications are to be observed.

Possible regions:

- Australia A
- Australia B
- Australia C
- New Zealand
- Custom

If necessary, inquire with grid operator as to which region must be selected for the given system location.

If one of the specified regions is selected, all parameters are already clearly defined (see factory settings).

If Custom is selected, the parameters can be manually set within the specified minimum and maximum values.

Select "Regional settings"

1. To switch on the function:
 - In the main menu, click on *>Configuration*.
 - Select the grid code in the selection list: "AS/NZS 4777.2".
2. In the "Regional settings" area, enter the desired country region under "Region".

All parameters predefined for this region are used. Depending on the selected region, selection options in the submenus are either limited or already set to fixed values.

7.4 "Voltage limit mode" (passive anti islanding protection)

Function description "Voltage limit mode"

The "Voltage limit mode" function controls the behavior of the AC-DC module in the event of undervoltage and overvoltage on the mains grid.

Behavior in the event of extreme grid fluctuations:

- The AC-DC module remains connected to the grid. Not until the grid fluctuations exceed the defined limits for one grid period is the device disconnected from the grid after a delay time. (see "Fig. 65", pg. 134)
- The AC-DC module reduces its output apparent power to $S = 0$ kVA.

As long as the grid fluctuations are within the limit characteristic curves, the AC-DC module remains connected to the grid.

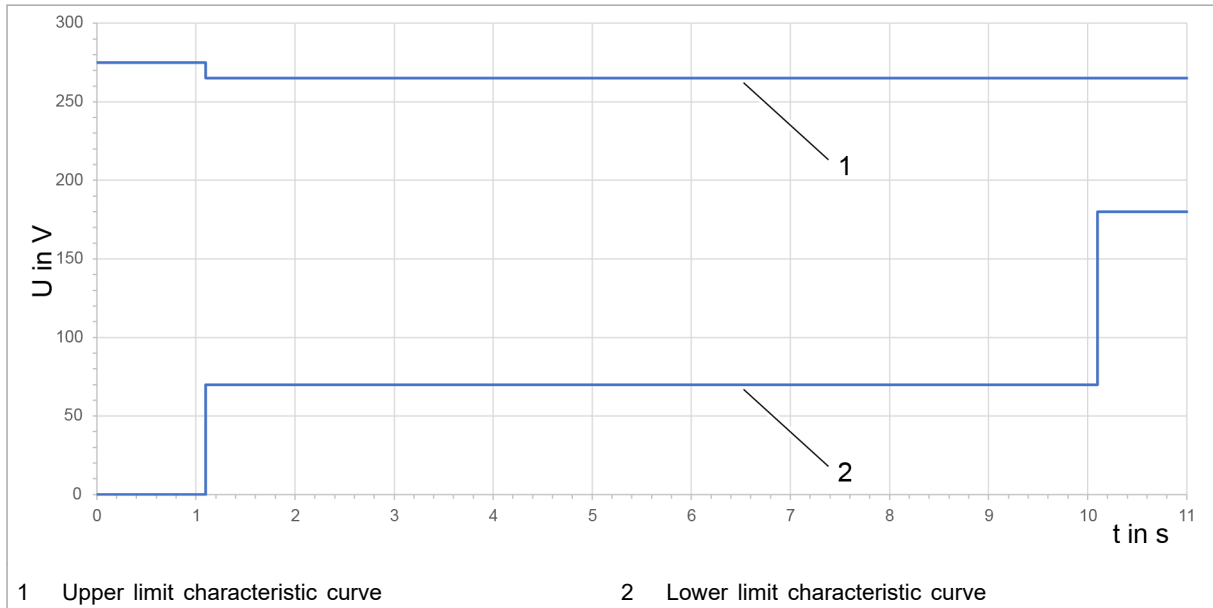

Voltage limit mode: limit characteristic curve of the AC-DC module

Fig. 65

Protective function	U	Delay time
Undervoltage 2 (V <<)	70 V	1.1 s
Undervoltage 1 (V <)	180 V	10.1 s
Overvoltage 1 (V >)	265 V	1.1 s
Overvoltage 2 (V >>)	275 V	–

Upper and lower voltage limit characteristic curve: interpolation points for the implemented limit characteristic curves

Tab. 83

If the grid voltage is less than 180 V or greater than 260 V, the output apparent power is reduced to 0 kVA as quickly as possible (max. 60 ms).

Voltage limits	Inverter response
> 260 V	Cease power generation
180 V to 260 V	Continuous operation
< 180 V	Cease power generation

Response to voltage faults

Tab. 84

This is a critical grid condition and the inverter is in grid-supporting operation: effective power P, reactive power Q and the phase position can no longer be changed. All entries for these quantities are ignored as long as grid-supporting operation is active.

If the grid voltage is again within the range of 180 V – 260 V, the grid fault is ended and the AC-DC module attempts to restore the pre-fault value as quickly as possible.

The "Voltage limit mode" function is active during charging and discharging mode.

Switching on "Voltage limit mode"

1. To switch on the function:
 - In the main menu, click on *>Configuration*.
 - Select the grid code in the selection list: "AS/NZS 4777.2".
2. In the "Grid code modes" area under "Voltage limit mode", select: "Active".

The function is switched on.

Parameterization "Voltage limit mode"

No parameters are adjustable.

More information about "Voltage limit mode"

Multiple voltage disturbances

"Voltage limit mode" supports multiple successive voltage drops. All voltage drops within 15 s are considered to be related here. The durations of all voltage drops that occurred within the last 15 s are added together. This sum is compared to the respective delay time. If the grid is stable for 15 s without interruption, the summed times are reset to 0 s and all subsequent voltage drops are treated as a new fault.

Disconnection from the grid if the voltage drops below the minimum voltage

There is an additional limitation for the overvoltage: The battery voltage or DC link voltage present at the time of the overvoltage. The necessary battery voltage or DC link voltage is depicted as a function of the voltage increase.

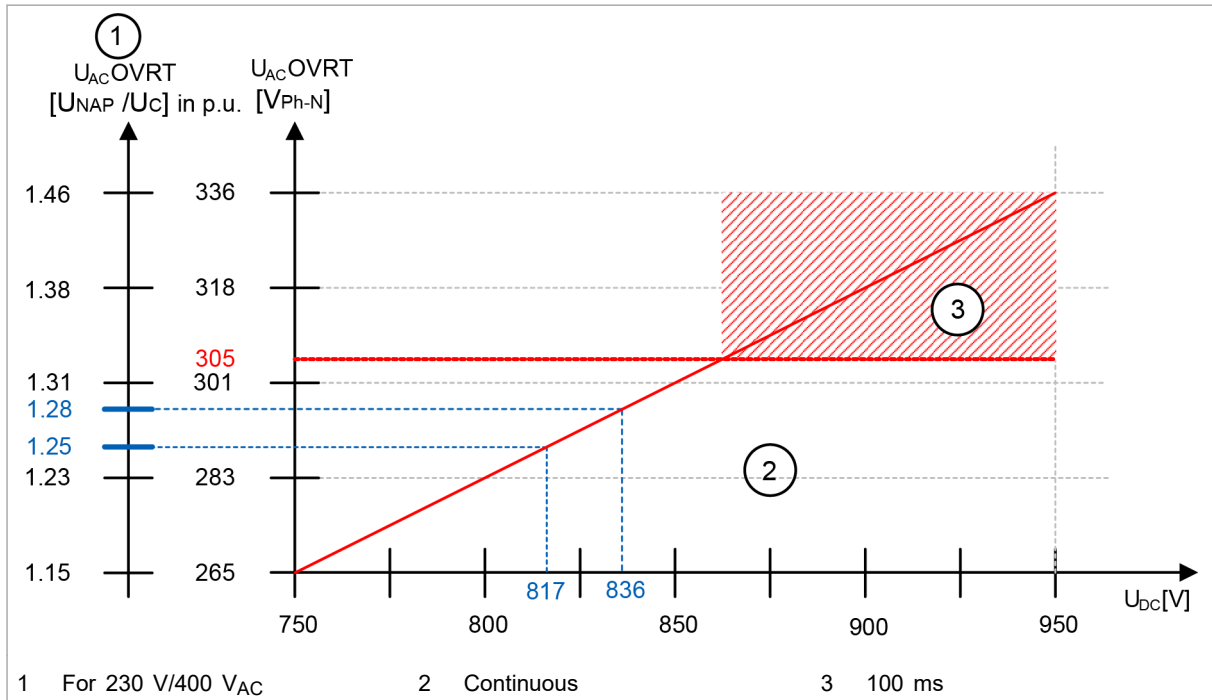

Minimum requirements for the overvoltage capability of the device

Fig. 66

If the battery voltage or DC link voltage is below the required minimum voltage during a grid-side overvoltage, there is a risk that uncontrolled current could flow from the grid towards the battery. To protect the AC-DC module and the battery, the AC-DC module disconnects itself from the grid.

To guarantee the overvoltage capability, the minimum DC link voltage must be adjusted according to the selected AC grid voltage:

- Overvoltage capability of 120% (corresponds ≈ 275 V):
Udc_min = 784 V.
(Minimum requirement according to standard)
- Overvoltage capability of 128%: Udc_min = 836 V.
(maximum overvoltage capability of the TruConvert AC 3025)

Note

If the battery is directly connected to the DC link, ensure the following:

The OCV battery voltage must be at least as large as the minimum voltage Udc_min.

7.5 Frequency limit mode (passive anti islanding protection)

Function description "Frequency limit mode"

The "Frequency limit mode" function controls the behavior of the AC-DC module in the event of undervoltage and overvoltage on the mains grid.

Behavior in the event of extreme grid fluctuations:

- The AC-DC module remains connected to the grid. Not until the grid fluctuations exceed the defined limits for one grid period is the device disconnected from the grid after a delay time. (see "Fig. 67", pg. 137)
- The AC-DC module reduces its output apparent power to $S = 0$ kVA.

As long as the grid fluctuations are within the limit characteristic curves, the AC-DC module remains connected to the grid.

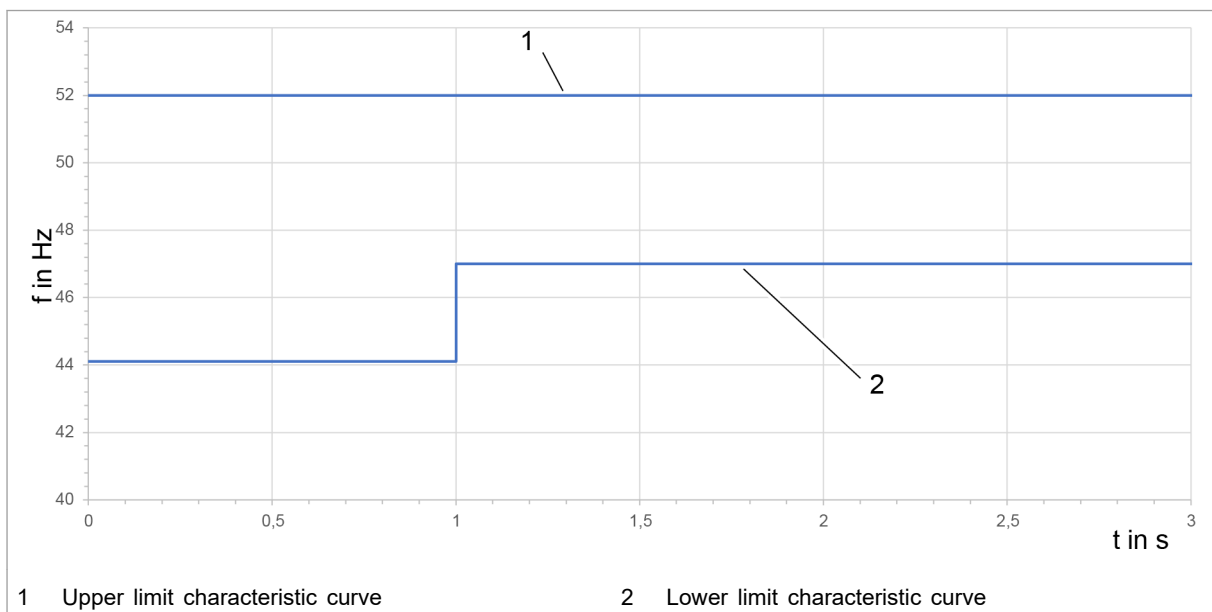

Frequency limit mode: limit characteristic curve of the AC-DC module (example for Australia A)

Fig. 67

	Region	Australia A	Australia B	Australia C	New Zealand
Underfrequency (F <)	Limit value [Hz]	47	47	45	45
	Delay time [s]	1	1	5	1

	Region	Australia A	Australia B	Australia C	New Zealand
Overfrequency (F >)	Limit value [Hz]	52	52	55	55
	Delay time [s]	–	–	–	–

Upper and lower frequency limit characteristic curve: interpolation points for the implemented limit characteristic curves Tab. 85

If the grid frequency is below 44.1 Hz, the inverter disconnects itself from the grid.

The "Frequency limit mode" function is active during charging and discharging mode.

Switching on "Frequency limit mode"

1. To switch on the function:
 - In the main menu, click on >Configuration.
 - Select the grid code in the selection list: "AS/NZS 4777.2".
2. In the "Grid code modes" area under "Frequency limit mode", select: "Active".

The function is switched on.

Parameterization "Frequency limit mode"

All adjustable parameters are listed in the following table.

Parameter	Description	Unit	Adjustment range		Factory settings	Step size
			Minimum	Maximum		
Over-frequency 1 (F >) value	Overfrequency limit	Hz	52	55	Australia A: 52 Australia B: 52 Australia C: 55 New Zealand: 55	0.1
Under-frequency 1 (F >) value	Underfrequency limit	Hz	45	47	Australia A: 47 Australia B: 47 Australia C: 45 New Zealand: 45	0.1
Under-frequency 1 (F <) trip delay time	Time delay until the device disconnects itself from the grid.	s	1	5	Australia A: 1 Australia B: 1 Australia C: 5 New Zealand: 1	0.1

Adjustable parameters for function "Frequency limit mode" Tab. 86

Enter parameters for "Frequency limit mode"

1. Select *>Configuration >AS/NZS 4777.2*.
2. In the "Regional settings" area, select the corresponding region under "Region".
All parameters are thereby clearly defined.
3. To manually set the parameters:
 - In the "Regional settings" area under "Region", select "Customer".
 - Enter the desired values in the "Voltage and frequency limit mode settings" area.

7.6 Sustained operation voltage mode

Function description "Sustained operation voltage mode"

The "Sustained operation voltage mode" function is used to monitor the grid voltage over a time period of 10 min. If the 10 minute mean value exceeds the set limit value, the AC-DC module disconnects itself from the grid.

The limit values are dependent on the respective region.

Region	Limit value $V_{nom-max}$	Step size
Australia A	258 V	–
Australia B	258 V	–
Australia C	258 V	–
New Zealand	249 V	–
Permissible range	244 V to 258 V	0.1

Preset limit values for $V_{nom-max}$

Tab. 87

The "Sustained operation voltage mode" function is active during charging and discharging mode.

Switching on "Sustained operation voltage mode"

1. To switch on the function:
 - In the main menu, click on *>Configuration*.
 - Select the grid code in the selection list: "AS/NZS 4777.2".

- In the "Grid code modes" area under "Sustained operation voltage mode", select: "Activate".

The function is switched on.

Parameterization "Sustained operation voltage mode"

All adjustable parameters are listed in the following table.

Parameter	Description	Unit	Adjustment range		Factory settings	Step size
			Minimum	Maximum		
10 minute $V_{nom-max}$ value	Limit value for the 10 minute mean value of V_{nom} .	V	244	258	Australia A: 258 Australia B: 258 Australia C: 258 New Zealand: 249	0.1

Adjustable parameters for function "Sustained operation voltage mode"

Tab. 88

Enter parameters for "Sustained operation voltage mode"

- Select >Configuration >AS/NZS 4777.2.
- Enter the desired values in the "Voltage and frequency limit mode settings" area.

7.7 "P(f): Sustained operation frequency mode"

Function description "P(f): Sustained operation frequency mode"

The "P(f): Sustained operation frequency mode" function controls the effective power matching in the event of overfrequency and underfrequency.

This function allows a grid frequency that is dependent on effective power to be fed into or drawn from mains. The provided effective power follows a defined characteristic curve here.

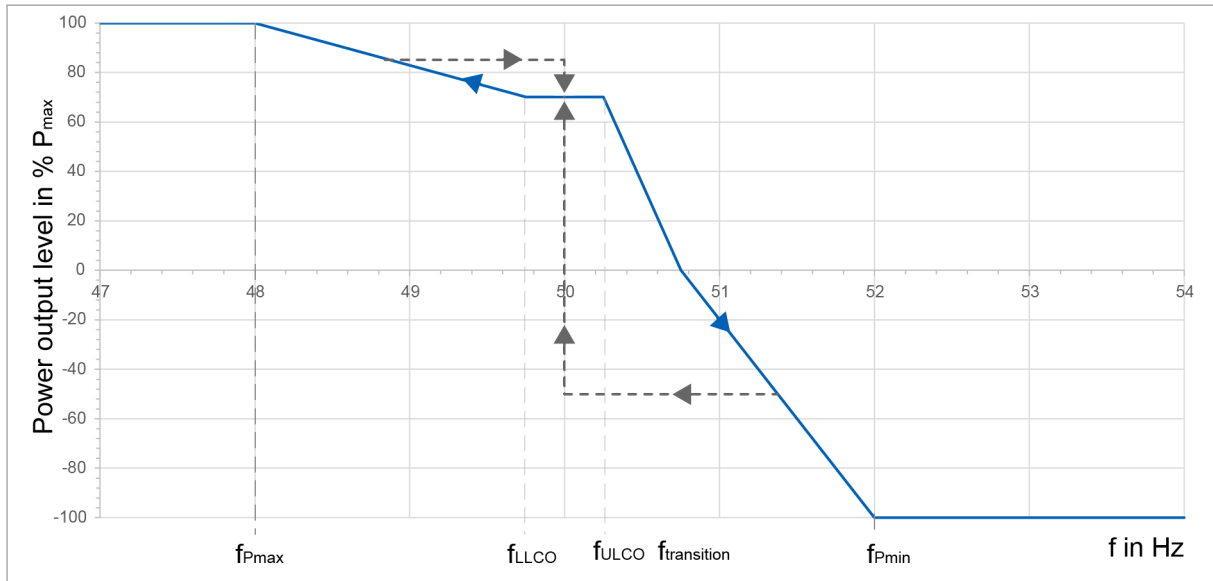

Discharging: characteristic curve of function P(f) using region Australia A as an example

Fig. 68

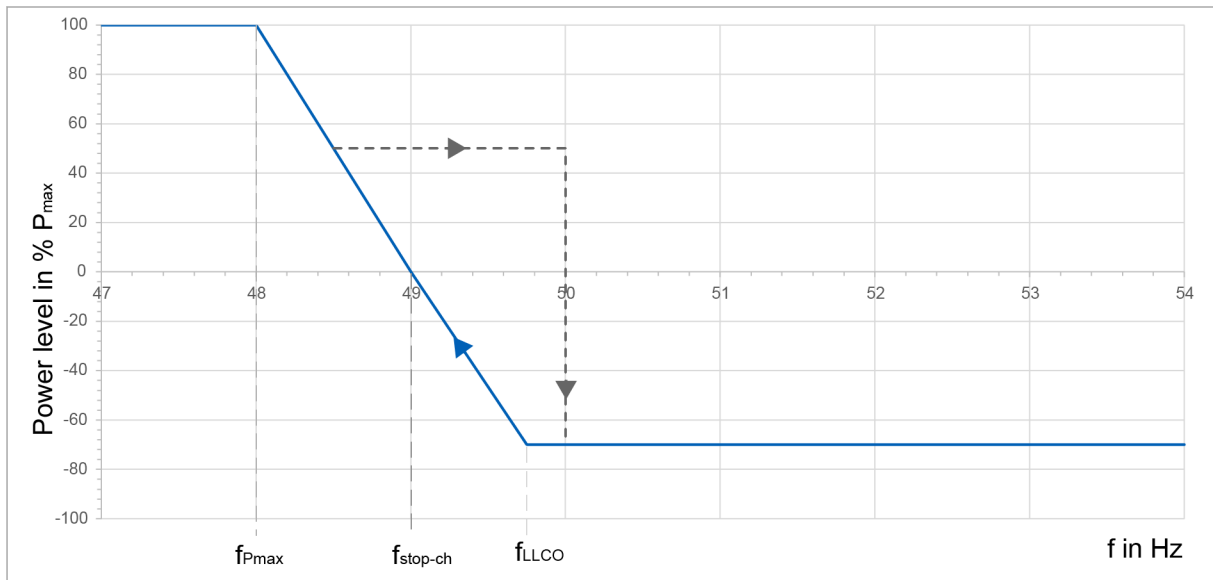

Charging: characteristic curve of function P(f) using region Australia A as an example

Fig. 69

The P(f) function actively intervenes

In normal operation, the P(f) function has no effect on the behavior of the inverter. It actively intervenes as soon as the defined tolerance band is exited. At this point in time, there is a critical grid condition and effective power P can no longer be changed. The function is active and orients itself according to the P(f) characteristic curve.

Tolerance band:

$$f_{LLCO} \leq f_{Grid} \leq f_{ULCO}$$

Return to normal operation

If the grid frequency is again within the defined tolerance band for 20 s (taking the hysteresis into account), the critical grid state is ended.

Tolerance band for return to normal operation:

$$f_{LLCO} + f_{hyst} \leq f_{Grid} \leq f_{ULCO} - f_{hyst}$$

If the conditions for return to normal operation are maintained, the power value changes with the slope "WGra".

The inverter output power is thereby fixed at the highest value between f_{LLCO} and f_{Pmax} until the function again returns to normal operation. If the frequency exceeds $f_{LLCO} + f_{hyst}$ for at least 20 seconds, the inverter returns to normal operation. Furthermore, the deviations of the power value must not exceed the slope "WGra".

Requirements on the reactive power

The effective power P is specified by the $P(f)$ characteristic curve. No requirements are placed on the reactive power, however.

To keep from further straining the grid during a critical grid condition, the reactive power is held as constant as possible. To do this, the current reactive power is stored upon exiting the tolerance band and this value maintained.

If the maximum apparent power is not sufficient for satisfying the effective power requirement, the provided reactive power is reduced to the benefit of the effective power.

Switching on "P(f): Sustained operation frequency mode"

1. To switch on the function:
 - In the main menu, click on *>Configuration*.
 - Select the grid code in the selection list: "AS/NZS 4777.2".
2. In the "Grid code modes" area under "P(f): Sustained operation frequency mode", select: "Active".

The function is switched on.

Parameterization "P(f): Sustained operation frequency mode"

All adjustable parameters are listed in the following table.

Parameter	Description	Unit	Adjustment range		Factory settings	Step size
			Minimum	Maximum		
f_LLCO	Lower limit of continuous operation range.	Hz	49.5	49.9	Australia A: 49.75 Australia B: 49.85 Australia C: 49.50 New Zealand: 49.80	0.01
f_ULCO	Lower limit of continuous operation range.	Hz	50.10	50.50	Australia A: 50.25 Australia B: 50.15 Australia C: 50.50 New Zealand: 50.20	0.01
f_Pmax	Frequency where power output level is maximum.	Hz	47.00	49.00	Australia A: 48.00 Australia B: 48.00 Australia C: 47.00 New Zealand: 48.00	0.01
f_stop-ch	Frequency where charging power level is zero.	Hz	48.00	49.50	Australia A: 49.00 Australia B: 49.00 Australia C: 48.25 New Zealand: 49.00	0.01
f_transition	Frequency where discharging power level is zero.	Hz	50.50	52.00	Australia A: 50.75 Australia B: 50.75 Australia C: 51.75 New Zealand: 51.00	0.01
f_Pmin	Frequency where power level is minimum.	Hz	51.00	53.00	Australia A: 52.00 Australia B: 52.00 Australia C: 52.00 New Zealand: 52.00	0.01
f_hyst	Values for hysteresis margin	Hz	0.00	0.20	Australia A: 0.10 Australia B: 0.10 Australia C: 0.05 New Zealand: 0.10	0.01
Allows to switch from discharge to charge	Permit switching from discharging to charging.	–	0: No switch possible	1: Switch possible	0: No switch possible	1
Allows to switch from charge to discharge	Permit switching from charging to discharging.	–	0: No switch possible	1: Switch possible	0: No switch possible	1
Startup ramp slope: W_Gra	Slope of the startup ramp	%/min	5	100	16.67	0.01

Adjustable parameters for function "P(f): Sustained operation frequency mode"

Parameter	Description
f_LLCO	This is the lower limit of the frequency tolerance band. Depending on the selected region, the lower limit is defined or can be set within the specified value range. If the grid frequency exits the tolerance band, the P(f) function takes control and adjusts the output effective power according to the set P(f) curve.
f_ULCO	This is the upper limit of the frequency tolerance band. Depending on the selected region, the upper limit is defined or can be set within the specified value range. If the grid frequency exits the tolerance band, the P(f) function takes control and adjusts the output effective power according to the set P(f) curve.
Allows to switch from discharge to charge Allows to switch from charge to discharge	Automatic switching between charging and discharging or discharging and charging while characteristic curve P(f) is being traversed can be permitted or prohibited. <ul style="list-style-type: none"> ▪ No switch possible At the time of switching, the output power at P = 0 kW is fixed. ▪ Switch possible A change from producer to load or from load to producer is permitted.

Description of the parameters

Tab. 90

Enter parameters for "P(f): Sustained operation frequency mode"

1. Select >Configuration >AS/NZS 4777.2.
2. Enter the desired values in the "P(f): Sustained operation frequency mode settings" area.

7.8 P(U): Volt-watt response modes

Function description "P(U): Volt-watt response modes"

The "P(U): Volt-watt response modes" function limits the maximum effective power that can be supplied to or consumed by the grid as a function of voltage.

The maximum effective power is within the marked limit curves at all times.

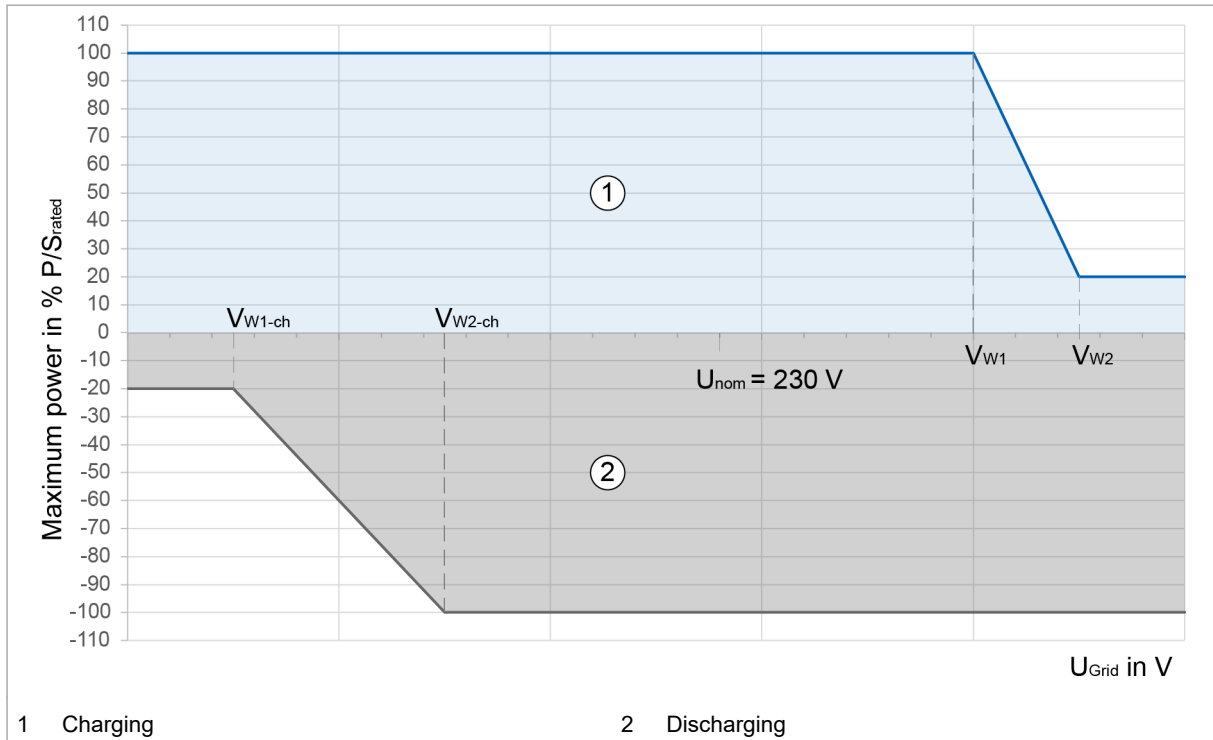

"P(U): Volt-watt response modes": limit characteristic curves of the maximum effective power

Fig. 70

Switching on "P(U): Volt-watt response modes"

1. To switch on the function:
 - In the main menu, click on >Configuration.
 - Select the grid code in the selection list: "AS/NZS 4777.2".
2. In the "Grid code modes" area under "P(U): Volt-watt response modes", select:
 - "P(U) discharge only"
 - "P(U) charge only"
 - "P(U) discharge and charge"

The function is switched on.

Parameterization "P(U): Volt-watt response modes"

All adjustable parameters are listed in the following table.

Parameter	Description	Unit	Adjustment range		Factory settings	Step size
			Minimum	Maximum		
VW1	1st voltage interpolation point in the discharging case	V	235	255	Australia A: 253 Australia B: 250 Australia C: 253 New Zealand: 242	0.1
VW2	2nd voltage interpolation point in the discharging case	V	240	265	Australia A: 260 Australia B: 260 Australia C: 260 New Zealand: 250	0.1
P(VW2)	Maximum effective power at 2nd voltage interpolation point in the discharging case	% of S_{rated}	0	20	Australia A: 20 Australia B: 20 Australia C: 20 New Zealand: 20	0.1
VW1-CH	1st voltage interpolation point in the charging case	V	180	230	Australia A: 207 Australia B: 195 Australia C: 207 New Zealand: 216	0.1
P(VW1-CH)	Maximum effective power at 1st voltage interpolation point in the charging case	% of S_{rated}	0	20	Australia A: 20 Australia B: 0 Australia C: 20 New Zealand: 20	0.1
VW2-CH	2nd voltage interpolation point in the charging case	V	180	230	Australia A: 215 Australia B: 215 Australia C: 215 New Zealand: 224	0.1

Adjustable parameters for function "P(U): Volt-watt response modes"

Tab. 91

Enter parameters for "P(U): Volt-watt response modes"

1. Select >Configuration >AS/NZS 4777.2.
2. Enter the desired values in the "P(U): Volt-watt response mode settings" area.

More information about "P(U): Volt-watt response modes"

Depending on the setting of parameter "P(U): Volt-watt response modes", the function is only active in charging mode, in discharging mode or in charging and discharging mode.

7.9 Static voltage stability/provision of reactive power "Q modes"

To aid the static grid support through reactive power, one of the following processes can be selected:

- Q(U): Volt-var response mode
- Constant cosPhi: Fixed power factor mode
- Constant Q: Reactive power mode

In the AC-DC module, no reactive power set values can be pre-set if standard AS/NZS4777.2 is selected and if Q-mode is activated as these are explicitly defined by the selected function.

Q(U): Volt-var response mode

Function description "Q(U): Volt-var response mode"

Function "Q(U): Volt-var response mode" controls the provision of reactive power as a function of voltage.

This function allows a grid voltage that is dependent on reactive power to be fed into or drawn from grid. The provided reactive power follows a defined characteristic curve here.

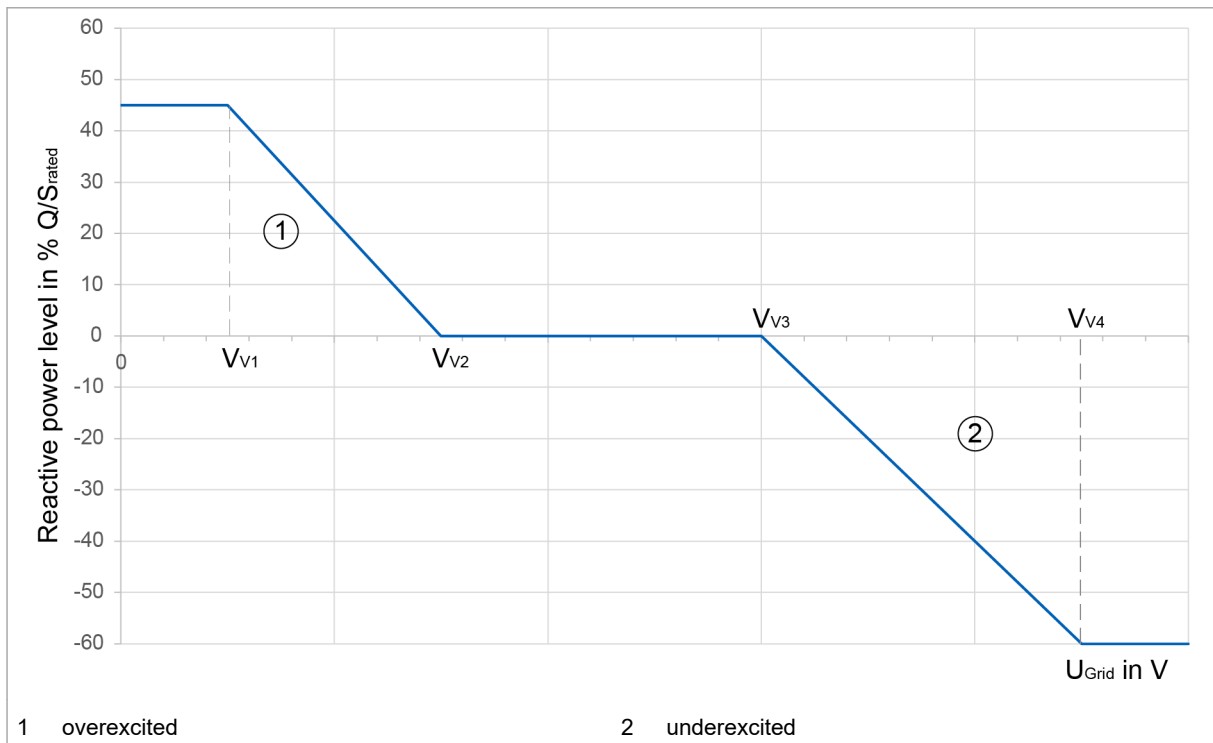

Fig. 71

Within which value ranges the individual interpolation points lie is defined for each parameter. (see "Parameterization Q(U):Volt-var response mode", pg. 148)

In the AC-DC module, no reactive power set values can be pre-set if standard AS/NZS4777.2 is selected and if Q-mode is activated as these are explicitly defined by the selected function.

Switching on "Q(U):Volt-var response mode"

1. To switch on the function:
 - In the main menu, click on >Configuration.
 - Select the grid code in the selection list: "AS/NZS 4777.2".
2. In the "Grid code modes" area under "Q modes", select: "Q(U): Volt-var response mode".
The function is switched on.

Parameterization "Q(U):Volt-var response mode"

All adjustable parameters are listed in the following table.

Parameter	Description	Unit	Adjustment range		Factory settings	Step size
			Minimum	Maximum		
Q(U): VV1*	1st voltage interpolation point	V	180	230	Australia A: 207 Australia B: 205 Australia C: 215 New Zealand: 207	0.1
Q(U): Q(VV1)*	Reactive power at 1st voltage interpolation point	% of S _{rated}	30	60	Australia A: 44 Australia B: 30 Australia C: 44 New Zealand: 60	0.1
Q(U): VV2*	2nd voltage interpolation point	V	180	230	Australia A: 220 Australia B: 220 Australia C: 230 New Zealand: 220	0.1
Q(U): VV3*	3rd voltage interpolation point	V	230	265	Australia A: 240 Australia B: 235 Australia C: 240 New Zealand: 235	0.1

Parameter	Description	Unit	Adjustment range		Factory settings	Step size
			Minimum	Maximum		
Q(U): VV4*	4th voltage interpolation point	V	230	265	Australia A: 258 Australia B: 255 Australia C: 255 New Zealand: 244	0.1
Q(U): Q(VV4)*	Reactive power at 4th voltage interpolation point	% of S_{rated}	30	60	Australia A: 60 Australia B: 40 Australia C: 60 New Zealand: 60	0.1
Charge-discharge activation	Setting that specifies when the function is active: in charging mode, in discharging mode or in charging and discharging mode.	–	<ul style="list-style-type: none"> ▪ Discharge only ▪ Charge only ▪ Discharge and charge 		Q mode discharging and charging	–

Adjustable parameters for function "Q(U):Volt-var response mode"

Tab. 92

Enter parameters for "Q(U):Volt-var response mode"

1. Select >Configuration >AS/NZS 4777.2.
2. Enter the desired values in the "Q mode settings" area.

More information about "Volt-var response mode"

- In the event of overvoltage or undervoltage, it is possible that the maximum possible apparent power is not sufficient for providing the desired effective power set value and the required reactive power. In this case, the desired effective power is reduced.
- Depending on the setting of parameter "Charge-discharge activation", the function is only active in charging mode, in discharging mode or in charging and discharging mode.

Constant cosPhi: Fixed power factor mode

Function description "Constant cosPhi: Fixed power factor mode"

With this function, a constant power factor $\cos\phi$ and a constant phase position can be specified. By means of this constant

power factor, it is ensured that some reactive power is always output to the grid.

Switching on "Constant cosPhi: Fixed power factor mode"

1. To switch on the function:
 - In the main menu, click on *>Configuration*.
 - Select the grid code in the selection list: "AS/NZS 4777.2".
 2. In the "Grid code modes" area under "Q modes", select: "Constant cos(Phi): Fixed power factor mode".
- The function is switched on.

Parameterization "Constant cosPhi: Fixed power factor mode"

All adjustable parameters are listed in the following table.

Parameter	Description	Unit	Adjustment range		Factory settings	Step size
			Minimum	Maximum		
Charge-discharge activation	Setting that specifies when the function is active: in charging mode, in discharging mode or in charging and discharging mode.	–	<ul style="list-style-type: none"> ▪ Discharge only ▪ Charge only ▪ Discharge and charge 		Q mode discharging and charging	–
Constant cosPhi: cosPhi	Constant power factor	–	0.0	1.0	0.9	0.01
Phase pos (cosPhi=cst, Q=cst)	Constant phase position	–	inductive (under-excited)	capacitive (over-excited)	inductive (under-excited)	–

Adjustable parameters for function "Constant cosPhi: Fixed power factor mode"

Tab. 93

Enter parameters for "Constant cosPhi: Fixed power factor mode"

1. Select *>Configuration >AS/NZS 4777.2*.
2. Enter the desired values in the "Q mode settings" area.

More information about "Constant cosPhi: Fixed power factor mode"

Depending on the setting of parameter "Charge-discharge activation", the function is only active in charging mode, in discharging mode or in charging and discharging mode.

Constant Q: Reactive power mode

Function description "Constant Q: Reactive power mode"

With this function, a constant reactive power and a constant phase position can be specified. By means of this constant reactive power value, it is ensured that some reactive power is always output to the grid.

Switching on "Constant Q: Reactive power mode"

1. To switch on the function:
 - In the main menu, click on *>Configuration*.
 - Select the grid code in the selection list: "AS/NZS 4777.2".
2. In the "Grid code modes" area under "Q modes", select: "Constant Q: Reactive power mode".

The function is switched on.

Parameterization "Constant Q: Reactive power mode"

All adjustable parameters are listed in the following table.

Parameter	Description	Unit	Adjustment range		Factory settings	Step size
			Minimum	Maximum		
Charge-discharge activation	Setting that specifies when the function is active: in charging mode, in discharging mode or in charging and discharging mode.	–	<ul style="list-style-type: none"> ▪ Discharge only ▪ Charge only ▪ Discharge and charge 		Q mode discharging and charging	–
Constant Q: Q	Constant reactive power value	% of S_{rated}	0.0	100.0	0.0	0.1
Phase pos (cosPhi=cst, Q=cst)	Constant phase position	–	inductive (under-excited)	capacitive (over-excited)	inductive (under-excited)	–

Adjustable parameters for function "Constant Q: Reactive power mode"

Tab. 94

Enter parameters for "Constant Q: Reactive power mode"

1. Select >Configuration >AS/NZS 4777.2.
2. Enter the desired values in the "Q mode settings" area.

More information about "Constant Q: Reactive power mode"

Depending on the setting of parameter "Charge-discharge activation", the function is only active in charging mode, in discharging mode or in charging and discharging mode.

7.10 Switch-on criteria "Switch on criteria"

Function description "Switch on criteria"

The grid voltage and grid frequency must move within a defined range for a certain period of time; only then can the AC-DC module be connected. If the conditions are not satisfied, a corresponding alarm message is displayed ("Grid does not match grid code requirements.").

The AC-DC module expects an external command in order to reconnect to the grid. Switching back on does not occur automatically.

Switching on "Switch on criteria"

1. To switch on the function:

- In the main menu, click on *>Configuration*.
 - Select the grid code in the selection list: "AS/NZS 4777.2".
2. In the "Grid code modes" area under "Switch on criteria", select: "Active".
- The function is switched on.

Parameterization "Switch on criteria"

All adjustable parameters are listed in the following table.

Parameter	Description	Unit	Adjustment range		Factory settings	Step size
			Minimum	Maximum		
Voltage min	Minimum value for the grid voltage	p.u. of V_{nom}	0.75	0.99	0.89	0.01
Voltage max	Maximum value for the grid voltage	p.u. of V_{nom}	1.01	1.15	1.10	0.01
Frequency min	Minimum value for the grid frequency	Hz	44.0	49.9	47.5	0.01
Frequency max	Maximum value for the grid frequency	Hz	50.1	56.0	50.15	0.01
Time	Time span for the switch-on check	s	0.0	300.0	60.0	0.1

Possible parameter values for "Switch on criteria"

Tab. 95

Enter parameters for "Switch on criteria"

1. Select *>Configuration >AS/NZS 4777.2*.
2. Enter the desired values in the "Switch on settings" area.

More information about "Switch on criteria"

In addition to the conditions for the "Switch on criteria" function, the conditions for the "Sustained operation for voltage variations" function must also be satisfied. (see ["Sustained operation voltage mode"](#), pg. 139)

7.11 Startup ramp "Startup ramp"

Function description "Startup ramp"

Function "Startup ramp" ensures that the set value of the effective power is achieved with a linear ramp when connecting the device to the grid.

Switching on "Startup ramp"

1. To switch on the function:
 - In the main menu, click on *>Configuration*.
 - Select the grid code in the selection list: "AS/NZS 4777.2".
2. In the "Grid code modes" area under "Startup ramp after next power stage activation", select: "Active".
The function is switched on.

Parameterization "Startup ramp"

All adjustable parameters are listed in the following table.

Parameter	Description	Unit	Adjustment range		Factory settings	Step size
			Minimum	Maximum		
Startup ramp slope: W_Gra	Slope of the startup ramp	%/min	5	100	16.67	0.01

Adjustable parameters for function "Startup ramp"

Tab. 96

Enter parameters for "Startup ramp"

1. Select *>Configuration >AS/NZS 4777.2*.
2. In the "Active power limiting" area, enter the desired values in "Startup ramp slope".

More information about "Startup ramp"

The startup ramp starts when energy is fed to the grid for the first time.

The startup ramp is only active in discharging mode.

